



■ Features :

- Universal AC input / Full range
- Protections: Short circuit / Over current / Over voltage
- Built-in active PFC function
- Cooling by free air convection
- Class 2 power unit
- Output current level adjustable
- 100% full load burn-in test
- High reliability
- Suitable for built-in applications of LED lighting
- 2 years warranty



SPECIFICATION

| MODEL | PLP-60-12 | PLP-60-24 | PLP-60-48 | |
|--------------|---|--|--------------|--------------|
| OUTPUT | DC VOLTAGE | 12V | 24V | 48V |
| | CONSTANT CURRENT REGION Note.5 | 9 ~ 12V | 18 ~ 24V | 36 ~ 48V |
| | RATED CURRENT | 5A | 2.5A | 1.3A |
| | CURRENT RANGE | 0 ~ 5A | 0 ~ 2.5A | 0 ~ 1.3A |
| | RATED POWER | 60W | 60W | 62.4W |
| | RIPPLE & NOISE (max.) Note.2 | 4.5Vp-p | 4.5Vp-p | 4.8Vp-p |
| | CURRENT ADJ. RANGE | 3.75 ~ 5A | 1.875 ~ 2.5A | 0.975 ~ 1.3A |
| | VOLTAGE TOLERANCE Note.3 | ± 10% | | |
| | LINE REGULATION | ± 3.0% | | |
| | LOAD REGULATION | ± 5.0% | | |
| SETUP TIME | 500ms / 230VAC 1200ms / 115VAC at full load | | | |
| INPUT | VOLTAGE RANGE Note.4 | 90 ~ 264VAC | | |
| | FREQUENCY RANGE | 47 ~ 63Hz | | |
| | POWER FACTOR (Typ.) | PF ≥ 0.9 at 75 ~ 100% load, 115VAC / 230VAC | | |
| | EFFICIENCY (Typ.) | 84% | 88% | 89% |
| | AC CURRENT (Typ.) | 0.8A/115VAC 0.4A/230VAC | | |
| | INRUSH CURRENT (max.) | COLD START 35A(twidth=55µs measured at 50% Ipeak) at 230VAC | | |
| | LEAKAGE CURRENT | <0.75mA / 240VAC | | |
| PROTECTION | OVER CURRENT Note.5 | 100 ~ 110% Protection type : Constant current limiting, recovers automatically after fault condition is removed | | |
| | SHORT CIRCUIT | Hiccup mode, recovers automatically after fault condition is removed | | |
| | OVER VOLTAGE | 15 ~ 18V | 28 ~ 35V | 57 ~ 63V |
| | | Protection type : Shut down o/p voltage, re-power on to recover | | |
| ENVIRONMENT | WORKING TEMP. | -30 ~ +70°C (Refer to "Derating Curve") | | |
| | WORKING HUMIDITY | 20 ~ 95% RH non-condensing | | |
| | STORAGE TEMP., HUMIDITY | -40 ~ +80°C, 10 ~ 95% RH | | |
| | TEMP. COEFFICIENT | ± 0.03%/°C (0 ~ 50°C) | | |
| | VIBRATION | 10 ~ 500Hz, 2G 12min./1cycle, period for 72min. each along X, Y, Z axes | | |
| SAFETY & EMC | SAFETY STANDARDS | UL8750, TUV EN61347-1, EN61347-2-13, CSA C22.2 No. 250.0-08(except for 48V) approved ; design refer to UL60950-1 | | |
| | WITHSTAND VOLTAGE | I/P-O/P:3.75KVAC I/P-FG:2KVAC O/P-FG:0.5KVAC | | |
| | ISOLATION RESISTANCE | I/P-O/P, I/P-FG, O/P-FG:100M Ohms / 500VDC / 25°C / 70% RH | | |
| | EMC EMISSION | Compliance to EN55015, EN61000-3-2 Class C(≥ 75% load); EN61000-3-3 | | |
| | EMC IMMUNITY | Compliance to EN61000-4-2,3,4,5,6,8,11, EN55024, EN61547, light industry level, criteria A | | |
| OTHERS | MTBF | 583.3K hrs min. MIL-HDBK-217F (25°C) | | |
| | DIMENSION | 101.6*50.8*29.6mm (L*W*H) | | |
| | PACKING | 0.16Kg; 96pcs/16.4Kg/0.89CUFT | | |
| NOTE | <ol style="list-style-type: none"> 1. All parameters NOT specially mentioned are measured at 230VAC input, rated load and 25°C of ambient temperature. 2. Ripple & noise are measured at 20MHz of bandwidth by using a 12" twisted pair-wire terminated with a 0.1µf & 47µf parallel capacitor. 3. Tolerance : includes set up tolerance, line regulation and load regulation. 4. Derating may be needed under low input voltage. Please check the static characteristics for more details. 5. Please refer to "DRIVING METHODS OF LED MODULE". 6. Heat sink HS1, HS2 can not be shorted. 7. Heat sink HS1 must have safety isolation distance with system case. 8. The power supply is considered as a component that will be operated in combination with final equipment. Since EMC performance will be affected by the complete installation, the final equipment manufacturers must re-qualify EMC Directive on the complete installation again. 9. Direct connecting to LEDs is suggested, but is not suitable for using additional drivers. 10. To fulfill requirements of the latest ErP regulation for lighting fixtures, this LED power supply can only be used behind a switch without permanently connected to the mains. | | | |

Mechanical Specification

Unit:mm

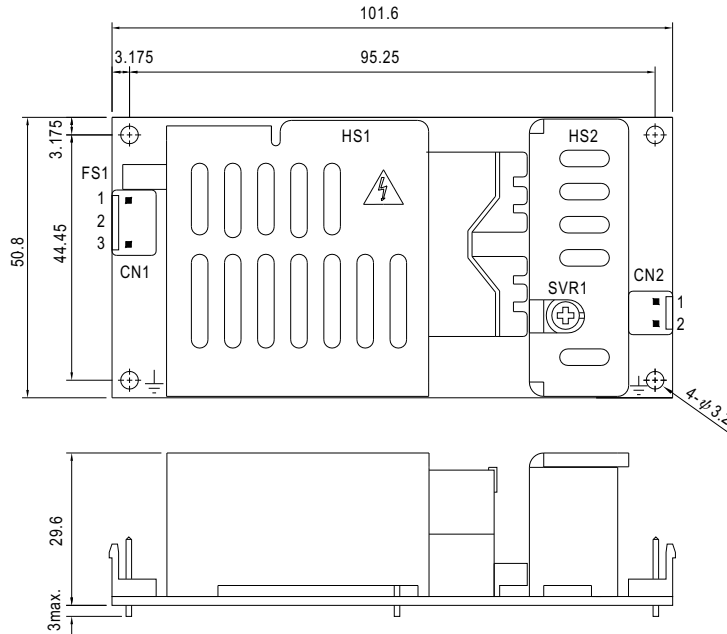

- ⚠ 1.HS1,HS2 can not be shorted.
- ⚠ 2.HS1 must have safety isolation distance with system case.

AC Input Connector (CN1) : JST B3P-VH or equivalent

| Pin No. | Assignment | Mating Housing | Terminal |
|---------|------------|-----------------------|--------------------------------|
| 1 | AC/L | JST VHR or equivalent | JST SVH-21T-P1.1 or equivalent |
| 2 | No Pin | | |
| 3 | AC/N | | |

DC Output Connector (CN2) : JST B2P-VH or equivalent

| Pin No. | Assignment | Mating Housing | Terminal |
|---------|------------|-----------------------|--------------------------------|
| 1 | +V | JST VHR or equivalent | JST SVH-21T-P1.1 or equivalent |
| 2 | -V | | |

⚡ : Grounding required

Block Diagram

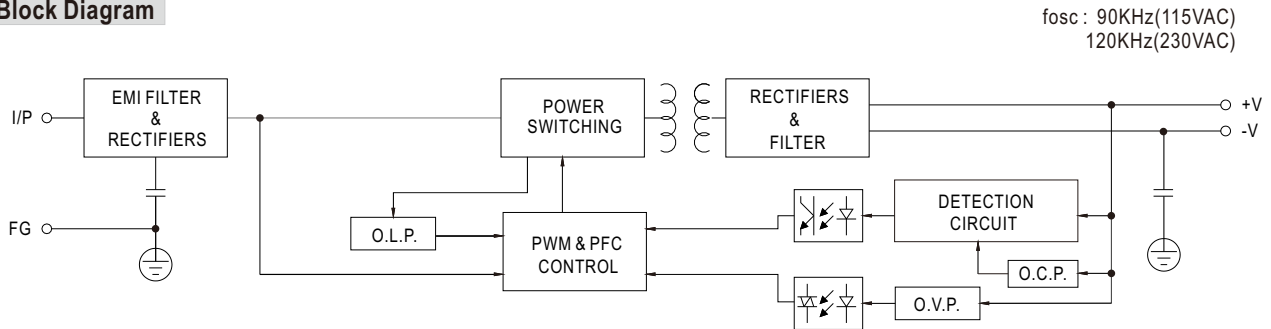

Derating Curve

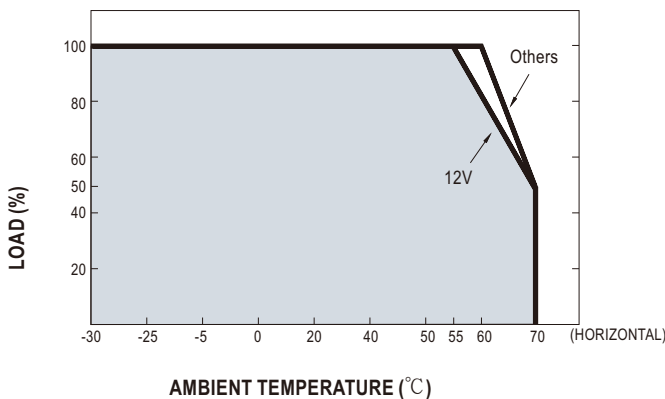

Static Characteristics

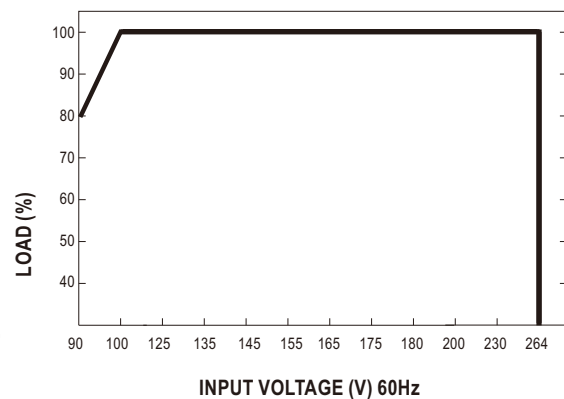

Power Factor Characteristic

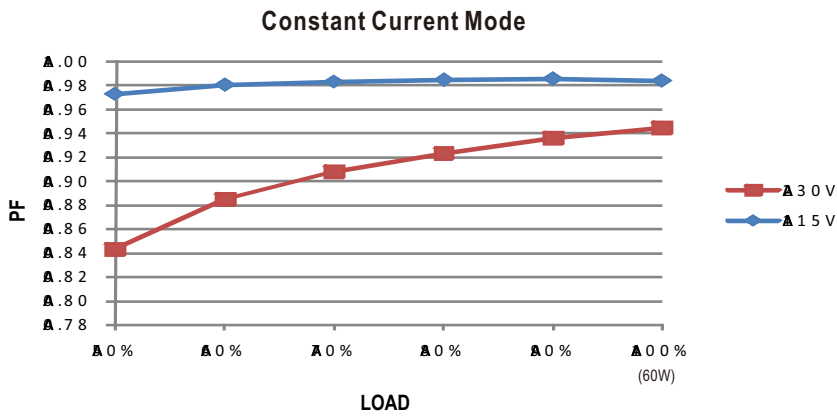

EFFICIENCY vs LOAD (48V Model)

PLP-60 series possess superior working efficiency that up to 89% can be reached in field applications.

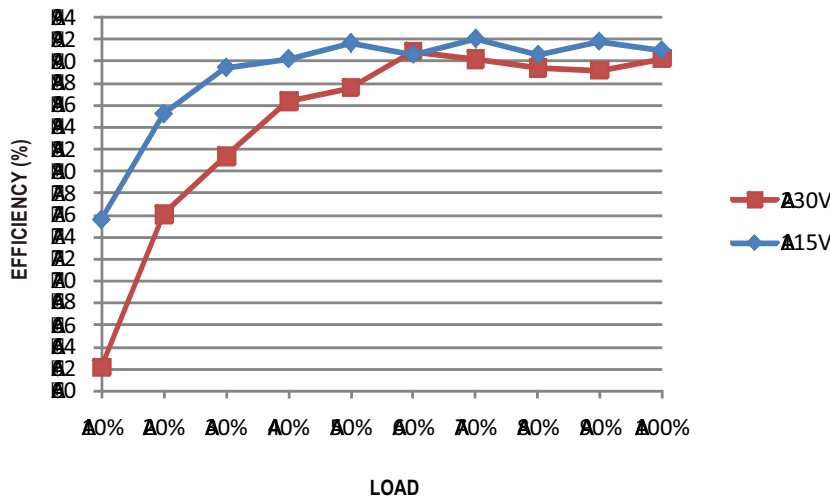

DRIVING METHODS OF LED MODULE

This LED power supply is suggested to work in constant current mode area (CC) to drive the LEDs.

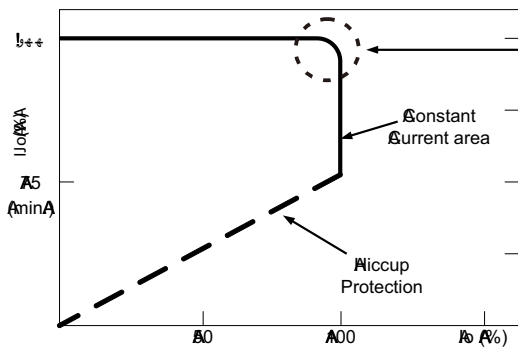

Typical LED power supply I-V curve

In the constant current region, the highest voltage at the output of the driver depends on the configuration of the end systems. Should there be any compatibility issues, please contact MEAN WELL.