

# FS2KM-12A

HIGH-SPEED SWITCHING USE

**FS2KM-12A**



- 10V DRIVE
- V<sub>DSS</sub> ..... 600V
- r<sub>DS (ON)</sub> (MAX) ..... 6.4Ω
- I<sub>D</sub> ..... 2A

**OUTLINE DRAWING** Dimensions in mm

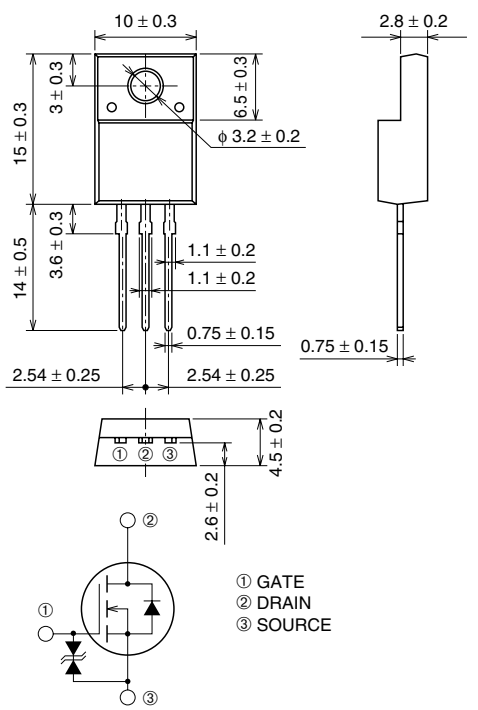

**TO-220FN**

## APPLICATION

SMPS, AC-adapter, Power supply of Printer, Copier, TV, VCR. etc.

### MAXIMUM RATINGS (T<sub>c</sub> = 25°C)

Symbol	Parameter	Conditions	Ratings	Unit
V <sub>DSS</sub>	Drain-source voltage	V <sub>GS</sub> = 0V	600	V
V <sub>GSS</sub>	Gate-source voltage	V <sub>DS</sub> = 0V	±30	V
I <sub>D</sub>	Drain current		2	A
I <sub>DM</sub>	Drain current (Pulsed)		6	A
I <sub>DA</sub>	Avalanche current (Pulsed)	L = 200μH	2	A
P <sub>D</sub>	Maximum power dissipation		25	W
T <sub>ch</sub>	Channel temperature		-55 ~ +150	°C
T <sub>stg</sub>	Storage temperature		-55 ~ +150	°C
V <sub>iso</sub>	Isolation voltage	AC for 1minute, Terminal to case	2000	V
—	Weight	Typical value	2.0	g

# FS2KM-12A

HIGH-SPEED SWITCHING USE

## ELECTRICAL CHARACTERISTICS (T<sub>ch</sub> = 25°C)

Symbol	Parameter	Test conditions	Limits			Unit
			Min.	Typ.	Max.	
V (BR) DSS	Drain-source breakdown voltage	I <sub>D</sub> = 1mA, V <sub>GS</sub> = 0V	600	—	—	V
V (BR) GSS	Gate-source breakdown voltage	I <sub>GS</sub> = ±100μA, V <sub>DS</sub> = 0V	±30	—	—	V
I <sub>GSS</sub>	Gate-source leakage current	V <sub>GS</sub> = ±25V, V <sub>DS</sub> = 0V	—	—	±10	μA
I <sub>DSS</sub>	Drain-source leakage current	V <sub>DS</sub> = 600V, V <sub>GS</sub> = 0V	—	—	1	mA
V <sub>GS</sub> (th)	Gate-source threshold voltage	I <sub>D</sub> = 1mA, V <sub>DS</sub> = 10V	2.5	3.0	3.5	V
r <sub>DS</sub> (ON)	Drain-source on-state resistance	I <sub>D</sub> = 1A, V <sub>GS</sub> = 10V	—	5.0	6.4	Ω
V <sub>DS</sub> (ON)	Drain-source on-state voltage	I <sub>D</sub> = 1A, V <sub>GS</sub> = 10V	—	5.0	6.4	V
y <sub>fs</sub>	Forward transfer admittance	I <sub>D</sub> = 1A, V <sub>DS</sub> = 10V	1.2	2.0	—	S
C <sub>iss</sub>	Input capacitance	V <sub>DS</sub> = 25V, V <sub>GS</sub> = 0V, f = 1MHz	—	280	—	pF
C <sub>oss</sub>	Output capacitance		—	30	—	pF
C <sub>rss</sub>	Reverse transfer capacitance		—	7	—	pF
t <sub>d</sub> (on)	Turn-on delay time	V <sub>DD</sub> = 200V, I <sub>D</sub> = 1A, V <sub>GS</sub> = 10V, R <sub>GEN</sub> = R <sub>GS</sub> = 50Ω	—	10	—	ns
t <sub>r</sub>	Rise time		—	10	—	ns
t <sub>d</sub> (off)	Turn-off delay time		—	45	—	ns
t <sub>f</sub>	Fall time		—	25	—	ns
V <sub>SD</sub>	Source-drain voltage	I <sub>S</sub> = 1A, V <sub>GS</sub> = 0V	—	1.5	2.0	V
R <sub>th</sub> (ch-c)	Thermal resistance	Channel to case	—	—	5.00	°C/W

## PERFORMANCE CURVES

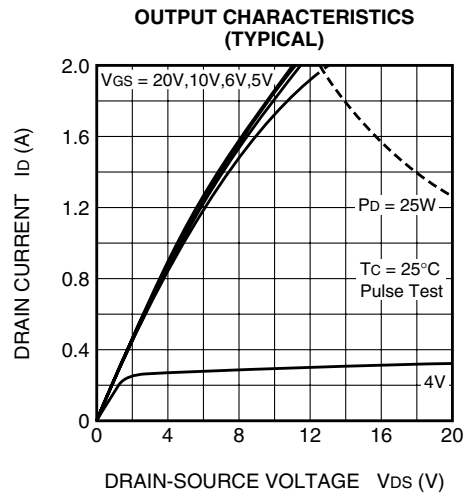
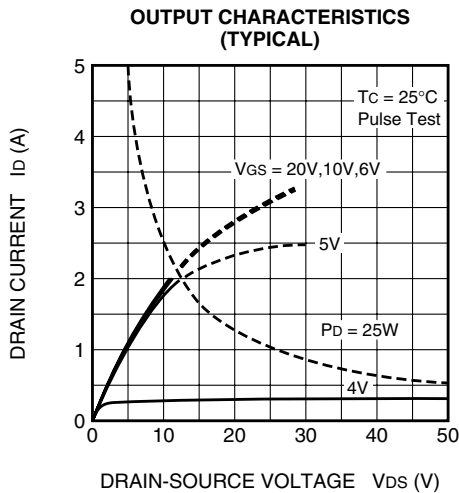
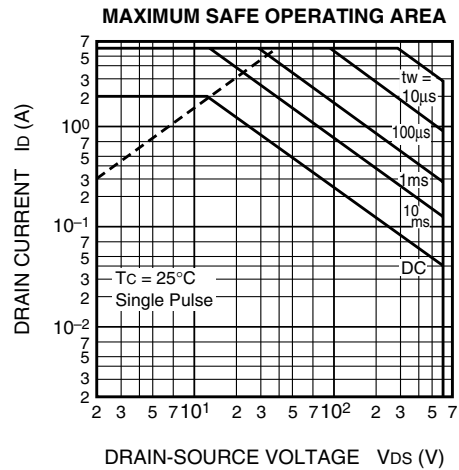
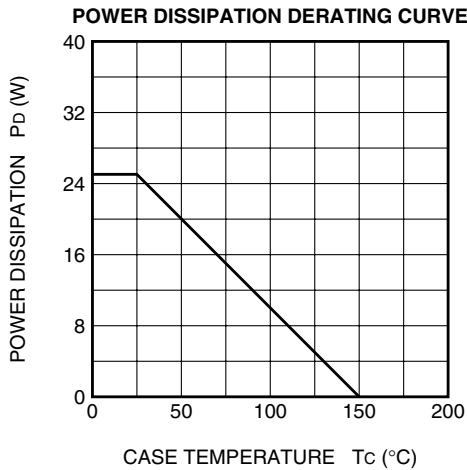

# FS2KM-12A

HIGH-SPEED SWITCHING USE

**ON-STATE VOLTAGE VS. GATE-SOURCE VOLTAGE (TYPICAL)**

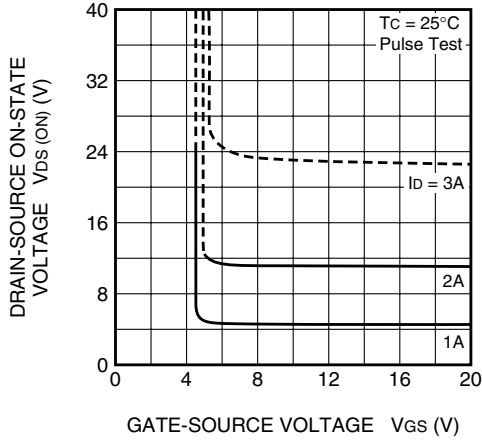

**ON-STATE RESISTANCE VS. DRAIN CURRENT (TYPICAL)**

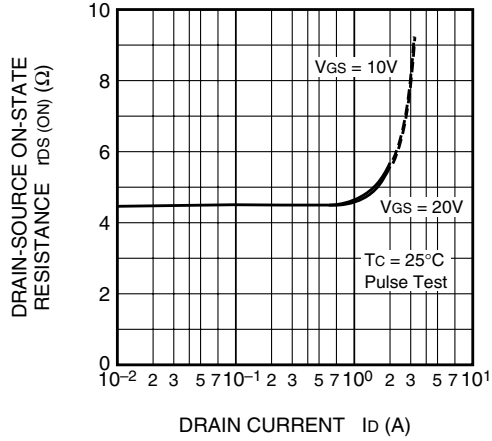

**TRANSFER CHARACTERISTICS (TYPICAL)**

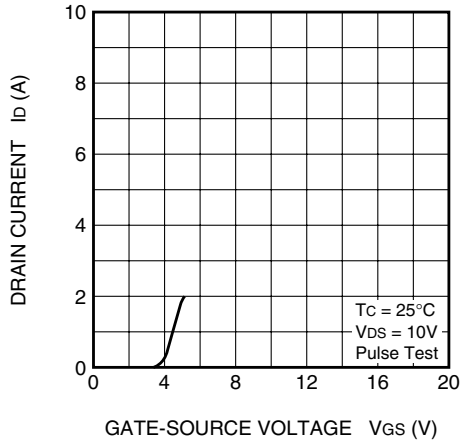

**FORWARD TRANSFER ADMITTANCE VS. DRAIN CURRENT (TYPICAL)**

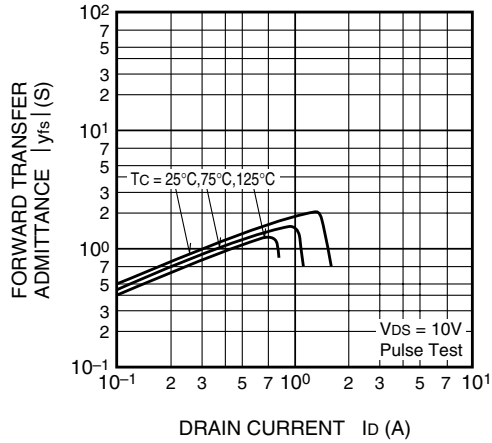

**CAPACITANCE VS. DRAIN-SOURCE VOLTAGE (TYPICAL)**

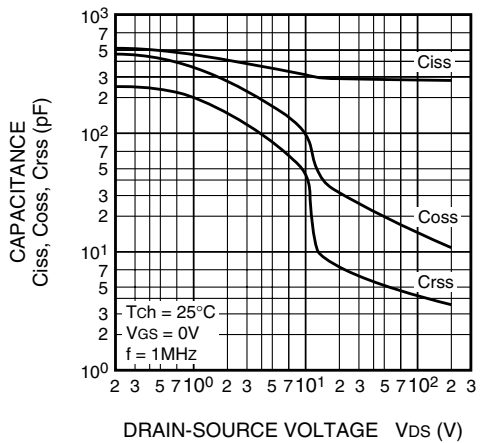

**SWITCHING CHARACTERISTICS (TYPICAL)**

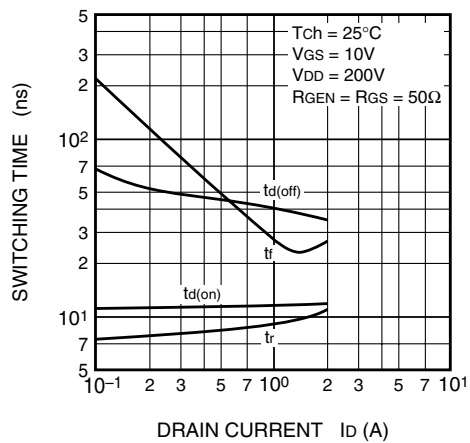

# FS2KM-12A

HIGH-SPEED SWITCHING USE

**GATE-SOURCE VOLTAGE VS. GATE CHARGE (TYPICAL)**

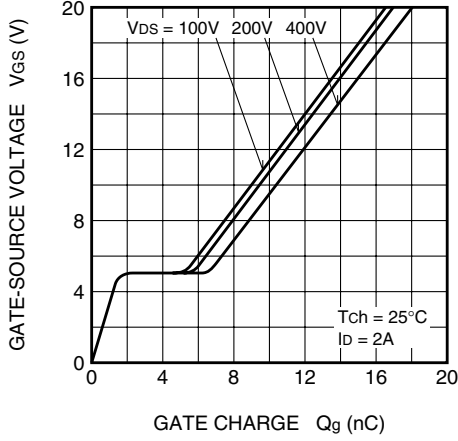

**SOURCE-DRAIN DIODE FORWARD CHARACTERISTICS (TYPICAL)**

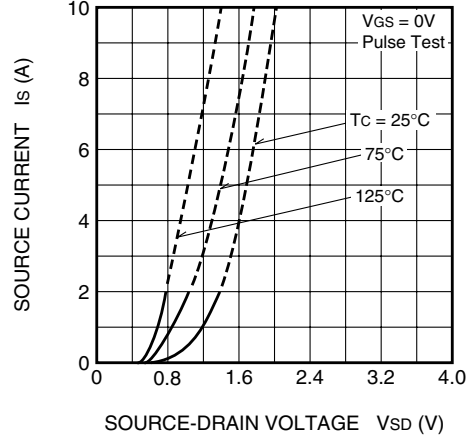

**ON-STATE RESISTANCE VS. CHANNEL TEMPERATURE (TYPICAL)**

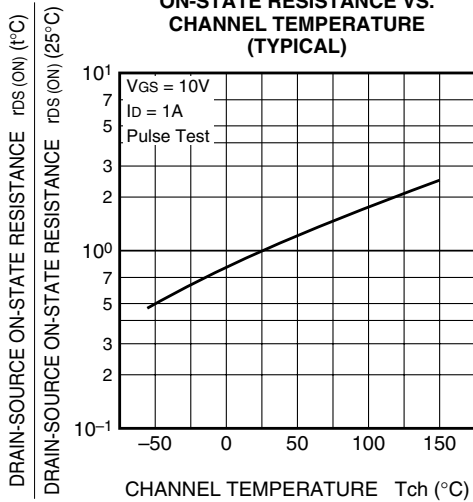

**THRESHOLD VOLTAGE VS. CHANNEL TEMPERATURE (TYPICAL)**

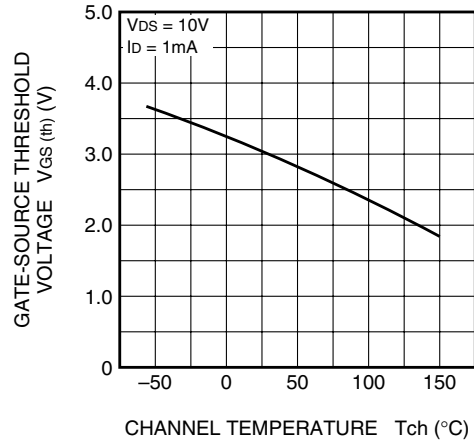

**BREAKDOWN VOLTAGE VS. CHANNEL TEMPERATURE (TYPICAL)**

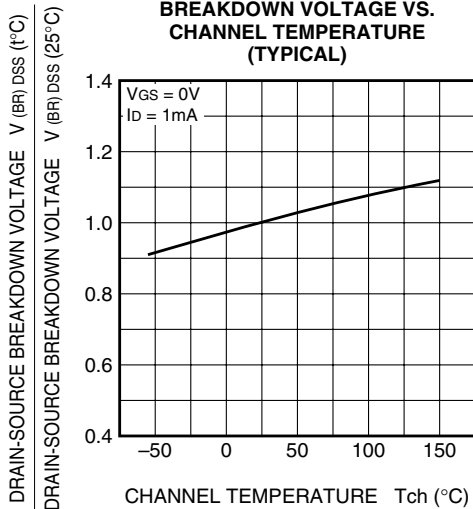

**TRANSIENT THERMAL IMPEDANCE CHARACTERISTICS**

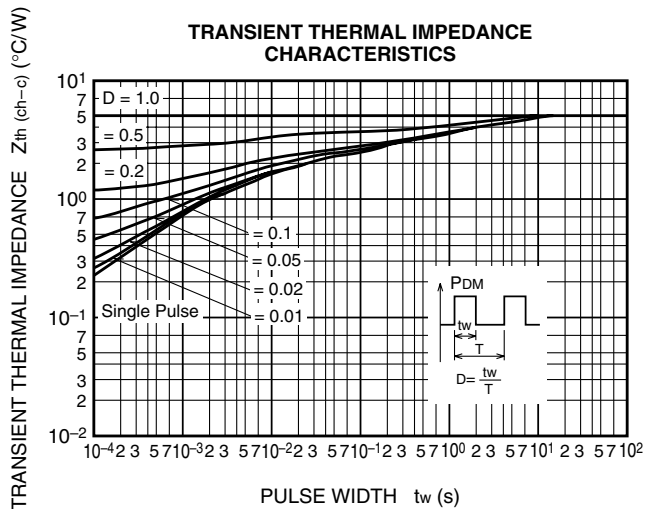

This datasheet has been download from:

[www.datasheetcatalog.com](http://www.datasheetcatalog.com)

Datasheets for electronics components.