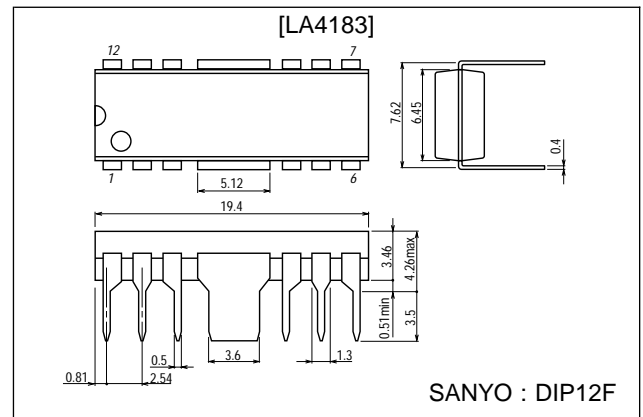

SANYO**LA4183****2.3 W 2-Channel AF Power Amplifier for Radio Cassette Players****Features**

- Built-in 2 channels enabling use in stereo and bridge amplifier (BTL) applications.
- High-output:
2.3 W typ./channel, $V_{CC} = 9\text{ V}$, $R_L = 4\ \Omega$
4.7 W typ./bridge amplifier, $V_{CC} = 9\text{ V}$, $R_L = 8\ \Omega$
- Low switching distortion at high frequencies.
- Minimum number of external parts required: 9 pcs. min. (Stereo/bridge).
- Small shock noise at the time of power supply ON/OFF due to built-in muting circuit.
- Good ripple rejection due to built-in ripple filter.
- Soft tone at the time of output saturation.
- Good channel separation.
- Voltage gain fixed at 45 dB (Bridge: 51 dB).
Variable voltage gain available with external resistor added.

Package Dimensions

unit : mm

3022A-DIP12F**Note:**

In general applications, heat generated in the DIP 12-pin package can be radiated through the Cu-foiled area of the printed circuit board, but since power dissipation P_d may be increased depending on the supply voltage and load conditions, it is recommended to use a fin additionally.

Specifications**Maximum Ratings at $T_a = 25^\circ\text{C}$**

Parameter	Symbol	Conditions	Ratings	Unit
Maximum supply voltage	$V_{CC\text{ max}}$	With signal	11	V
		Quiescent	15	V
Allowable power dissipation	$P_d\text{ max}$	With printed circuit board (Refer to $P_d - T_a$ characteristics)	4	W
Operating temperature	T_{opr}		-20 to +75	$^\circ\text{C}$
Storage temperature	T_{stg}		-55 to +150	$^\circ\text{C}$

Operating Conditions at $T_a = 25^\circ\text{C}$

Parameter	Symbol	Conditions	Ratings	Unit
Recommended supply voltage	V_{CC}		9.0	V
Load resistance	R_L	Stereo	4.0 to 8.0	Ω
		Bridge	8.0	Ω

■ Any and all SANYO products described or contained herein do not have specifications that can handle applications that require extremely high levels of reliability, such as life-support systems, aircraft's control systems, or other applications whose failure can be reasonably expected to result in serious physical and/or material damage. Consult with your SANYO representative nearest you before using any SANYO products described or contained herein in such applications.

■ SANYO assumes no responsibility for equipment failures that result from using products at values that exceed, even momentarily, rated values (such as maximum ratings, operating condition ranges, or other parameters) listed in products specifications of any and all SANYO products described or contained herein.

SANYO Electric Co.,Ltd. Semiconductor Company

TOKYO OFFICE Tokyo Bldg., 1-10, 1 Chome, Ueno, Taito-ku, TOKYO, 110-8534 JAPAN

53096HA(II)/O0207TA/2022KI,TS,ID No.887-1/12

LA4183

**Operating Characteristics at $T_a = 25^\circ\text{C}$, $V_{CC} = 9.0\text{ V}$, $f = 1\text{ kHz}$, $R_g = 600\ \Omega$, $R_L = 4\ \Omega$, (): $8\ \Omega$,
See specified Test Circuit.**

Parameter	Symbol	Conditions	min	typ	max	Unit	
Quiescent current	I_{CCO}	For stereo		40	55	mA	
Voltage gain	VG	Closed loop, $V_{IN} = -45\text{ dB}$	Stereo	43	45	47	dB
			Bridge	49	51	53	dB
Voltage gain difference	ΔVG				± 1	dB	
Output power	P_O	THD = 10%	Stereo	1.7	2.3		W
			Bridge		(1.3)		W
Total harmonic distortion	THD	$P_O = 250\text{ mW}$	Stereo		0.3	1.5	%
			Bridge		0.5		%
Input resistance	r_i		21	30		k Ω	
Output noise voltage	V_{NO}	$R_g = 0$	Stereo		0.3	1.0	mV
		$R_g = 10\text{ k}\Omega$	Stereo		0.5	2.0	mV
Ripple rejection ratio	—	$R_g = 0$, $V_r = 150\text{ mV}$	Stereo	40	46		dB
Channel separation	CHsep	$R_g = 10\text{ k}\Omega$, $V_O = 0\text{ dBm}$	Stereo	40	55		dB

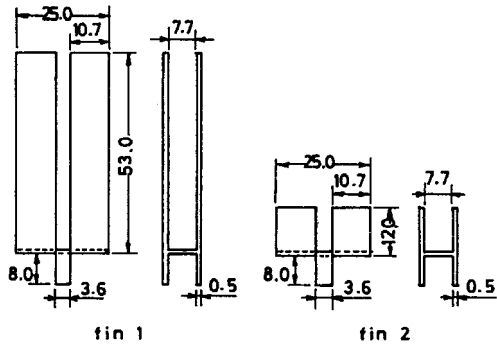
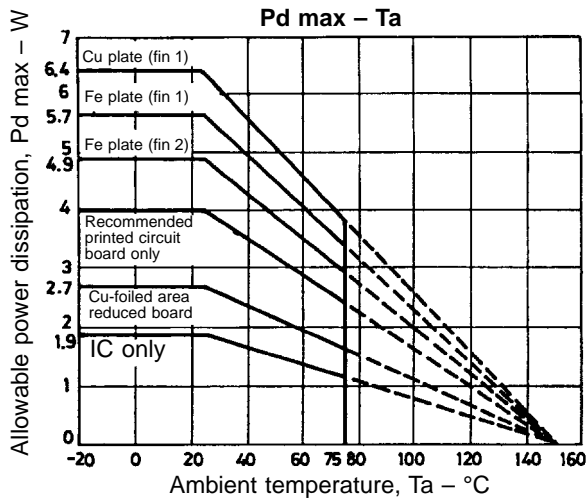

Pin Assignment and Equivalent Circuit

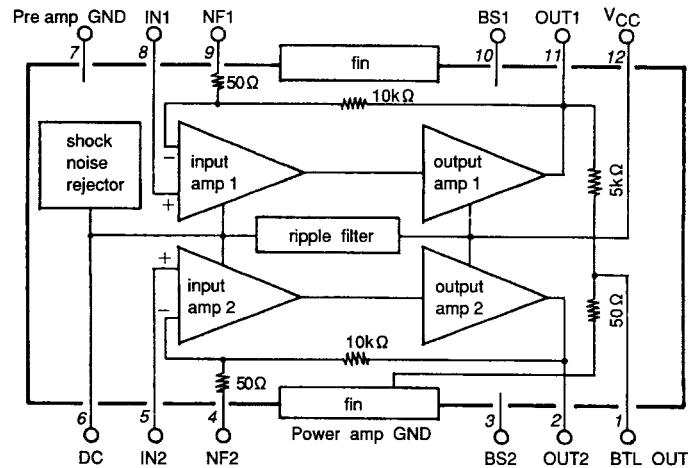

LA4183

Sample Application Circuit 1: Stereo amplifier

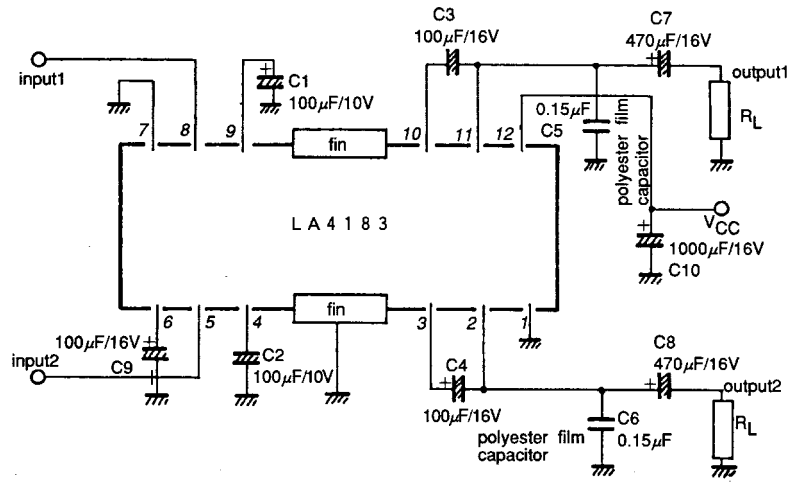

Sample Application Circuit 2: Bridge amplifier

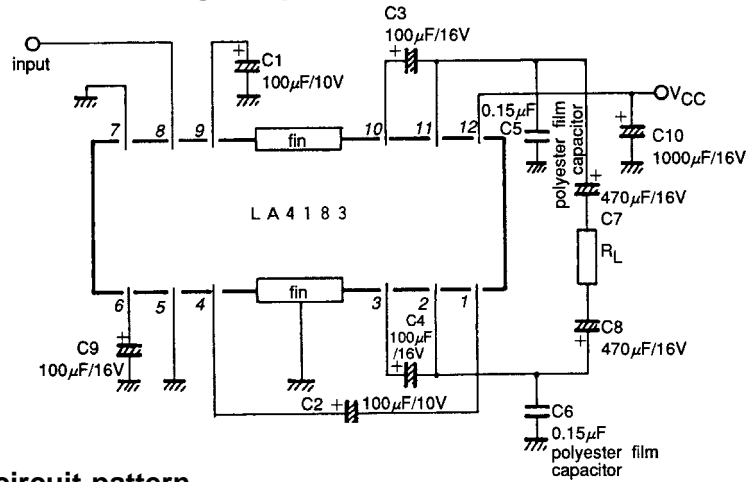

Example of printed circuit pattern (Cu-foiled area) for use in stereo, bridge amplifier applications

60 × 80 mm²

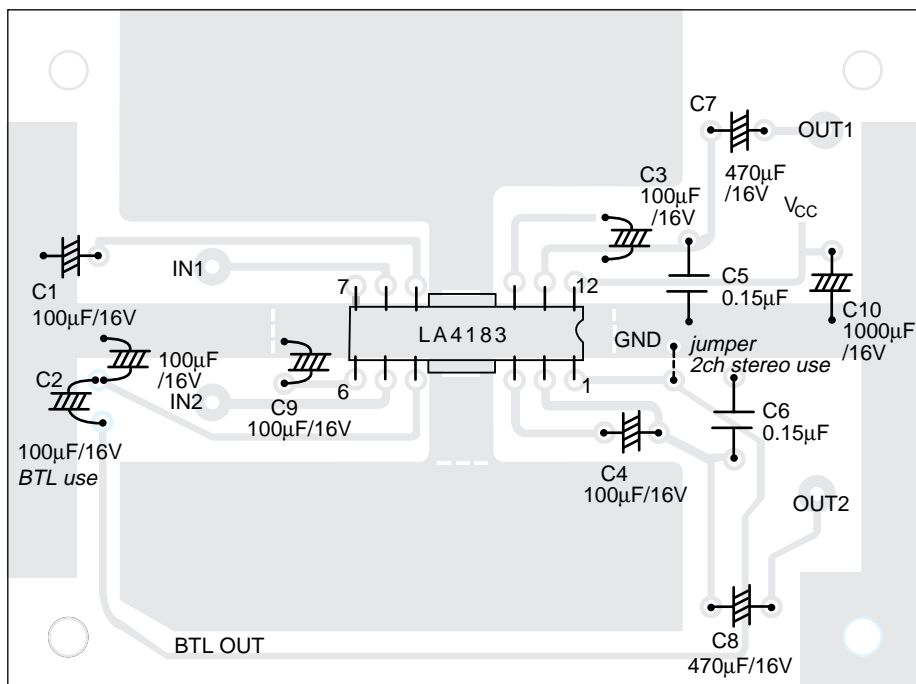

Description of External Parts

C1 (C2)	Feedback capacitor	The low-range cut-off frequency is determined by the following formula: $f_L = 1 / (2 \pi C1 \cdot Rf)$, f_L : Low-range cut-off frequency Rf: Feedback resistor (50 Ω embedded + Rf externally connected) The frequency, however, affects the starting time in conjunction with decoupling capacitors. Therefore, it is necessary to determine it after a full review of the required low-frequency range and other similar conditions.
C3 (C4)	Bootstrap capacitor	The output at low frequencies depends on this capacitor. If the capacity is decreased, the output at low frequencies goes lower. 47 μ F min. is required.
C5 (C6)	Oscillation preventing capacitor	Use polyester film capacitor which is good in temperature characteristic and frequency characteristic. Aluminum electrolytic capacitor or ceramic capacitor causes oscillation at low temperatures.
C7 (C8)	Output capacitor	The low-range cut-off frequency is determined by the following formula. $f_L = 1 / (2\pi C7 \cdot R_L)$, f_L : Low-range cut-off frequency R_L : Load resistance When using bridge-connected, double the capacitance to obtain equivalent low-range frequency characteristics to those in a 2-channel application.
C9	Decoupling capacitor	Used for the ripple filter. Since the rejection effect is saturated at a certain capacity, it is meaningless to increase the capacity more than needed. This capacitor, being also used for the time constant of the muting circuit, affects the starting time.
C10	Power source capacitor	

Application Circuits

1. Voltage gain adjustment

• Stereo

The voltage gain depends on built-in-resistors R1 (R2), R3 (R4) as follows:

$$VG = 20 \log \frac{R3 (R4)}{R1 (R2)} \text{ [dB]}$$

If the IC is used at a voltage gain less than this, the following equation with Rf added applies.

$$VG = 20 \log \frac{R3 (R4)}{R1 (R2) + Rf} \text{ [dB]}$$

where R1 (R2) = 50 Ω typ.,

R3 (R4) = 10 k Ω typ.

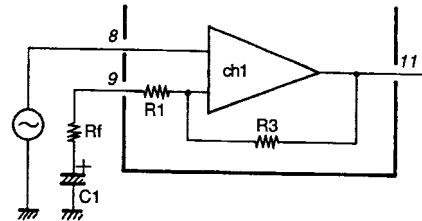

• Bridge

The following shows the bridge amplifier configuration, where ch1 operates as a non-inverting amplifier and ch2 as an inverting amplifier.

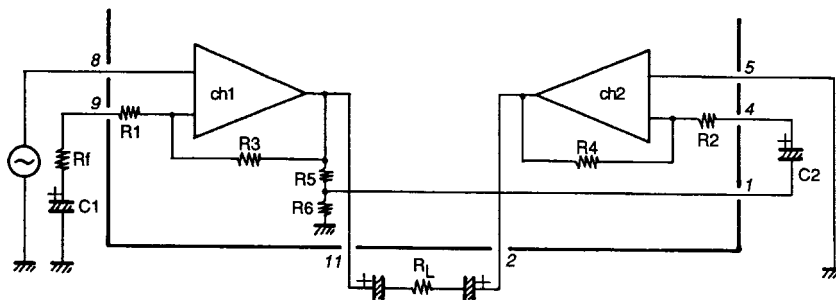

LA4183

The output of ch1 is divided with R5, R6 and led to pin 1 and then inputted to ch2. Since the attenuation degree (R5/R6) of ch1 output and the amplification degree (R4/R2 + R6)) of ch2 are fixed at an equal value, the ch2 output is in opposite phase with the ch1 output. Therefore, the total voltage gain gets apparently 6 dB higher than the voltage gain of ch1 alone and is determined by the following equation.

$$VG = 20 \log \frac{R3}{R1} + 6 \text{ [dB]}$$

If the IC is used at a voltage gain less than this, the following equation with Rf added applies.

$$VG = 20 \log \frac{R3}{R1 + Rf} + 6 \text{ [dB]}$$

2. Starting time

Starting time depends on capacitance of C1 (C2) and C9 as shown in the diagram below. That is because of using a muting circuit utilizing the C9 (decoupling capacitor) time constant for pop noise prevention when power is turned on and charging circuits for C1 and C2 (NF capacitors).

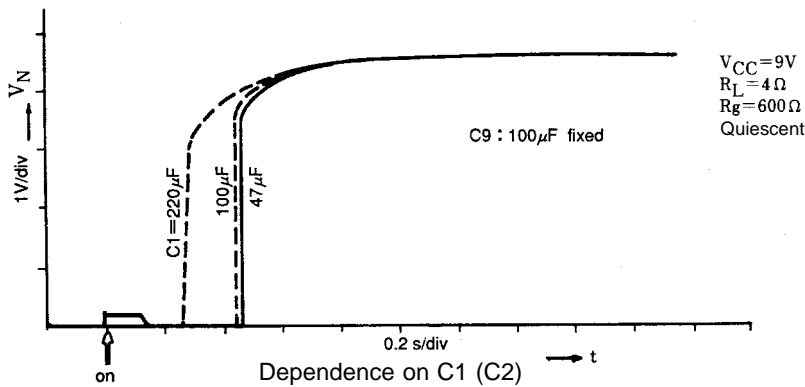
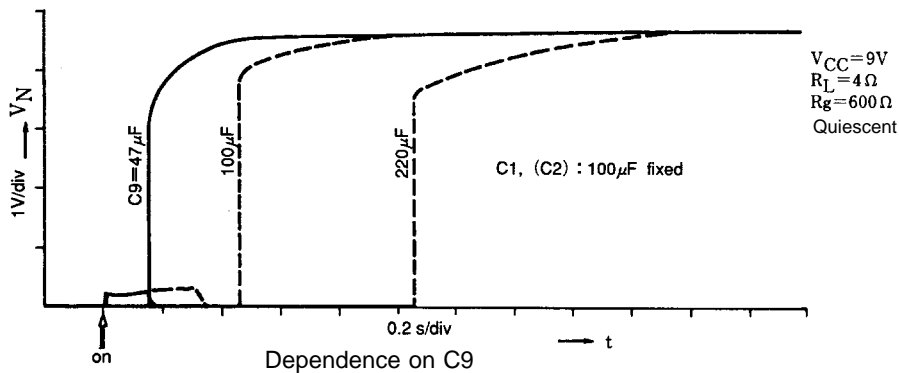

3. Crosstalk

Channel separation characteristic is important for single-package IC embodying two channels.

With LA4183, good channel separation is obtainable even as is, but if the BTL OUT pin (pin 1) is not grounded, it will invite imbalance in crosstalk between the two channels. (Refer to the characteristics diagram.)

Proper Cares in Operating a Set with LA4183 Incorporated

When a set with the LA4183 incorporated is operated from AC power supply, a momentary drop in supply voltage is caused by the transformer regulation, etc. at the time of turning ON the motor with the circuit shown below. In this case, if ripple noise is generated from the speaker or headphone, take the following actions.

1. Connect a diode (rectifier diode of average rectified current $I_O = 100$ to 200 mA) across pins 6 and 12 of the LA4183 so that the voltage at pin 6 can follow the supply voltage regulation. In the steady state, this diode is cut off.
2. Increase the capacity of the power source capacitor so that the supply voltage regulation can be minimized.

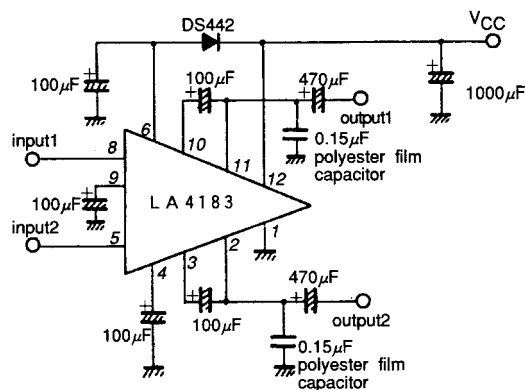
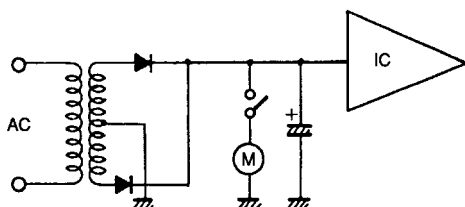

Radiation Design

- Since the DIP 12-pin package is so designed as to be able to radiate heat through the Cu-foiled area of printed circuit board under normal operating conditions, make the Cu-foiled area near the fin of IC as large as possible when designing the printed circuit board.
- By providing the Cu-foiled area covered by the broken line as shown in the above-mentioned example of printed circuit pattern, a rather satisfactory radiation is enabled. (Refer to the Pd – Ta characteristics.)
- Since the power dissipation (Pd) goes higher depending on the conditions of supply voltage and load, it is recommended to use the fin together with the printed circuit board.
- The following equations are rule-of-thumb guides for Pd (for stereo). For AC power supply, it is desirable to measure with the transformer of each individual set. In the bridge amplifier application, calculation should be made with 1/2 of the load used.

(1) DC Power supply

$$Pd \max = \frac{V_{CC}^2}{\pi^2 R_L} + I_{CCO} \cdot V_{CC} \text{ (For stereo)}$$

(2) AC power supply

$$Pd \max = \frac{V_{CC} (Pd)^2}{\pi^2 R_L} + I_{CCO} \cdot V_{CC} (Pd) \text{ (For stereo)}$$

V_{CC2} : Quiescent supply voltage

I_{CCO} : Quiescent current

$V_{CC} (Pd)$: Supply voltage at Pd max. output,

$$V_{CC} (Pd) = \frac{(1 + r) V_{CC1}}{1 + \frac{r \cdot V_{CC1}}{\sqrt{2} \cdot \pi \cdot R_L} \times \sqrt{\frac{R_L}{P_{O \max}}}}$$

V_{CC1} : Supply voltage at max. output

r: Voltage regulation, $\frac{V_{CC2} - V_{CC1}}{V_{CC1}}$

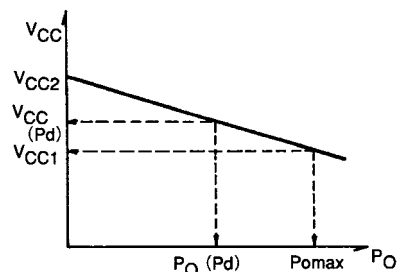

• Example of fin mounting

The fin is formed into such a shape as to be able to radiate heat from the plastic area of IC and the fin as shown below and is soldered to the printed circuit board. For the fin size, refer to the Pd – Ta characteristics. The desirable material is copper or iron which is solderable. It is recommended to apply silicone grease, etc. to the plastic area of IC in order to minimize the thermal resistance.

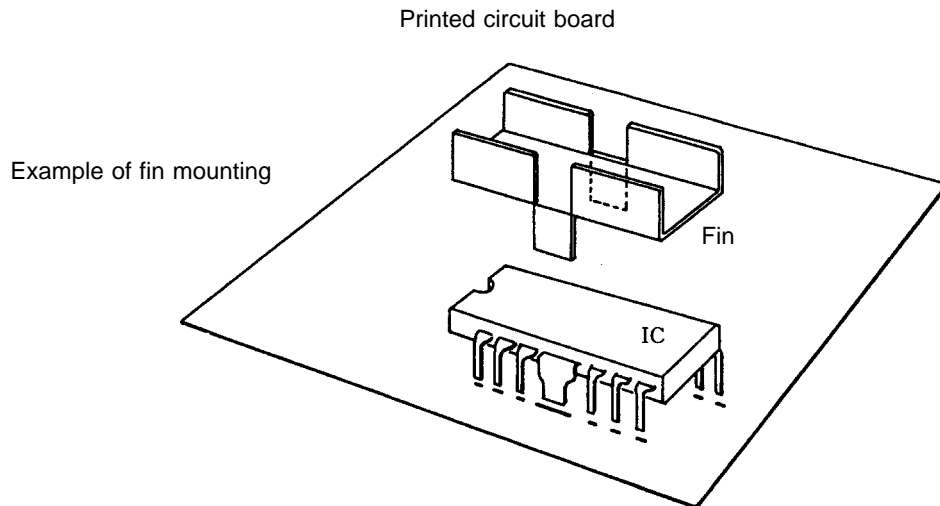

IC Usage Notes

1. If the IC is used in the vicinity of the maximum rating, even a slight variation in conditions may cause the maximum rating to be exceeded, thereby leading to a breakdown. Allow an ample margin of variation for supply voltage, etc. and use the IC in the range where the maximum rating is not exceeded.
2. Pin-to-pin short
If the supply voltage is applied when the space between pins is shorted, a breakdown or deterioration may occur. When installing the IC on the board or applying the supply voltage, make sure that the space between pins is not shorted with solder, etc.
3. Load short
If the IC is used with the load shorted for a long time, a breakdown or deterioration will occur. Be sure not to short the load.
4. When the IC is used in radios or radio cassette tape recorders, keep a good distance between IC and bar antenna.
5. When making the board, refer to the example of printed circuit pattern.

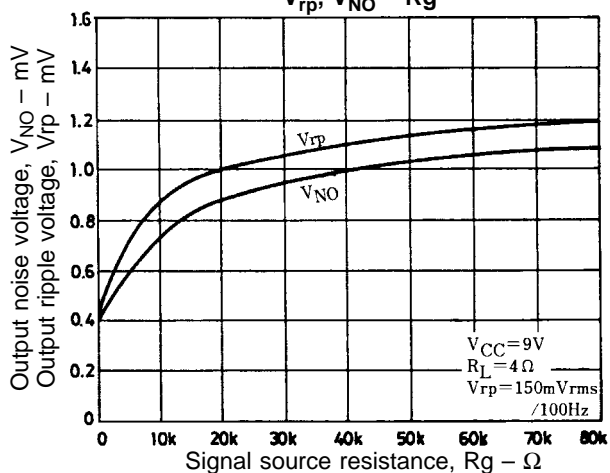
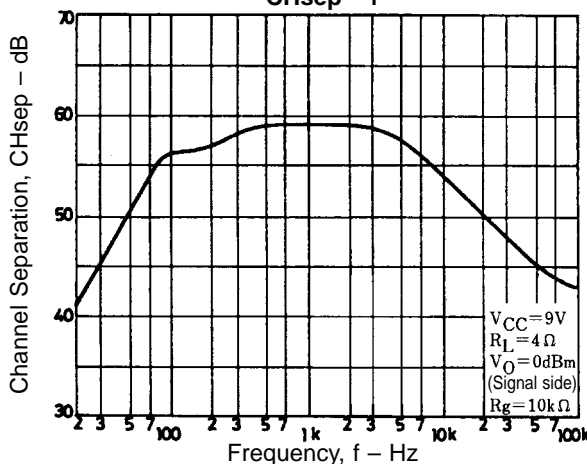
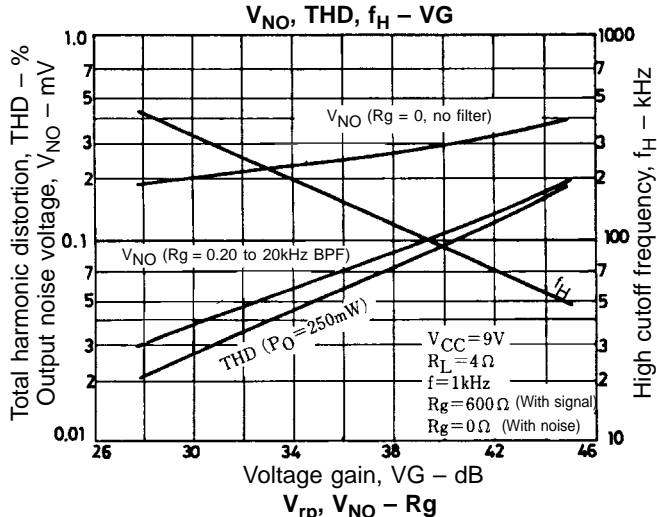
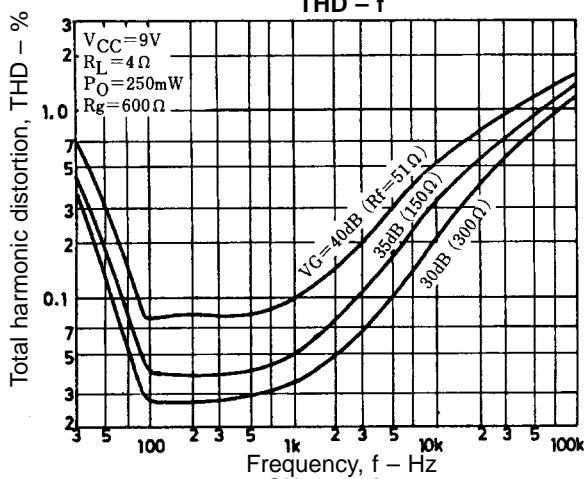
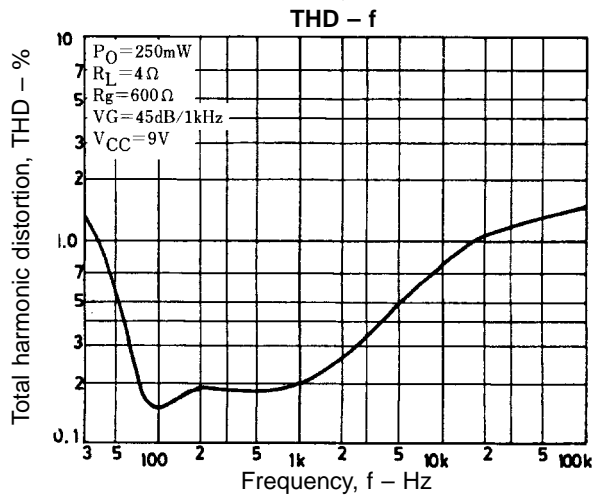
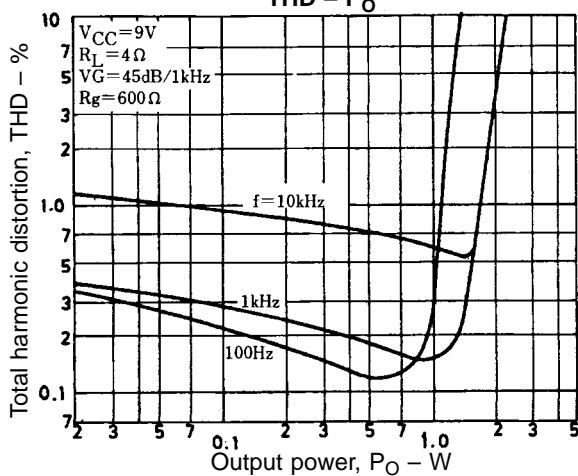
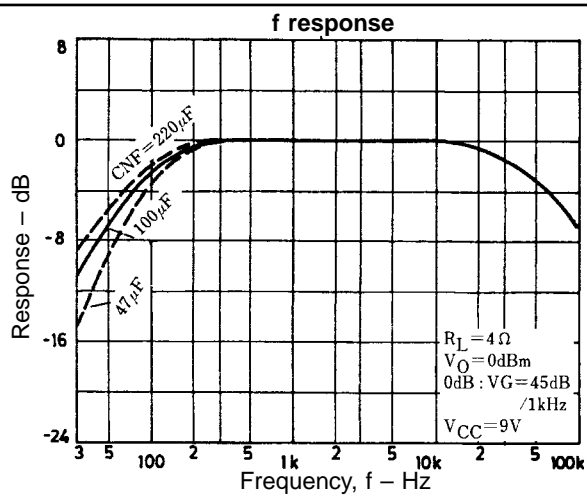
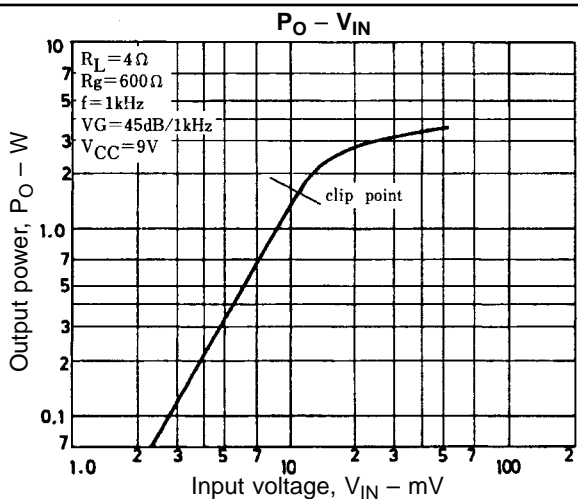

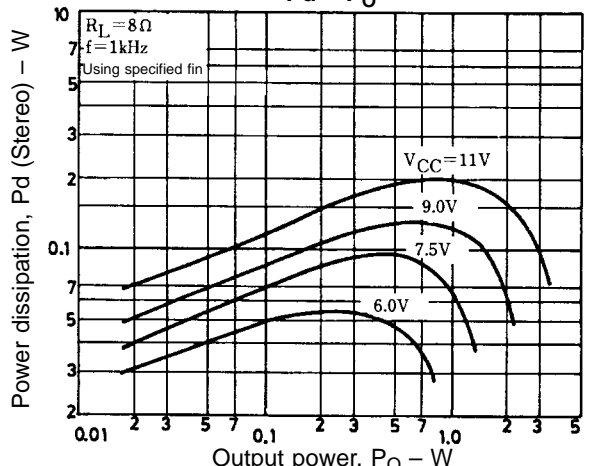
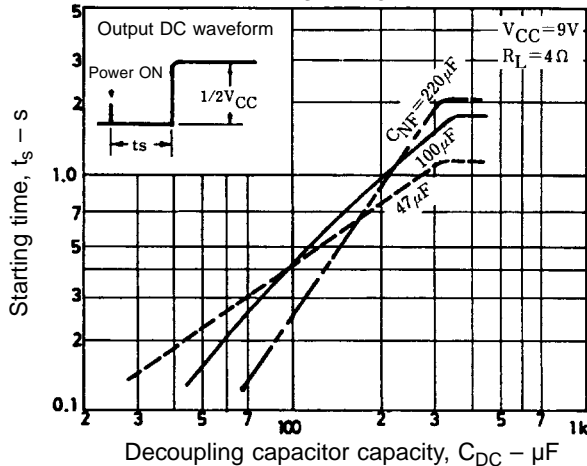
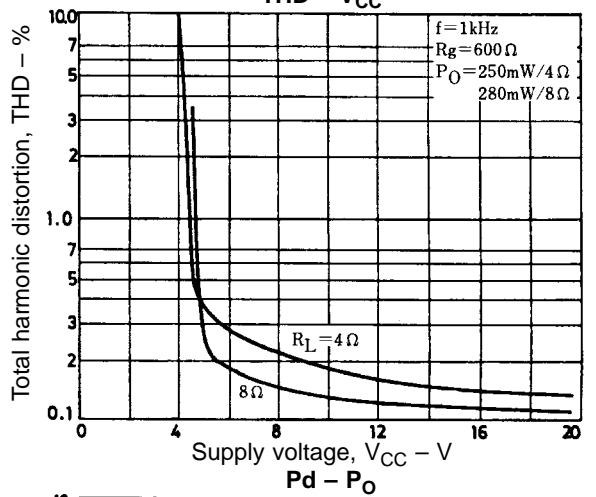
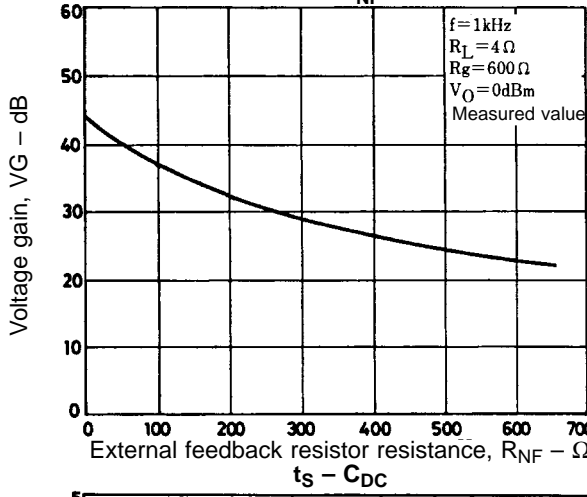
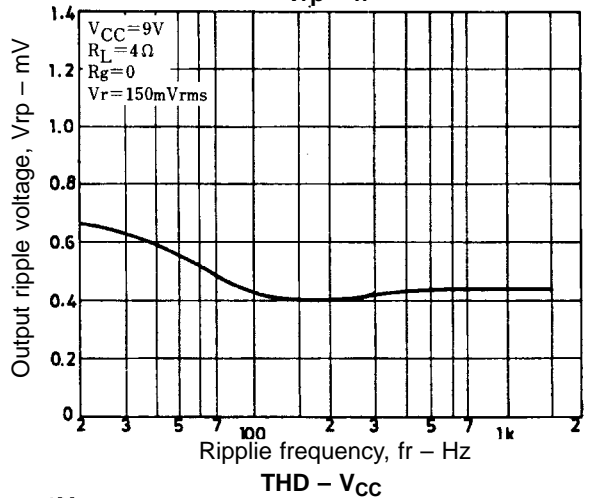
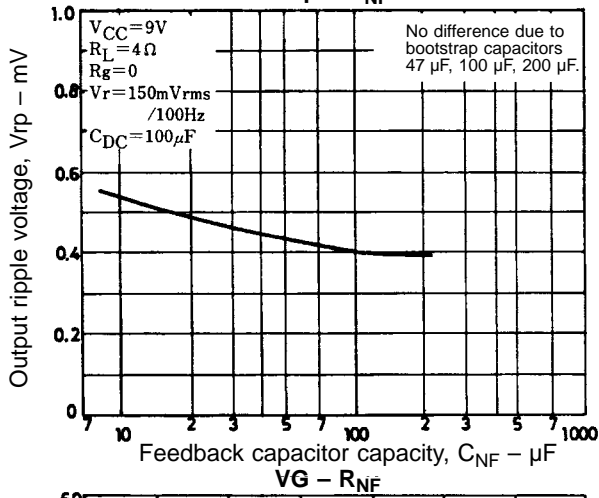
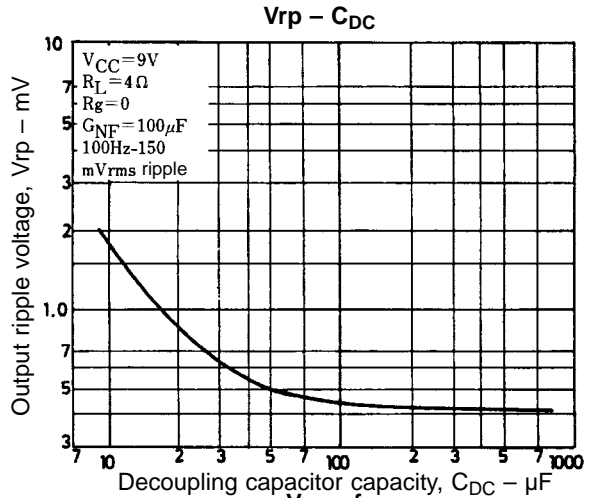
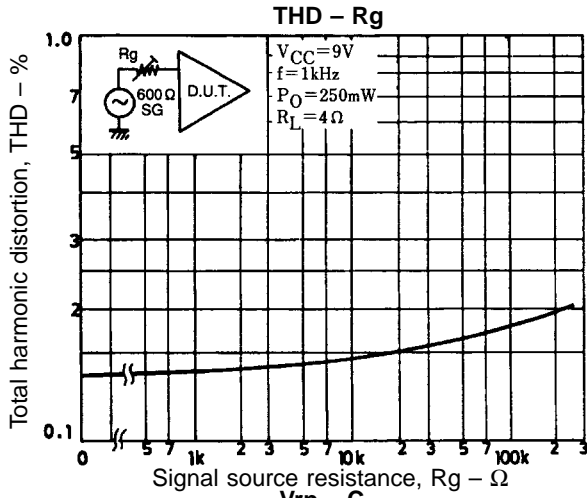

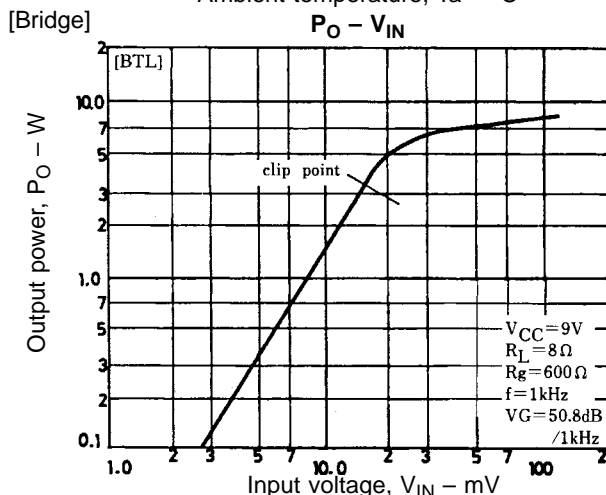
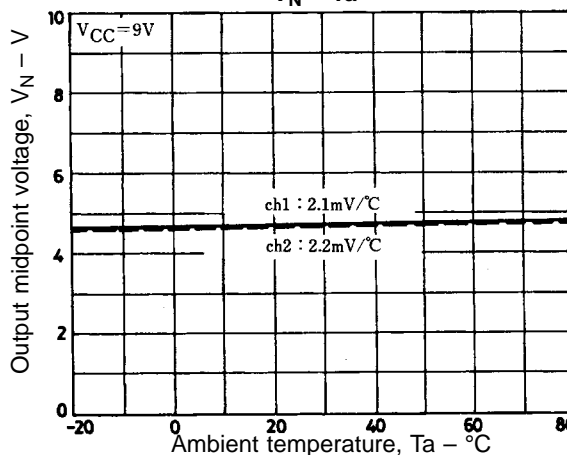
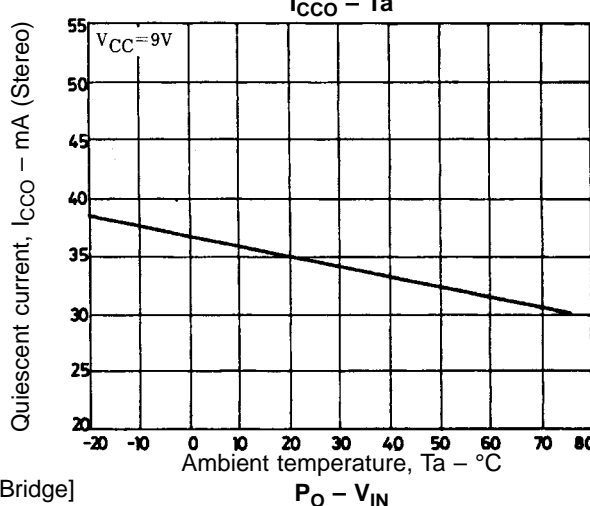
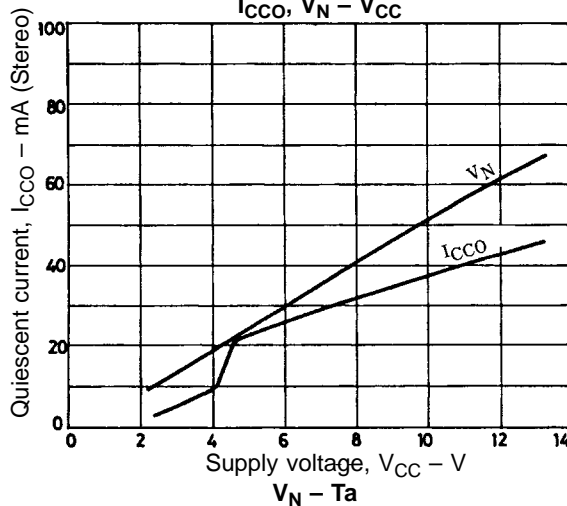
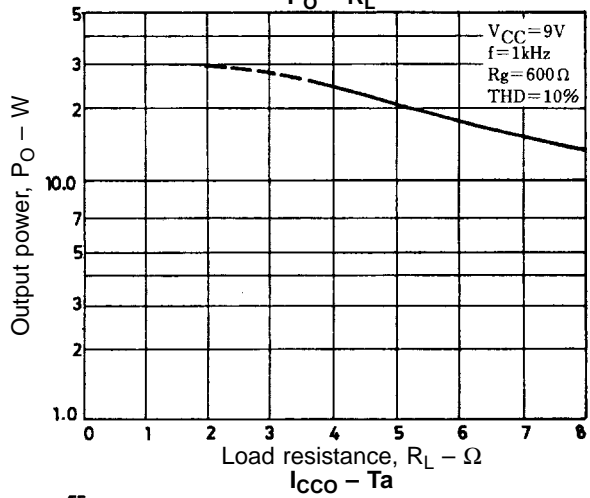
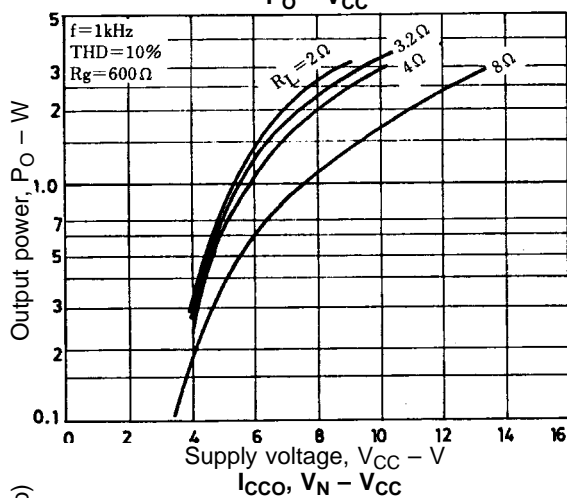
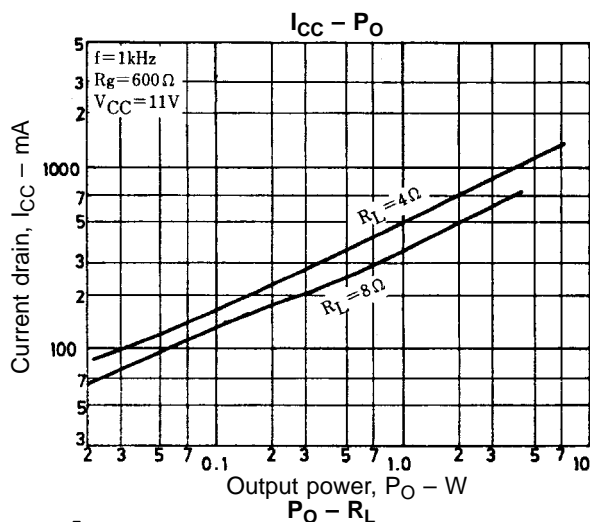
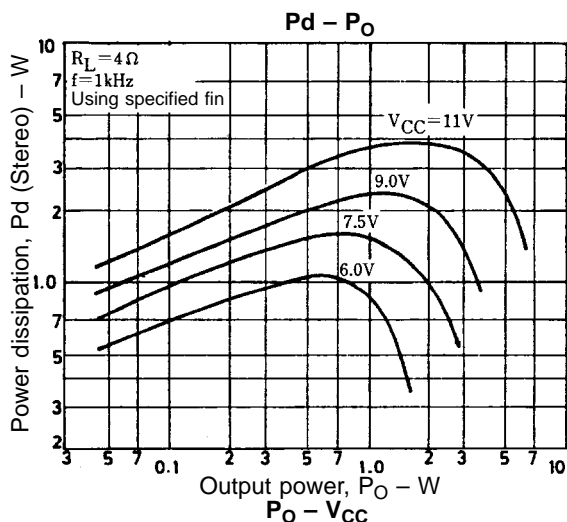

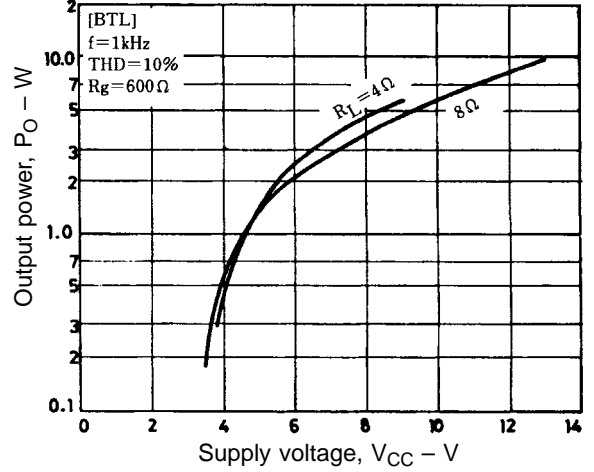
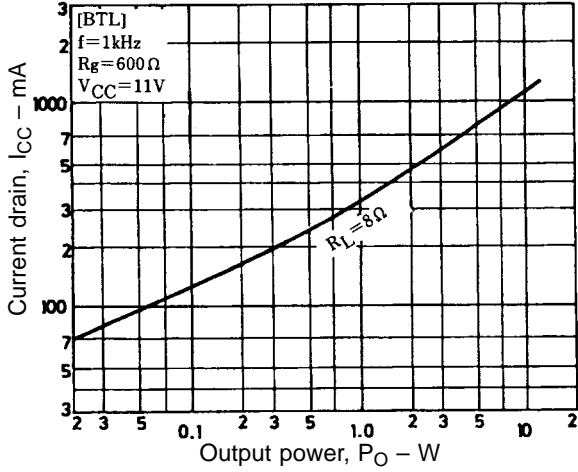
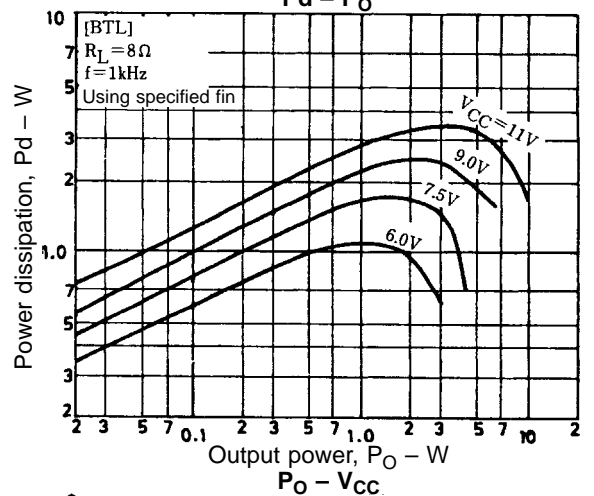
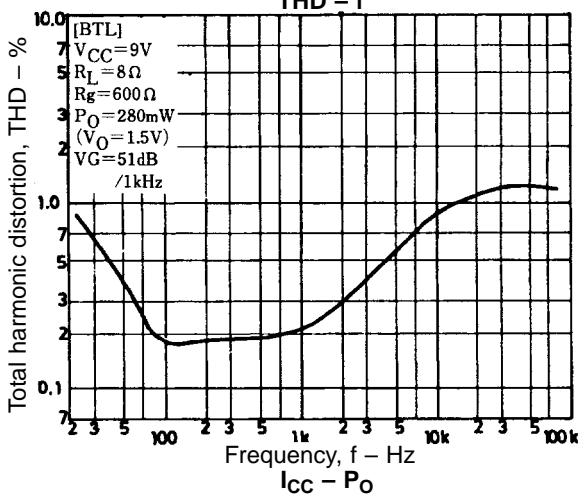
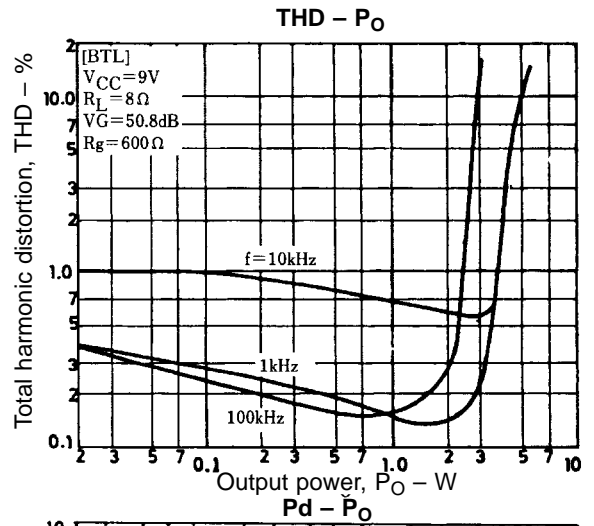
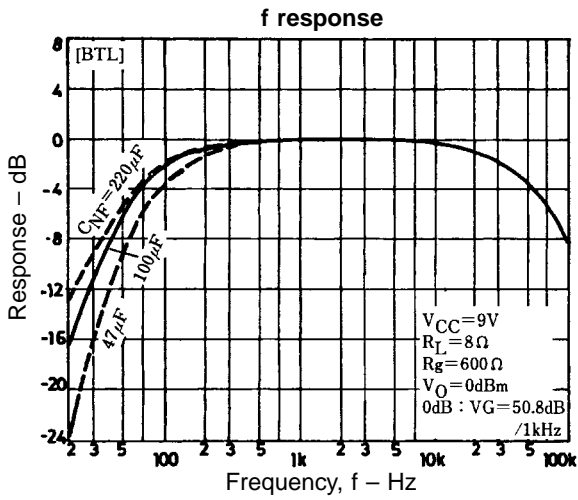

- Specifications of any and all SANYO products described or contained herein stipulate the performance, characteristics, and functions of the described products in the independent state, and are not guarantees of the performance, characteristics, and functions of the described products as mounted in the customer's products or equipment. To verify symptoms and states that cannot be evaluated in an independent device, the customer should always evaluate and test devices mounted in the customer's products or equipment.
- SANYO Electric Co., Ltd. strives to supply high-quality high-reliability products. However, any and all semiconductor products fail with some probability. It is possible that these probabilistic failures could give rise to accidents or events that could endanger human lives, that could give rise to smoke or fire, or that could cause damage to other property. When designing equipment, adopt safety measures so that these kinds of accidents or events cannot occur. Such measures include but are not limited to protective circuits and error prevention circuits for safe design, redundant design, and structural design.
- In the event that any or all SANYO products(including technical data, services) described or contained herein are controlled under any of applicable local export control laws and regulations, such products must not be exported without obtaining the export license from the authorities concerned in accordance with the above law.
- No part of this publication may be reproduced or transmitted in any form or by any means, electronic or mechanical, including photocopying and recording, or any information storage or retrieval system, or otherwise, without the prior written permission of SANYO Electric Co., Ltd.
- Any and all information described or contained herein are subject to change without notice due to product/technology improvement, etc. When designing equipment, refer to the "Delivery Specification" for the SANYO product that you intend to use.
- Information (including circuit diagrams and circuit parameters) herein is for example only ; it is not guaranteed for volume production. SANYO believes information herein is accurate and reliable, but no guarantees are made or implied regarding its use or any infringements of intellectual property rights or other rights of third parties.

This catalog provides information as of May, 1996. Specifications and information herein are subject to change without notice.

This datasheet has been download from:

www.datasheetcatalog.com

Datasheets for electronics components.