

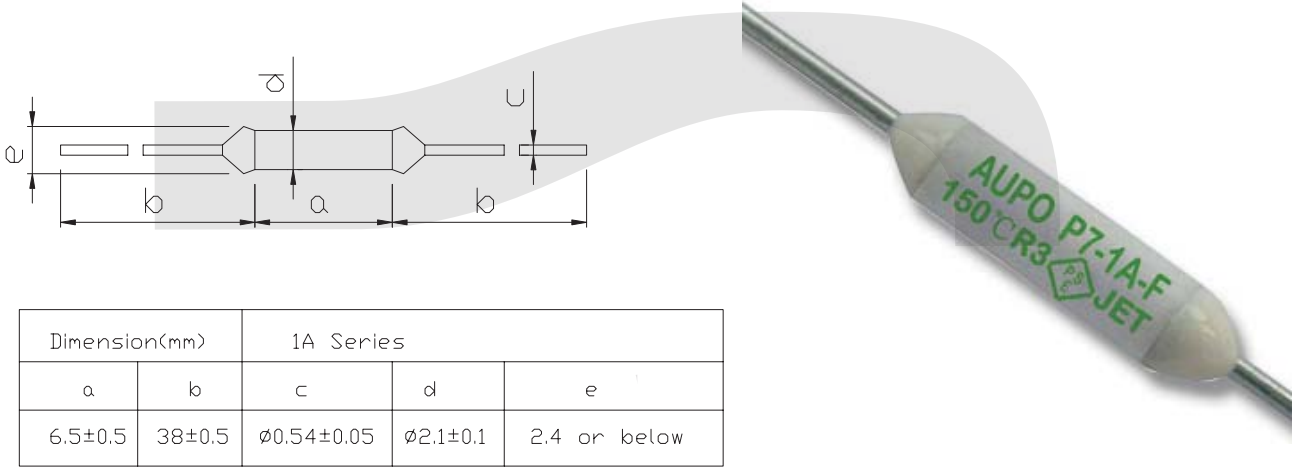

Thermal Fuse Series

KLS5-105 Porcelain tube Thermal Fuse 1A Series



Dimension(mm)		1A Series		
a	b	c	d	e
6.5±0.5	38±0.5	∅0.54±0.05	∅2.1±0.1	2.4 or below

Rated functioning temperature(Tf): The temperature at which a Thermal Cutoff changes its state of conductivity to open circuit detection current. The tolerance according to IEC60691 is from -10°C~+0°C .(With Japan Electrical Appliance and Material Law, on the other hand, they must function in the tolerance range of ±7°C).

Fusing(cut)-off temperature: The fusing-off temperature indicates value measured in silicon oil with a temperature increased by 0.5-1°C per minute and a detective current 100mA or less.

Holding temperature(Th): The maximum temperature at which a thermal Cutoff will not cause a change in state of conductivity to open circuit while conducting rated current for 168 hours. This rating is required by safety standards based on IEC60691.

Maximum temperature limit(Tm): The maximum temperature at which a Thermal Cutoff can be maintained for 10 minutes without reclosing. This rating is required by safety standards based on IEC60691.

Rated current(Ir): The allowable maximum current which a Thermal Cutoff is able to carry.

Rated voltage(Ur): The allowable maximum voltage which a Thermal Cutoff is able to be applied.

ORDER INFORMATION

Product No.: KLS5- 105 - 1A X

Part Number

Porcelain tube Thermal Fuse Series

Rated Current

Rated functioning temp

FUSE AND FUSE HOLDER

Fuse holder Series

KLS5-105 Porcelain tube Thermal Fuse 1A Series

105-1A Series													
Model No.	Rated Functioning temp.	Fusing-off temperature	Holding temperature (Th)	Maximum temp. limit	Rated current (Ir)	Rated voltage (Ur)	Safety approval						RoHS Compliance
	(Tf)			(Tm)			UL	CUL	VDE	PSE	CCC	EK	
105-1A-1	115°C	112±3°C	85°C	180°C	1A	250Vac	●	●	●	●	●	●	●
105-1A-2	125°C	120±3°C	97°C	180°C	1A	250Vac	●	●	●	●	●	●	●
105-1A-3	130°C	126±2°C	102°C	180°C	1A	250Vac	●	●	●	●	●	●	●
105-1A-4	135°C	131±3°C	105°C	180°C	1A	250Vac	●	●	●	●	●	●	●
105-1A-5	138°C	135±2°C	108°C	180°C	1A	250Vac	●	●	●	●	●	●	●
105-1A-6	150°C	145±3°C	120°C	180°C	1A	250Vac	●	●	●	●	●	●	●

ORDER INFORMATION

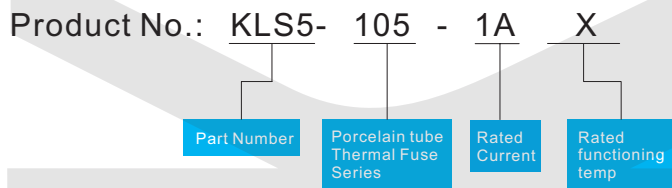



Thermal Fuse Series

KLS5-105 Porcelain tube Thermal Fuse 2A Series

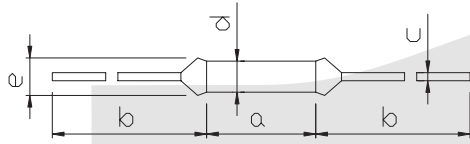

Dimension:(mm)		2A Series		
a	b	c	d	e
9.0±0.5	38±3	∅0.54±0.05	∅2.5±0.1	3.3 or below

105-2A Series													
Model No	Rated functioning temp	Fusing-off temperature	Holding temperature (Th)	Maximum temp. limit	Rated current (Ir)	Rated voltage	Safety approval						RoHS Compliance
	(Tf)			(Tm)			UL	CUL	VDE	PSE	CCC	EK	
105-2A-1	115°C	112±3°C	85°C	180°C	2A	250Vac	●	●	●	●	●	●	●
105-2A-2	125°C	120±3°C	97°C	180°C	2A	250Vac	●	●	●	●	●	●	●
105-2A-3	130°C	126±2°C	102°C	180°C	2A	250Vac	●	●	●	●	●	●	●
105-2A-4	135°C	131±3°C	105°C	180°C	2A	250Vac	●	●	●	●	●	●	●
105-2A-5	138°C	135±2°C	108°C	180°C	2A	250Vac	●	●	●	●	●	●	●
105-2A-6	150°C	145±3°C	120°C	180°C	2A	250Vac	●	●	●	●	●	●	●

ORDER INFORMATION

Product No.: KLS5- 105 - 2A X

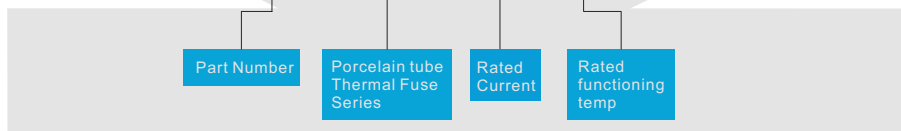

Thermal Fuse Series

KLS5-105 Porcelain tube Thermal Fuse 3A Series

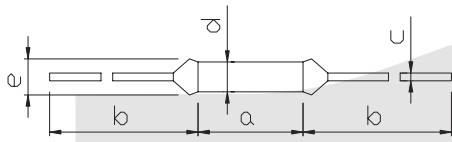

Dimension:(mm)		3A Series		
a	b	c	d	e
10.0±0.5	38±3	∅0.6±0.05	∅3.0±0.1	3.3 or below

105-3A Series												
Model No	Rated functioning temp	Fusing-off temperature	Holding temperature (Th)	Maximum temp. limit (Tm)	Rated current (Ir)	Rated voltage (Ur)	Safety approval					RoHS Compliance
	(Tf)						UL	CUL	VDE	PSE	CCC	
105-3A-1	84°C	82±2°C	55°C	180°C	3A	250Vac	●	●	●	●	●	●
105-3A-2	115°C	112±3°C	75°C	180°C	3A	250Vac	●	●	●	●	●	●
105-3A-3	125°C	120±3°C	85°C	180°C	3A	250Vac	●	●	●	●	●	●
105-3A-4	130°C	126±2°C	90°C	180°C	3A	250Vac	●	●	●	●	●	●
105-3A-5	135°C	131±3°C	90°C	180°C	3A	250Vac	●	●	●	●	●	●
105-3A-6	138°C	135±2°C	95°C	180°C	3A	250Vac	●	●	●	●	●	●
105-3A-7	150°C	145±3°C	105°C	180°C	3A	250Vac	●	●	●	●	●	●

ORDER INFORMATION

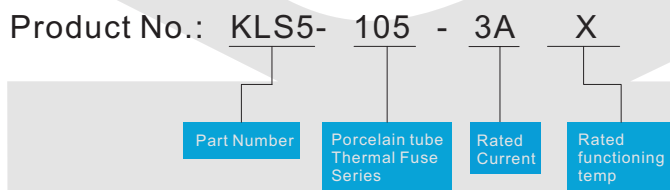

FUSE AND FUSE HOLDER

Thermal Fuse Series

KLS5-105 Porcelain tube Thermal Fuse 5A Series

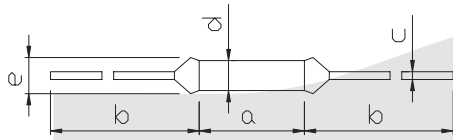

Dimension:(mm)		5A Series		
a	b	c	d	e
11.5±0.5	38±3	∅0.6±0.02	∅3.3±0.2	3.6 or below



105-5A Series												
Model No	Rated functioning temp	Fusing-off temperature	Holding temperature (Th)	Maximum temp. limit (Tm)	Rated current	Rated voltage	Safety approval					RoHS Compliance
	(Tf)				(Ir)	(Ur)	UL	CUL	VDE	PSE	CCC	
105-5A-1	84°C	82±2°C	55°C	180°C	5A	250Vac	●	●	●	●	●	●
105-5A-2	115°C	112±3°C	75°C	180°C	5A	250Vac	●	●	●	●	●	●
105-5A-3	125°C	120±3°C	85°C	180°C	5A	250Vac	●	●	●	●	●	●
105-5A-4	130°C	126±2°C	90°C	180°C	5A	250Vac	●	●	●	●	●	●
105-5A-5	135°C	131±3°C	90°C	180°C	5A	250Vac	●	●	●	●	●	●
105-5A-6	138°C	135±2°C	95°C	180°C	5A	250Vac	●	●	●	●	●	●
105-5A-7	150°C	145±3°C	105°C	180°C	5A	250Vac	●	●	●	●	●	●

ORDER INFORMATION

