

XLR CONNECTOR SERIES

KLS1-XLR-P01 Mini XLR Plug&Socket

Electrical Specification:

Rated current / voltage: 3A 250VA
The contact resistance: 5mΩMax
Insulation Resistance: 500VDC 1000MΩmin
The test voltage: 1000 VDC 1Min
The ambient temperature: -30° C ~ 100° C
The life of the product: 5000
Diameter: Φ2 ~ Φ5mm

Material:

Contact material: gold-plated copper
Insulator material: PA66, of PBT
Connector Body Material: Metal

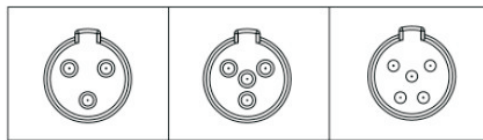
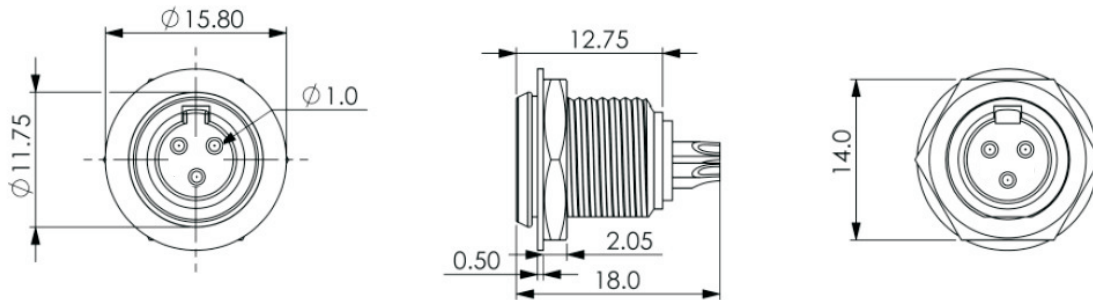

ORDER INFORMATION

Product NO.:KLS1-XLR-P01B-03

Pos. NO. _____
XLR Jack series _____ 03=3PIN or 4PIN,5PIN