

# Kumanda Butonlari ve Sinyal Lambalari

Control Units and  
Pilot Lights

### **B** Serisi Ø 22mm Kumanda Butonları (IP50)

Genel Özellikler ve Teknik Bilgiler	4
Genel Şema	5
Seçim Tablosu	6
Buton Tipleri	8
Kontakt Blok Tipleri	14
Yedekler	15
Aksesuarlar	17
Montaj Şekli ve Boyutlar	18

### **B** Series Ø 22mm Control Units (IP50)

General Specifications and Technical Information	4
General Scheme	5
Selection Table	5
Control Unit Types	8
Contact Block Types	14
Spare Parts	15
Accessories	17
Assembly and Dimensions	18

### **CM** Metal Serisi Ø 22mm Kumanda Butonları (IP65)

Genel Özellikler ve Teknik Bilgiler	19
Genel Şema	20
Seçim Tablosu	22
Buton Tipleri	24
Kontakt Blok Tipleri	29
Yedekler	30
Aksesuarlar	31
Montaj Şekli ve Boyutlar	32

### **CM** Metal Series Ø 22mm Control Units (IP65)

General Specifications and Technical Information	19
General Scheme	20
Selection Table	22
Control Unit Types	24
Contact Block Types	29
Spare Parts	30
Accessories	31
Assembly and Dimensions	32

### **CP** Plastik Serisi Ø 22mm Kumanda Butonları (IP65)

Genel Özellikler ve Teknik Bilgiler	33
Genel Şema	34
Seçim Tablosu	36
Buton Tipleri	38
Kontakt Blok Tipleri	43
Yedekler	44
Aksesuarlar	45
Montaj Şekli ve Boyutlar	47

### **CP** Plastic Series Ø 22mm Control Units (IP65)

General Specifications and Technical Information	33
General Scheme	34
Selection Table	36
Control Unit Types	38
Contact Block Types	43
Spare Parts	44
Accessories	45
Assembly and Dimensions	47

### **D** Serisi Ø 16mm Kumanda Butonları (IP50)

Genel Özellikler ve Teknik Bilgiler	48
Genel Şema	49
Seçim Tablosu	50
Buton Tipleri	51
Kontakt Blok Tipleri	53
Yedekler	53
Aksesuarlar	53
Montaj Şekli ve Boyutlar	54

### **D** Series Ø 16mm Control Units (IP50)

General Specifications and Technical Information	48
General Scheme	49
Selection Table	50
Control Unit Types	51
Contact Block Types	53
Spare Parts	53
Accessories	53
Assembly and Dimensions	54

### **H** Serisi Ø 30mm Kumanda Butonları (IP50)

Genel Özellikler ve Teknik Bilgiler	55
Genel Şema	56
Seçim Tablosu	57
Buton Tipleri	58
Kontakt Blok Tipleri	60
Montaj Şekli ve Boyutlar	61

### **H** Series Ø 30mm Control Units (IP50)

General Specifications and Technical Information	55
General Scheme	56
Selection Table	57
Control Unit Types	58
Contact Block Types	60
Assembly and Dimensions	61

### **MB** Monoblok Serisi Ø 22mm Kumanda Butonları (IP50)

Genel Özellikler ve Teknik Bilgiler	62
Genel Şema	63
Seçim Tablosu	64
Buton Tipleri	65
Aksesuarlar	67
Montaj Şekli ve Boyutlar	68

### **MB** Monoblock Series Ø 22mm Control Units (IP50)

General Specifications and Technical Information	62
General Scheme	63
Selection Table	64
Control Unit Types	65
Accessories	67
Assembly and Dimensions	68

### **KB** Serisi Ø 22mm Kumanda Butonları (IP50)

Genel Özellikler ve Teknik Bilgiler	69
Genel Şema	70
Seçim Tablosu	71
Buton Tipleri	72
Kontakt Blok Tipleri	74
Yedekler	74
Montaj Şekli ve Boyutlar	75

### **KB** Series Ø 22mm Control Units (IP50)

General Specifications and Technical Information	69
General Scheme	70
Selection Table	71
Control Unit Types	72
Contact Block Types	74
Spare Parts	74
Assembly and Dimensions	75

### **Sinyal Lambaları**

Genel Özellikler ve Teknik Bilgiler	76
Sinyal Tipleri	77
Ampuller	79
Boyutlar	80

### **Pilot Lights**

General Specifications and Technical Information	76
Pilot Light Types	77
Neon Lamps	79
Dimensions	80



## B Serisi Ø 22mm Kumanda Butonları

- Maksimum güvenlik için parmak koruma
- Darbe dayanıklı polikarbonat buton lensi
- Alev almayan VO PA6.6 kontak bloklar
- İstenildiğinde çeşitli ışıklı kontak blokların uygunluğu
- Adaptöre kontak blokların takılmasında alete ihtiyaç olmaması
- Led ışıkla, minimum ısınma maksimum ömür
- Arka arkaya 2 kontak blok takılabilir
- Farklı dillerde ve özel işaretli çeşitli markalama etiketleri
- Tüm uygulamalara cevap verecek ürün çeşitliliği.

### Teknik Bilgiler

Mekanik Ömür	: 500.000 açma-kapama min.
Elektriksel Ömür	: 100.000 açma-kapama min.
Çalışma Sıcaklığı	: min./maks. °C -5/+40
Koruma Sınıfı	: IP50
Çalışma Sıklığı	: Yüksüz 3.000 açma-kapama/saat
	: Yükte 1.200 açma-kapama/saat
Çalışma Gerilimi (Ue)	: 250 V AC
Çalışma Akımı (Ie)	: 4 A
Yalıtım Gerilimi (Ui)	: 300 V
Darbe Dayanım Gerilimi (Uimp)	: 2.5 kV
Kısa Devre Kesme Kap. (Icn)	: 1 kA
İzolasyon Direnci	: 10 MΩ min. (500 V DC)
Kullanım Sınıfı	: AC15
Dielektrik Mukavemeti	: 1.500 V AC (1 dakika için)
Standart Kontak Malzemesi	: AgNi
Bağlantı Kablo Kesiti	: 1.5 - 2.5 mm <sup>2</sup>
Standart	: UL 508 TS EN 60947-5-1 VDE0660
	: IEC 60393-1 (BPR Potansiyometre için)



## B Series Ø 22mm Control Units

- Finger safe protection for maximum safety
- Impact-resistant polycarbonate button lens
- Non-flammable VO PA6.6 contact blocks
- Various illumination contact blocks availability on request
- Tools not required to attach contact blocks to adapter
- With LED illumination, minimum warm-up and maximum lifetime.
- Contact blocks can be stacked by two blocks deep.
- Various legend plates with different languages and custom markings
- Variety of products for all areas of application

### Technical Information

Mechanical Life	: 500.000 operations min.
Electrical Life	: 100.000 operations min.
Operating Temperature	: min./max. °C -5/+40
Protection Degree	: IP50
Operating Frequency	: Without load 3.000 operations/hour
	: At full load 1.200 operations/hour
Operating Voltage (Ue)	: 250 V AC
Operating Current (Ie)	: 4 A
Insulation Voltage (Ui)	: 300 V
Impact Resistance (Uimp)	: 2.5 kV
Short Circuit Breaking Capacity (Icn)	: 1 kA
Insulation Resistance	: 10 MΩ min. (500 V DC)
Utilization Category	: AC15
Dielectric Strength	: 1.500 V AC (1 for minute)
Standard Contact Material	: AgNi
Cable Section	: 1.5 - 2.5 mm <sup>2</sup>
Standard	: UL 508 TS EN 60947-5-1 VDE0660
	: IEC 60393-1 (For BPR Potentiometer)



# Kumanda Butonları ve Sinyal Lambaları

## Control Units and Pilot Lights

### B Serisi Ø 22mm Kumanda Butonları Genel Şema

B Series Ø 22mm Control Units General Scheme

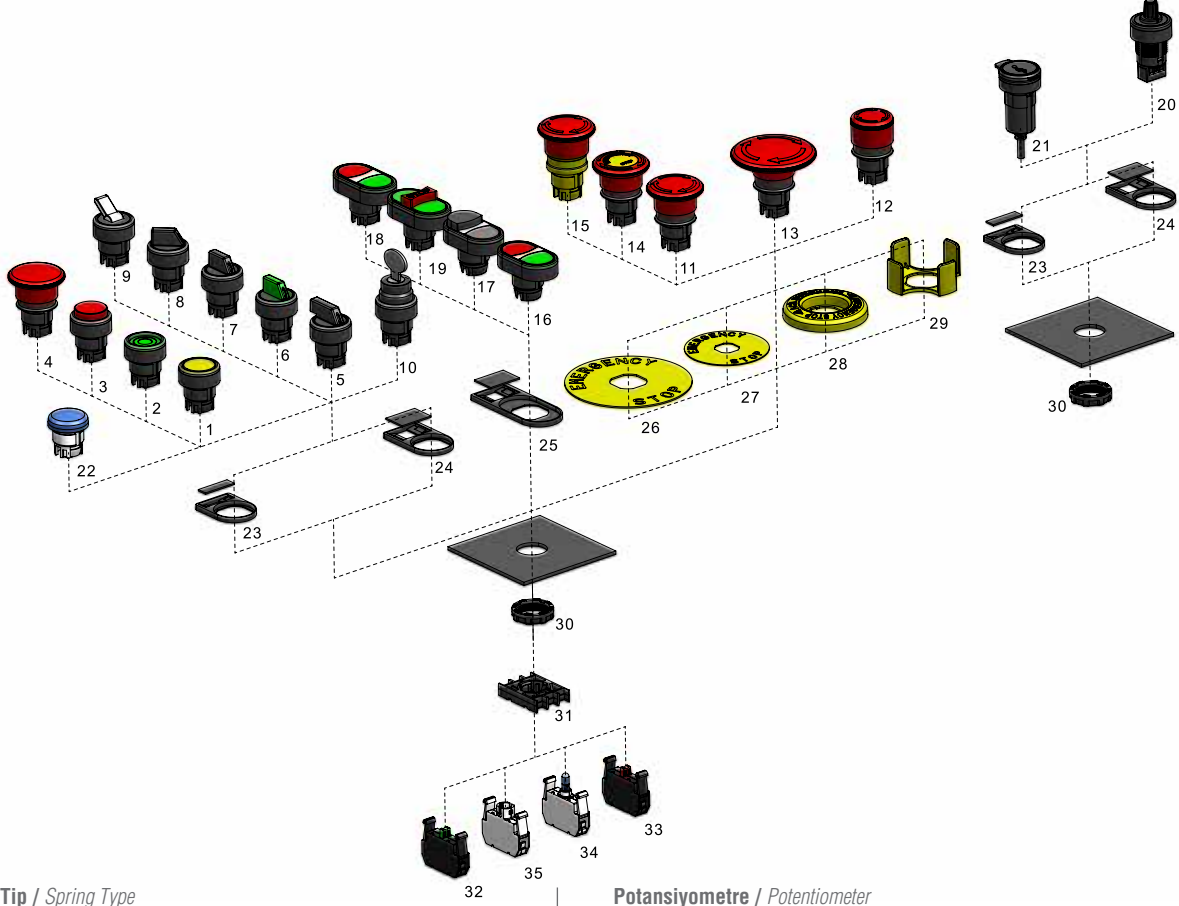

#### Yaylı Tip / Spring Type

- 1 D Düz / Flush
- 2 F Kalıcı / Stay Put
- 3 H Çıkık / Extended
- 4 M Mantar, Ø 40 mm / Mushroom, Ø 40 mm

#### Seçici Tip / Selector Type

- 5 S 60° / 60°
- 6 SL Işıklı, 60° / Illuminated, 60°
- 7 R 45° / 45°
- 8 T 90° / 90°
- 9 C Mandallı / Handle

#### 10 Anahtarlı Tip / Key Operated Type

#### Acil Stop / Emergency Stop

- 11 E Ø 40mm, Çevirmeli / Ø 40mm, Turn to Release
- 12 E30 Ø 30mm, Çevirmeli / Ø 30mm, Turn to Release
- 13 E60 Ø 60mm, Çevirmeli / Ø 60mm, Turn to Release
- 14 EE Ø 40mm, Etiketli, Çevirmeli / Ø 40mm, With Label, Turn to Release
- 15 EG Ø 40mm, Pozisyon, Göstergeli / Ø 40mm, With Position Cursor

#### Çiftli / Double

- 16 K20 Düz Kafalı / Flush
- 17 K21 1 Çıkık Kafalı / Single Extended
- 18 B20 Büyük Düz Kafalı / Big Flush
- 19 B30 Üçüz Buton, 1 Çıkık Kafalı, Stop / Triple, Single Extended, Stop

#### Potansiyometre / Potentiometer

- 20 BPR
- 21 USB

#### Sinyal / Pilots

- 22 X Yuvarlak, Sinyal / Round, Pilots

#### Aksesuarlar / Accessories

- 23 BROZET08 Rozet, 8mm / Legend Plate Holder, 8mm
- 24 BROZET18 Rozet, 18mm / Legend Plate Holder, 18mm
- 25 BCIFTLIROZET18 Rozet, İki Buton, 18mm / Legend Plate Holder, Double, 18mm
- 26 BET90A/P Etiket, Ø90mm Acil Stop, Alüminyum Plastik / Legend Plate, Ø90mm Emergency Stop, Aluminium/Plastic
- 27 BET60A/P Etiket, Ø60mm Acil Stop, Alüminyum/Plastik / Legend Plate, Ø60mm Emergency Stop, Aluminium/Plastic
- 28 BET60LED Etiket, Ø60mm Acil Stop, LED / LED Illuminated Legend Plate, Ø60mm Emergency Stop
- 29 BMUHAFAZA Emniyet Koruma / Emergency Protective Cover
- 30 SOMUN Plastic Somun, M22 X 1,5 / Plastic Nut, M22 X 1,5
- 31 ADAPTÖR Adaptör / Adapter
- 32 START KONTAKBLOK Kontak Blok, Start (NA) / Contact Block, Start (NO)
- 33 STOP KONTAKBLOK Kontak Blok, Stop (NK) / Contact Block, Stop (NC)
- 34 LED KONTAK BLOK Kontak Blok, LED / Contact Block, LED
- 35 AMPULLU LED Ba9S Duylu Işık Kontak Blok / Lampholder for Ba9S Bulbs

# Kumanda Butonları ve Sinyal Lambaları

## Control Units and Pilot Lights



### B Serisi Kumanda Butonlar Seçim Tablosu

#### Series Control Units Selection Table

Seri	Kontakt Blok Kombinasyonu	Buton Tipi
<b>B</b> Series	<b>1</b> <b>K</b> <b>2</b> Contact Block Combination	<b>D</b> Button Type
<b>Seri</b> Series <b>B</b> Serisi Ø 22mm Kumanda Butonu Series Ø 22mm Control Units	<b>Işık Bloğu Tipi</b> Illumination Block Type <b>0</b> Boş Without Illumination <b>3</b> Işık Blok Illumination Block Ba9S Ampullere Uygun Duyulu Suitable for Ba9S Bulbs <b>5</b> 12 - 30V AC/DC 12 - 30V AC/DC Beyaz LED'li With White LED <b>6</b> 12 - 30V AC/DC 12 - 30V AC/DC Kırmızı LED'li With Red LED <b>7</b> 12 - 30V AC/DC 12 - 30V AC/DC Mavi LED'li With Blue LED <b>8</b> 12 - 30V AC/DC 12 - 30V AC/DC Sarı LED'li With Yellow LED <b>9</b> 12 - 30V AC/DC 12 - 30V AC/DC Yeşil LED'li With Green LED <b>B</b> 100 - 230V AC 100 - 230V AC Beyaz LED'li With White LED <b>K</b> 100 - 230V AC 100 - 230V AC Kırmızı LED'li With Red LED <b>M</b> 100 - 230V AC 100 - 230V AC Mavi LED'li With Blue LED <b>S</b> 100 - 230V AC 100 - 230V AC Sarı LED'li With Yellow LED <b>Y</b> 100 - 230V AC 100 - 230V AC Yeşil LED'li With Green LED <b>Q</b> Özel Gerilim Special Voltage Beyaz LED'li With White LED <b>X</b> Özel Gerilim Special Voltage Kırmızı LED'li With Red LED <b>V</b> Özel Gerilim Special Voltage Mavi LED'li With Blue LED <b>W</b> Özel Gerilim Special Voltage Sarı LED'li With Yellow LED <b>Z</b> Özel Gerilim Special Voltage Yeşil LED'li With Green LED	<b>Buton Tipi</b> Button Type <b>Yaylı Tip</b> Spring Type <b>D</b> Düz Flush <b>F</b> Kalıcı Stay Put <b>H</b> Çıkık Extended <b>M</b> Mantar Mushroom Ø 40 mm Ø 40 mm <b>Seçici Tip</b> Selector Type <b>S20</b> 2 Pozisyonlu 2 Position <b>S21</b> 2 Pozisyonlu 2 Position <b>S30</b> 3 Pozisyonlu 3 Position <b>S31</b> 3 Pozisyonlu 3 Position <b>S32</b> 3 Pozisyonlu 3 Position <b>SL20</b> 2 Pozisyonlu Işıklı 2 Position Illuminated <b>SL21</b> 2 Pozisyonlu Işıklı 2 Position Illuminated <b>SL30</b> 3 Pozisyonlu Işıklı 3 Position Illuminated <b>SL31</b> 3 Pozisyonlu Işıklı 3 Position Illuminated <b>SL32</b> 3 Pozisyonlu Işıklı 3 Position Illuminated <b>R20</b> 2 Pozisyonlu 2 Position <b>R21</b> 2 Pozisyonlu 2 Position <b>T20</b> 2 Pozisyonlu 2 Position <b>T21</b> 2 Pozisyonlu 2 Position <b>C</b> Mandallı Handle
<b>Kontakt Blok Tipi</b> Contact Block Type <b>0</b> Boş Empty <b>1</b> Start Butonluk Start For Button <b>2</b> Stop Butonluk Stop For Button	<b>Kontakt Blok Tipi</b> Contact Block Type <b>0</b> Boş Empty <b>1</b> Start Butonluk Start For Button <b>2</b> Stop Butonluk Stop For Button	<b>Buton Tipi</b> Button Type <b>Kalıcı</b> Stay Put (0-1) 60° <b>Dönüşlü</b> Spring Return (0-1) 60° <b>Kalıcı</b> Stay Put (II-0-I) 60° <b>Tek Dönüşlü</b> Single Spring Return (II-0-I) 60° <b>Çift Dönüşlü</b> Double Spring Return (II-0-I) 60° <b>Kalıcı</b> Stay Put (0-1) 60° <b>Dönüşlü</b> Spring Return (0-1) 60° <b>Kalıcı</b> Stay Put (II-0-I) 60° <b>Tek Dönüşlü</b> Single Spring Return (II-0-I) 60° <b>Çift Dönüşlü</b> Double Spring Return (II-0-I) 60° <b>Kalıcı</b> Stay Put (0-1) 45° <b>Dönüşlü</b> Spring Return (0-1) 45° <b>Kalıcı</b> Stay Put (0-1) 90° <b>Dönüşlü</b> Spring Return (0-1) 90°

# Kumanda Butonları ve Sinyal Lambaları

## Control Units and Pilot Lights



Renk



Colour

Yazı



Pad Printing

### Anahtarlı Tip

Key Operated Type

<b>AA20</b>	2 Pozisyonlu 2 Position	0 Pozisyonunda Anahtarı Çıkan Key Removal at 0 Position	Kalıcı Stay Put	(0-1) (0-1)	60° 60°	✓
<b>AA21</b>	2 Pozisyonlu 2 Position	0 Pozisyonunda Anahtarı Çıkan Key Removal at 0 Position	Dönüşlü Spring Return	(0-1) (0-1)	60° 60°	↖
<b>AA30</b>	3 Pozisyonlu 3 Position	0 Pozisyonunda Anahtarı Çıkan Key Removal at 0 Position	Kalıcı Stay Put	(II-0-1) (II-0-1)	60° 60°	✓
<b>AA31</b>	3 Pozisyonlu 3 Position	0 Pozisyonunda Anahtarı Çıkan Key Removal at 0 Position	Tek Dönüşlü Single Spring Return	(II-0-1) (II-0-1)	60° 60°	↖
<b>AA32</b>	3 Pozisyonlu 3 Position	0 Pozisyonunda Anahtarı Çıkan Key Removal at 0 Position	Çift Dönüşlü Double Spring Return	(II-0-1) (II-0-1)	60° 60°	↖
<b>AC20</b>	2 Pozisyonlu 2 Position	Tüm Pozisyonlarda Anahtarı Çıkan Key Removal at all Positions	Kalıcı Stay Put	(0-1) (0-1)	60° 60°	✓
<b>AC30</b>	3 Pozisyonlu 3 Position	Tüm Pozisyonlarda Anahtarı Çıkan Key Removal at all Positions	Kalıcı Stay Put	(II-0-1) (II-0-1)	60° 60°	✓
<b>AC31</b>	3 Pozisyonlu 3 Position	Tüm Pozisyonlarda Anahtarı Çıkan Key Removal at all Positions	Tek Dönüşlü Single Spring Return	(II-0-1) (II-0-1)	60° 60°	↖
<b>AC32</b>	3 Pozisyonlu 3 Position	Tüm Pozisyonlarda Anahtarı Çıkan Key Removal at all Positions	Çift Dönüşlü Double Spring Return	(II-0-1) (II-0-1)	60° 60°	↖

### Acil Stop Tip

Emergency Stop Type

<b>E</b>	Ø 40mm Ø 40mm	Çevirmeli Turn to Release
<b>E30</b>	Ø 30mm Ø 30mm	Çevirmeli Turn to Release
<b>E60</b>	Ø 60mm Ø 60mm	Çevirmeli Turn to Release
<b>EE</b>	Ø 40mm Ø 40mm	Etiketli With Label
<b>EG</b>	Ø 40mm Ø 40mm	Pozisyon Göstergeli With Position Cursor

### Çiftli Tip

Double Type

<b>K20</b>	Düz Kafalı Flush
<b>K21</b>	1 Çıkık Kafalı Single Extended
<b>B20</b>	Büyük Düz Kafalı Big Flush
<b>B30</b>	Üçüz Buton Triple
	1 Çıkık Kafalı Single Extended
	Stop Stop

### Sinyal

Pilots

<b>X</b>	Sinyal Pilot Lights
----------	------------------------

<b>B</b>	Beyaz White
<b>K</b>	Kırmızı Red
<b>M</b>	Mavi Blue
<b>S</b>	Sarı Yellow
<b>Y</b>	Yeşil Green
<b>H</b>	Siyah Black
<b>BB</b>	Beyaz White
<b>HB</b>	Siyah Black
<b>HH</b>	Siyah Black
<b>KY</b>	Kırmızı Red
<b>SS</b>	Sarı Yellow
<b>YY</b>	Yeşil Green

<b>0</b>	0 0	Yazılı Printed
<b>10</b>	I-0 I-0	Yazılı Printed
<b>1</b>	I I	Yazılı Printed
<b>2</b>	II II	Yazılı Printed
<b>12</b>	I-II I-II	Yazılı Printed
<b>L</b>	LIGHT LIGHT	Yazılı Printed
<b>OD</b>	OK Vertical Arrow	Dikey Yazılı Printed
<b>OY</b>	OK Horizontal Arrow	Yatay Yazılı Printed
<b>OK</b>	OK Special Arrow	Özel Yazılı Printed
<b>OO</b>	OK Special Arrow	Özel Yazılı Printed
<b>S</b>	Siren İşareti Siren Symbol	Printed
<b>Z</b>	Zil İşareti Bell Symbol	Printed

**Örnek:** B1K2DK → Örnek olarak B serisi, start-stop, 100-230 V AC/DC kırmızı ledli, kırmızı renkli, düz buton seçilmiştir.

**Example:** B1K2DK → B series, start-stop, 100-230 V AC/DC with red led, red coloured, Flush type button has been selected.

# Kumanda Butonları ve Sinyal Lambaları























## Control Units and Pilot Lights



### B Serisi Ø 22 mm Adaptörlü Kumanda Butonu Tipleri

Series Ø 22 mm Push Buttons With Adapter

#### Yaylı Tip Kumanda Butonlar / Spring Type Control Units

Ürün Kodu	Kontakt Blok Tipi		Işık	Buton Tipi	Renk
Code	Contact Block Type		Illumination	Button Type	Colour
	 Normal Açık Normally Open	 Normal Kapalı Normally Closed	Opsiyonel Optional		
B100D*	1	-	√	Düz / Flush	
B101D*	2	-	√	Düz / Flush	
B102D*	1	1	√	Düz / Flush	
B200D*	-	1	√	Düz / Flush	
B202D*	-	2	√	Düz / Flush	
B100F*	1	-	√	Kalıcı / Stay Put	
B101F*	2	-	√	Kalıcı / Stay Put	
B102F*	1	1	√	Kalıcı / Stay Put	
B200F*	-	1	√	Kalıcı / Stay Put	
B202F*	-	2	√	Kalıcı / Stay Put	
B100H*	1	-	√	Çıkık / Extended	
B101H*	2	-	√	Çıkık / Extended	
B102H*	1	1	√	Çıkık / Extended	
B200H*	-	1	√	Çıkık / Extended	
B202H*	-	2	√	Çıkık / Extended	
B100M*	1	-	-	Mantar / Mushroom	
B101M*	2	-	-	Mantar / Mushroom	
B102M*	1	1	-	Mantar / Mushroom	
B200M*	-	1	-	Mantar / Mushroom	
B202M*	-	2	-	Mantar / Mushroom	

• (\*) yerine istenen rengin harfi eklenir.

• Please choose the colour and replace (\*) with the letter.

• Işık Bloğu seçenekleri için bakınız sayfa 6 Kumanda Butonları Seçim Tablosu.

• See page 6 Control Units Selection table for illumination block types.



B100DY



B100FY



B200HK



B200MK



# Kumanda Butonları ve Sinyal Lambaları

## Control Units and Pilot Lights



### Seçici Tip Kumanda Butonları / Selector Type Control Units

Ürün Kodu	Kontakt Blok Tipi	Işık	Etiket	Buton Tipi	Pozisyon	Renk
Code	Contact Block Type	Illumination	Button Plates	Button Type	Position	Colour
B100S20	1	-	0-I	Seçici / Selector	2 Pozisyonlu-Kalıcı-60° / 2 Position-Stay Put-60°	H
B101S20	2	-	0-I	Seçici / Selector	2 Pozisyonlu-Kalıcı-60° / 2 Position-Stay Put-60°	H
B102S20	1	1	0-I	Seçici / Selector	2 Pozisyonlu-Kalıcı-60° / 2 Position-Stay Put-60°	H
B100S21	1	-	0-I	Seçici / Selector	2 Pozisyonlu-Dönüşlü-60° / 2 Position-Spring Return-60°	H
B101S21	2	-	0-I	Seçici / Selector	2 Pozisyonlu-Dönüşlü-60° / 2 Position-Spring Return-60°	H
B102S21	1	1	0-I	Seçici / Selector	2 Pozisyonlu-Dönüşlü-60° / 2 Position-Spring Return-60°	H
B101S30	2	-	II-0-I	Seçici / Selector	3 Pozisyonlu-Kalıcı -60° / 3 Position-Stay Put-60°	H
B102S30	1	1	II-0-I	Seçici / Selector	3 Pozisyonlu-Kalıcı -60° / 3 Position-Stay Put-60°	H
B101S31	2	-	II-0-I	Seçici / Selector	3 Pozisyonlu-Tek Dönüşlü-60° / 3 Position-Single Spring Return-60°	H
B102S31	1	1	II-0-I	Seçici / Selector	3 Pozisyonlu-Tek Dönüşlü-60° / 3 Position-Single Spring Return-60°	H
B101S32	2	-	II-0-I	Seçici / Selector	3 Pozisyonlu-Çift Dönüşlü -60° / 3 Position-Double Spring Return-60°	H
B102S32	1	1	II-0-I	Seçici / Selector	3 Pozisyonlu-Çift Dönüşlü-60° / 3 Position-Double Spring Return-60°	H
B100SL20*	1	-	0-I	Seçici / Selector	2 Pozisyonlu-Işıklı -Kalıcı-60° / 2 Position-Illuminated-Stay Put-60°	B K M S Y H
B101SL20*	2	-	0-I	Seçici / Selector	2 Pozisyonlu-Işıklı -Kalıcı-60° / 2 Position-Illuminated-Stay Put-60°	B K M S Y H
B100SL21*	1	-	0-I	Seçici / Selector	2 Pozisyonlu-Işıklı -Dönüşlü -60° / 2 Position-Illuminated-Spring Return-60°	B K M S Y H
B101SL21*	2	-	0-I	Seçici / Selector	2 Pozisyonlu-Işıklı -Dönüşlü -60° / 2 Position-Illuminated-Spring Return-60°	B K M S Y H
B101SL30*	2	-	II-0-I	Seçici / Selector	3 Pozisyonlu-Işıklı-Kalıcı-60° / 3 Position-Illuminated-Stay Put-60°	B K M S Y H
B101SL31*	2	-	II-0-I	Seçici / Selector	3 Pozisyonlu-Işıklı-Tek Dönüşlü-60° / 3 Position-Illuminated-Single Spring Return-60°	B K M S Y H
B102SL31*	1	1	II-0-I	Seçici / Selector	3 Pozisyonlu-Işıklı-Tek Dönüşlü-60° / 3 Position-Illuminated-Single Spring Return-60°	B K M S Y H
B101SL32*	2	-	II-0-I	Seçici / Selector	3 Pozisyonlu-Işıklı-Çift Dönüşlü-60° / 3 Position-Illuminated-Double Spring Return-60°	B K M S Y H
B102SL32*	1	1	II-0-I	Seçici / Selector	3 Pozisyonlu-Işıklı-Çift Dönüşlü-60° / 3 Position-Illuminated-Double Spring Return-60°	B K M S Y H
B100R20	1	-	0-I	Seçici / Selector	2 Pozisyon-Kalıcı-45° / 2 Position-Stay Put-45°	H
B101R20	2	-	0-I	Seçici / Selector	2 Pozisyon-Kalıcı-45° / 2 Position-Stay Put-45°	H
B100R21	1	-	0-I	Seçici / Selector	2 Pozisyon-Dönüşlü-45° / 2 Position-Spring Return-45°	H
B101R21	2	-	0-I	Seçici / Selector	2 Pozisyon-Dönüşlü-45° / 2 Position-Spring Return-45°	H
B100T20	1	-	0-I	Seçici / Selector	2 Pozisyonlu-Kalıcı-90° / 2 Position-Stay Put-90°	H
B101T20	2	-	0-I	Seçici / Selector	2 Pozisyonlu-Kalıcı-90° / 2 Position-Stay Put-90°	H
B100T21	1	-	0-I	Seçici / Selector	2 Pozisyonlu-Kalıcı-90° / 2 Position-Stay Put-90°	H
B101T21	2	-	0-I	Seçici / Selector	2 Pozisyonlu-Dönüşlü-90° / 2 Position-Spring Return-90°	H
B100C	1	-	-	Mandallı / Handle Switch	-	B
B102C	1	1	-	Mandallı / Handle Switch	-	B
B200C	-	1	-	Mandallı / Handle Switch	-	B

- Işık Bloğu seçenekleri için bakınız sayfa 6 Kumanda Butonları Seçim Tablosu.
- See page 6 Control Units Selection table for illumination block types.



B100S20



B100SL20Y



B131SL30Y



B101T20



B101R20



B100C

# Kumanda Butonları ve Sinyal Lambaları

## Control Units and Pilot Lights



### B Serisi Ø 22 mm Adaptörlü Kumanda Butonu Tipleri

Series Ø 22 mm Push Buttons With Adapter

#### Anahtarlı Tip Kumanda Butonları / Key Operated Type Control Units

Ürün Kodu	Kontakt Blok Tipi	Işık	Etiket	Tip	Pozisyon	Anahtar Çıkma Pozisyonu	
Code	Contact Block Type	Illumination	Button Plates	Type	Position	Key Removal Position	
B100AA20	1	-	-	0-I	Kalıcı / Stay Put	2 Pozisyonlu / 2 Position	0
B101AA20	2	-	-	0-I	Kalıcı / Stay Put	2 Pozisyonlu / 2 Position	0
B102AA20	1	1	-	0-I	Kalıcı / Stay Put	2 Pozisyonlu / 2 Position	0
B100AA21	1	-	-	0-I	Dönüştü / Spring Return	2 Pozisyonlu / 2 Position	0
B101AA21	2	-	-	0-I	Dönüştü / Spring Return	2 Pozisyonlu / 2 Position	0
B102AA21	1	1	-	0-I	Dönüştü / Spring Return	2 Pozisyonlu / 2 Position	0
B101AA30	2	-	-	II-0-I	Kalıcı / Stay Put	3 Pozisyonlu / 3 Position	0
B102AA30	1	1	-	II-0-I	Kalıcı / Stay Put	3 Pozisyonlu / 3 Position	0
B101AA31	2	-	-	II-0-I	Tek Dönüştü / Single Spring Return	3 Pozisyonlu / 3 Position	0
B102AA31	1	1	-	II-0-I	Tek Dönüştü / Single Spring Return	3 Pozisyonlu / 3 Position	0
B101AA32	2	-	-	II-0-I	Çift Dönüştü / Double Spring Return	3 Pozisyonlu / 3 Position	0
B102AA32	1	1	-	II-0-I	Çift Dönüştü / Double Spring Return	3 Pozisyonlu / 3 Position	0
B100AC20	1	-	✓	0-I	Kalıcı / Stay Put	2 Pozisyonlu / 2 Position	Tüm / All
B101AC20	2	-	✓	0-I	Kalıcı / Stay Put	2 Pozisyonlu / 2 Position	Tüm / All
B102AC20	1	1	✓	0-I	Kalıcı / Stay Put	2 Pozisyonlu / 2 Position	Tüm / All
B100AC21	1	-	✓	0-I	Dönüştü / Spring Return	2 Pozisyonlu / 2 Position	Tüm / All
B101AC21	2	-	✓	0-I	Dönüştü / Spring Return	2 Pozisyonlu / 2 Position	Tüm / All
B102AC21	1	1	✓	0-I	Dönüştü / Spring Return	2 Pozisyonlu / 2 Position	Tüm / All
B101AC30	2	-	✓	II-0-I	Kalıcı / Stay Put	3 Pozisyonlu / 3 Position	Tüm / All
B102AC30	1	1	✓	II-0-I	Kalıcı / Stay Put	3 Pozisyonlu / 3 Position	Tüm / All
B101AC31	2	-	✓	II-0-I	Tek Dönüştü / Single Spring Return	3 Pozisyonlu / 3 Position	Tüm / All
B102AC31	1	1	-	II-0-I	Tek Dönüştü / Single Spring Return	3 Pozisyonlu / 3 Position	Tüm / All
B101AC32	2	-	-	II-0-I	Çift Dönüştü / Double Spring Return	3 Pozisyonlu / 3 Position	Tüm / All
B102AC32	1	1	-	II-0-I	Çift Dönüştü / Double Spring Return	3 Pozisyonlu / 3 Position	Tüm / All



B102AA31

# Kumanda Butonları ve Sinyal Lambaları

## Control Units and Pilot Lights



### Acil Stop Tip Kumanda Butonları / Emergency Stop Type Control Units

Ürün Kodu	Kontakt Blok Tipi		Etiket	Tip	Çap (mm)	Renk
Code	Contact Block Type		Button Plates	Type	Dia (mm)	Colour
B100E	1	-		Çevirmeli / Turn to Release	Ø 40mm	K
B102E	1	1		Çevirmeli / Turn to Release	Ø 40mm	K
B200E	-	1		Çevirmeli / Turn to Release	Ø 40mm	K
B202E	-	2		Çevirmeli / Turn to Release	Ø 40mm	K
B100EE	1	-	Etiketli / With Label	Çevirmeli / Turn to Release	Ø 40mm	K
B102EE	1	1	Etiketli / With Label	Çevirmeli / Turn to Release	Ø 40mm	K
B200EE	-	1	Etiketli / With Label	Çevirmeli / Turn to Release	Ø 40mm	K
B202EE	-	2	Etiketli / With Label	Çevirmeli / Turn to Release	Ø 40mm	K
B100EG	1	-	Pozisyon Göstergeli / With Position Cursor	Çevirmeli / Turn to Release	Ø 40mm	K
B102EG	1	1	Pozisyon Göstergeli / With Position Cursor	Çevirmeli / Turn to Release	Ø 40mm	K
B200EG	-	1	Pozisyon Göstergeli / With Position Cursor	Çevirmeli / Turn to Release	Ø 40mm	K
B202EG	-	2	Pozisyon Göstergeli / With Position Cursor	Çevirmeli / Turn to Release	Ø 40mm	K
B100E30	1	-		Çevirmeli / Turn to Release	Ø 30mm	K
B102E30	1	1		Çevirmeli / Turn to Release	Ø 30mm	K
B200E30	-	1		Çevirmeli / Turn to Release	Ø 30mm	K
B202E30	-	2		Çevirmeli / Turn to Release	Ø 30mm	K
B100E60	1	-		Çevirmeli / Turn to Release	Ø 60mm	K
B102E60	1	1		Çevirmeli / Turn to Release	Ø 60mm	K
B200E60	-	1		Çevirmeli / Turn to Release	Ø 60mm	K
B202E60	-	2		Çevirmeli / Turn to Release	Ø 60mm	K



B200E



B200E30



B200E60



B200EE



B200EG

# Kumanda Butonları ve Sinyal Lambaları

## Control Units and Pilot Lights



### B Serisi Ø 22 mm Adaptörlü Kumanda Butonu Tipleri

Series Ø 22 mm Push Buttons With Adapter

#### Çiftli Tip Kumanda Butonları / Double Type Control Units

Ürün Kodu	Kontakt Blok Tipi	Işık	Etiket	Buton Tipi	Renk		
Code	Contact Block Type	Illumination	Button Plates	Control Unit Type	Colour		
	Normal Açık Normally Open	Normal Kapalı Normally Closed	Opsiyonel Optional				
B101K20KY	2	-	√	0-I	Çiftli / Double	Düz Kafalı / Flush	
B102K20KY	1	1	√	0-I	Çiftli / Double	Düz Kafalı / Flush	
B101K21KY	2	-	√	0-I	Çiftli / Double	Çıkık Kafalı / Single Extended	
B102K21KY	1	1	√	0-I	Çiftli / Double	Çıkık Kafalı / Single Extended	
B101K20HB	2	-	√	0-I	Çiftli / Double	Düz Kafalı / Flush	
B102K20HB	1	1	√	0-I	Çiftli / Double	Düz Kafalı / Flush	
B101K21HB	2	-	√	II-0-I	Çiftli / Double	Çıkık Kafalı / Single Extended	
B102K21HB	1	1	√	II-0-I	Çiftli / Double	1 Çıkık Kafalı / Single Extended	
B101K20HH	2	-	√	II-0-I	Çiftli / Double	Düz Kafalı / Flush	
B102K20HH	1	1	√	II-0-I	Çiftli / Double	Düz Kafalı / Flush	
B101K21HH	2	-	√	II-0-I	Çiftli / Double	Çıkık Kafalı / Single Extended	
B102K21HH	1	1	√	II-0-I	Çiftli / Double	Düz Kafalı / Flush	
B101K20SH	2	-	√	0-I	Çiftli / Double	Düz Kafalı / Flush	
B102K20SH	1	1	√	0-I	Çiftli / Double	Düz Kafalı / Flush	
B101K21SH	2	-	√	0-I	Çiftli / Double	Çıkık Kafalı / Single Extended	
B102K21SH	1	1	√	0-I	Çiftli / Double	Çıkık Kafalı / Single Extended	
B101B20KY	2	-	√	0-I	Çiftli / Double	Düz Kafalı / Flush	
B102B20KY	1	1	√	0-I	Çiftli / Double	Düz Kafalı / Flush	
B101B21KY	2	-	√	II-0-I	Çiftli / Double	Çıkık Kafalı / Single Extended	
B102B21KY	1	1	√	II-0-I	Çiftli / Double	Çıkık Kafalı / Single Extended	
B101B20HB	2	-	√	II-0-I	Çiftli / Double	Düz Kafalı / Flush	
B102B20HB	1	1	√	II-0-I	Çiftli / Double	Düz Kafalı / Flush	
B101B21HB	2	-	√	II-0-I	Çiftli / Double	Çıkık Kafalı / Single Extended	
B102B21HB	1	1	√	II-0-I	Çiftli / Double	Çıkık Kafalı / Single Extended	
B121B30BB	2	1	-		Üçüz Buton / Triple	1 Çıkık Kafalı / Single Extended	
B121B30YY	2	1	-		Üçüz Buton / Triple	1 Çıkık Kafalı / Single Extended	



B102K20KY



B102B20KY



B121B30YY



B132K21HB

- Işık Bloğu seçenekleri için bakınız sayfa 6 Kumanda Butonları Seçim Tablosu.
- See page 6 Control Units Selection table for illumination block types.
- Standart çiftli buton B102K20KY, kırmızı / yeşil ve şeffaftır.
- Standard double head control unit is B102K20KY which is red/green and transparent.
- Çiftli butonda sadece kırmızı ve siyah renkli basma düğmeleri çıkıktır.
- For double head control unit, only red and black colored buttons are extended position.

# Kumanda Butonları ve Sinyal Lambaları

## Control Units and Pilot Lights



### Potansiyometre / Potentiometer

	Ürün Kodu Code				
	BPR01K	BPR02K	BPR05K	BPR10K	BPR100K
Empedans ( R ) Impedance ( R )	1 kΩ	2 kΩ	5 kΩ	10 kΩ	100 kΩ
Anma Gücü ( P ) Rated Power ( P )	Lineer 1,5W (70°C)			Lineer 1,22W (70°C)	
Koruma Sınıfı Protection Degree	IP65				
İzolasyon Direnci Isolation Resistance	min 10 MΩ (500V DC)				
Çalışma Sıcaklığı Operating Temperature	-25°C / +70°C				
Direnç Elemanı Resistive Element	Sermet / Cermet				
Elektriksel Kurs Turning Range	270° 15°				
Tolerans Tolerance	%10				
Isı Katsayısı Thermal Coefficient	%100 ppm /°C				
Dielektrik Dayanımı Dielectric Endurance	± 1750 Vrms				
Klimatik Kategori Climatic Category	55/125/56				
Maksimum Çalışma Gerilimi ( V ) Maximum Operating Voltage ( V )	38.70	54.80	86.60	122.50	350
Maksimum Fırça Akımı ( mA ) Maximum Brush Current ( mA )	38.70	27.4	17.30	12.20	3.5
Koruma Sınıfı Protection Degree	IP65				



**BPR05K**  
**5K Potansiyometre**  
5K Potentiometer

### Potansiyometre / Potentiometer

Ürün Kodu Code	Özellik Features	Renk Colour
BPR01K	1 kΩ	Seramik, Telli / Ceramic, Wired
BPR02K	2 kΩ	Seramik, Telli / Ceramic, Wired
BPR05K	5 kΩ	Seramik, Telli / Ceramic, Wired
BPR10K	10 kΩ	Seramik, Telli / Ceramic, Wired
BPR100K	100 kΩ	Seramik, Telli / Ceramic, Wired

### Bağlantı / Connection

Ürün Kodu Code	Özellik Features	Özellik Features
BUSB10	1 Metre / 1 Meter	USB Bağlantı / USB Connection
BRJ45	-	ETHERNET Bağlantı / ETHERNET Connection



**BUSB**

# Kumanda Butonları ve Sinyal Lambaları

## Control Units and Pilot Lights



### B Serisi Ø 22 mm Adaptörlü Kumanda Butonu Tipleri

#### Series Ø 22 mm Push Buttons With Adapter

#### Sinyaller / Pilot Lights

Ürün Kodu	Işık	Nominal Gerilim	Renk
Code	Illumination	Nominal Voltage	Colour
B030X*	Ba9S Duyulu		<span>B</span> <span>K</span> <span>M</span> <span>S</span> <span>Y</span> <span>H</span>
B050XB	LED	12 - 30V AC/DC	<span>B</span>
B060XK	LED	12 - 30V AC/DC	<span>K</span>
B070XM	LED	12 - 30V AC/DC	<span>M</span>
B080XS	LED	12 - 30V AC/DC	<span>S</span>
B090XY	LED	12 - 30V AC/DC	<span>Y</span>
B0B0XB	LED	100 - 230V AC	<span>B</span>
B0K0XK	LED	100 - 230V AC	<span>K</span>
B0M0XM	LED	100 - 230V AC	<span>M</span>
B0S0XS	LED	100 - 230V AC	<span>S</span>
B0Y0XY	LED	100 - 230V AC	<span>Y</span>





B080XS



B050XB

#### Kontakt Blok Tipler / Contact Block Types

Ürün Kodu	Kontakt Blok Tipi	Işık	Nominal Akım	Nominal Gerilim	Renk
Code	Contact Block Type	Illumination	Nominal Current	Nominal Voltage	Colour
	 Normal Açık Normally Open				
	 Normal Kapalı Normally Closed				
B1	1	-	4A	250V	-
B2	1	-	4A	250V	-
B3		Ba9S Duyulu	-	-	-
B5		LED	5-20mA	12-30V AC/DC	<span>B</span>
B6		LED	5-20mA	12-30V AC/DC	<span>K</span>
B7		LED	5-20mA	12-30V AC/DC	<span>M</span>
B8		LED	5-20mA	12-30V AC/DC	<span>S</span>
B9		LED	5-20mA	12-30V AC/DC	<span>Y</span>
BB		LED	5-15mA	100-230V AC	<span>B</span>
BK		LED	5-15mA	100-230V AC	<span>K</span>
BM		LED	5-15mA	100-230V AC	<span>M</span>
BS		LED	5-15mA	100-230V AC	<span>S</span>
BY		LED	5-15mA	100-230V AC	<span>Y</span>
BB4		LED	4-5mA	110V AC/DC	<span>B</span>
BK4		LED	4-5mA	110V AC/DC	<span>K</span>
BM4		LED	4-5mA	110V AC/DC	<span>M</span>
BS4		LED	4-5mA	110V AC/DC	<span>S</span>
BY4		LED	4-5mA	110V AC/DC	<span>Y</span>

- Max. 2W'lık Ba9S duylu Neon Ampul takılabilir.
- Assembly possibility only for Neon Lamp with max. 2W socket.
- • Maksimum 3 adet kontak blok arka arkaya eklenebilir.
- • Max. 3 contact blocks can be added subsequently.



B1



B2



B3



B9

# Kumanda Butonları ve Sinyal Lambaları

## Control Units and Pilot Lights



### Yedekler / Spare Parts

Ürün Kodu	Tip	Pozisyon	Renk
Code	Types	Position	Colour
BDD*	Düz / Flush		B K M S Y H
BDF*	Kalıcı / Stay Put		B K M S Y H
BDH*	Çıkık / Extended		B K M S Y H
BDM*	Mantar / Mushroom		K S Y H
BDS20	Seçici / Selector	2 Pozisyonlu-Kalıcı-60° / 2 Position-Stay Put-60°	
BDS21	Seçici / Selector	2 Pozisyonlu-Dönüşlü-60° / 2 Position-Spring Return-60°	
BDS30	Seçici / Selector	3 Pozisyonlu-Kalıcı-60° / 3 Position-Stay Put-60°	
BDS31	Seçici / Selector	3 Pozisyonlu-Tek Dönüşlü-60° / 3 Position-Single Spring Return-60°	
BDS32	Seçici / Selector	3 Pozisyonlu-Çift Dönüşlü-60° / 3 Position-Double Spring Return-60°	
BDSL20*	Seçici / Selector	2 Pozisyonlu-Işıklı-Kalıcı-60° / 2 Position-Illuminated-Stay Put-60°	B K M S Y H
BDSL21*	Seçici / Selector	2 Pozisyonlu-Işıklı-Dönüşlü-60° / 2 Position-Illuminated-Spring Return-60°	B K M S Y H
BDSL30*	Seçici / Selector	3 Pozisyonlu-Işıklı-Kalıcı-60° / 3 Position-Illuminated-Stay Put-60°	B K M S Y H
BDSL31*	Seçici / Selector	3 Pozisyonlu-Işıklı-Tek Dönüşlü-60° / 3 Position-Illuminated-Single Spring Return-60°	B K M S Y H
BDSL32*	Seçici / Selector	3 Pozisyonlu-Işıklı-Çift Dönüşlü-60° / 3 Position-Illuminated-Double Spring Return-60°	B K M S Y H
BDR20	Seçici / Selector	2 Pozisyon-Kalıcı-45° / 2 Position-Stay Put-45°	
BDR21	Seçici / Selector	2 Pozisyon-Dönüşlü-45° / 2 Position-Spring Return-45°	
BDR30	Seçici / Selector	3 Pozisyon-Kalıcı-45° / 3 Position-Stay Put-45°	
BDT20	Seçici / Selector	2 Pozisyonlu-Kalıcı-90° / 2 Position-Stay Put-90°	
BDT21	Seçici / Selector	2 Pozisyonlu-Dönüşlü-90° / 2 Position-Spring Return-90°	
BDC	Mandallı / Handle Switch		H
BDAA20	Anahtarlı / Key Operated	2 Pozisyonlu, Kalıcı / 2 Position, Stay Put	
BDAA21	Anahtarlı / Key Operated	2 Pozisyonlu, Dönüşlü / 2 Position, Spring Return	
BDAA30	Anahtarlı / Key Operated	3 Pozisyonlu, Kalıcı / 3 Position, Stay Put	
BDAA31	Anahtarlı / Key Operated	3 Pozisyonlu, Tek Dönüşlü / 3 Position, Single Spring Return	
BDAA32	Anahtarlı / Key Operated	3 Pozisyonlu, Çift Dönüşlü / 3 Position, Double Spring Return	
BDAC20	Anahtarlı / Key Operated	2 Pozisyonlu, Kalıcı / 2 Position, Stay Put	
BDAC21	Anahtarlı / Key Operated	3 Pozisyonlu, Kalıcı / 3 Position, Stay Put	
BDAC30	Anahtarlı / Key Operated	3 Pozisyonlu, Kalıcı / 3 Position, Stay Put	
BDAC31	Anahtarlı / Key Operated	3 Pozisyonlu, Tek Dönüşlü / 3 Position, Single Spring Return	
BDAC32	Anahtarlı / Key Operated	3 Pozisyonlu, Çift Dönüşlü / 3 Position, Double Spring Return	
LED24*	Ba9S Duyulu LED / Ba9S LED	24V AC/DC	B K M S Y
LED220*	Ba9S Duyulu LED / Ba9S LED	220V AC	B K M S Y



BDH



BDAA20



BDS20



BDK20KY



BDSL20Y



BDE60



BDMH



BDC



LED220K



LED24S

# Kumanda Butonları ve Sinyal Lambaları

## Control Units and Pilot Lights



### B Serisi Ø 22 mm Adaptörlü Kumanda Butonu Tipleri

Series Ø 22 mm Push Buttons With Adapter

#### Yedekler / Spare Parts

Ürün Kodu	Çap (mm)	Buton Tipi	Pozisyon	Renk
Code	Dia (mm)	Control Unit Types	Position	Colour
BDE	Ø 40mm	Acil Stop / Emergency Stop	Çevirmeli / Turn to Release	K
BDE30	Ø 30mm	Acil Stop / Emergency Stop	Çevirmeli / Turn to Release	K
BDE60	Ø 60mm	Acil Stop / Emergency Stop	Çevirmeli / Turn to Release	K
BDEE	Ø 40mm	Acil Stop / Emergency Stop	Etiketli - Çevirmeli / With Label - Turn to Release	K
BDEG	Ø 40mm	Acil Stop / Emergency Stop	Pozisyon-Göstergeli / With Position Cursor	K
BDK20KY		Çiftli / Double	Düz Kafalı / Flush	K Y
BDK21KY		Çiftli / Double	1 Çıkık Kafalı / Single Extended	K Y
BDK20HB		Çiftli / Double	Düz Kafalı / Flush	B H
BDK21HB		Çiftli / Double	1 Çıkık Kafalı / Single Extended	B H
BDK20HH		Çiftli / Double	Düz Kafalı / Flush	B H
BDK21HH		Çiftli / Double	1 Çıkık Kafalı / Single Extended	B H
BDK20SH		Çiftli / Double	Düz Kafalı / Flush	S H
BDK21SH		Çiftli / Double	1 Çıkık Kafalı / Single Extended	S H
BDB20KY		Çiftli / Double	Düz Kafalı / Flush	K Y
BDB21KY		Çiftli / Double	Düz Kafalı / Flush	K Y
BDB20HB		Çiftli / Double	Düz Kafalı / Flush	B K Y H
BDB21HB		Çiftli / Double	Düz Kafalı / Flush	B K Y H
BDB30BB		Üçüz Buton / Triple	Düz Kafalı / Flush	B K Y B
BDB30YY		Üçüz Buton / Triple	-	K Y Y
BDX*		Sinyal / Pilot Lights	-	B K M S Y

#### Özel Tampon Baskılı Butonlar / Special Pad Printed Control Units

Ürün Kodu / Code	B102K20KY-10	B101K20YY-12	B101K20YY-OK	B102K20HB-10	B101K20HH-OK	B101K20BB-12	B101K20SH-10	B101K20SS-12
Baskı / Print	I-O	I-II	Oklu / Arrow Symbol	I-O	Oklu / Arrow Symbol	I-II	I-O	I-II
Ürün Kodu / Code	B100DY-OD	B100DY-OY	B100DH-OD	B100DH-OY	B100DB-OD	B100DB-OY	B100DB-Z	B100DB-L
Baskı / Print	Dikey Oklu Vertical Arrow	Yatay Oklu Horizontal Arrow	Dikey Oklu Vertical Arrow	Yatay Oklu Horizontal Arrow	Dikey Oklu Vertical Arrow	Yatay Oklu Horizontal Arrow	Zil / Bell	Lamba / Lamp
Ürün Kodu / Code	B100DY-1	B100DY-2	B100DB-1	B100DB-2	B200DK-0	B200DH-0	B200DS-Z	B200DS-L
Baskı / Print	I	II	I	II	O	O	Zil / Bell	Lamba / Lamp



# Kumanda Butonları ve Sinyal Lambaları

## Control Units and Pilot Lights



### Aksesuarlar / Accessories

Ürün Kodu	Tip	Özellik	Özellik	Malzeme
Code	Types	Features	Features	Material
BA	Adaptör / Adapter			Plastik / Plastic
B-ANAHTAR	Anahtar / Key			
BBUTONORTA	Kontak Baskı Parçası / Middle Contact Activator	Düz Buton 22mm / Flush Button 22mm		
BCIFTLİROZET18	Çiftli Rozet / Double Legend Plate Holder	18mm		
BEB	Etanj Başlık / Silicon Cover	Düz Buton 22mm / Flush Button 22mm		
BEBK20	Etanj Başlık / Silicon Cover	Çiftli Butonlar / Double Buttons		
BEBK21	Etanj Başlık / Silicon Cover	1 Çıkık Kafalı-Çiftli Butonlar Single Extended-Double Buttons		
BMUHAFAZA	Emniyet Koruma / Emergency Protective Cover	Darbe Muhafaza / Stroke Protection		
BPROT	Buton Koruma / Protective Cover	Darbe Muhafaza / Stroke Protection		
BPUL	Pul / Plate	Buton Sıkıştırma / Button Tightening		
BROZET08	Rozet / Legend Plate Holder	8mm		
BROZET18	Rozet / Legend Plate Holder	18mm		
BSECICIORTA	Kontak Baskı Parçası / Middle Contact Activator	Tek Dönümlü Seçici Buton Single Spring Return Selector Button		
BSOMAN	Somun Anahtar / Nut Tightener			
BET08	Etiket / Legend Plate	8mm	BOŞ	
BET08-01	Etiket / Legend Plate	8mm	(0-1)	
BET08-01OK	Etiket / Legend Plate	8mm	(0-1) OKLU	
BET08-12	Etiket / Legend Plate	8mm	(I-II)	
BET08-201	Etiket / Legend Plate	8mm	(2-0-1)	
BET08-201OK	Etiket / Legend Plate	8mm	(2-0-1) OKLU	
BET08-201OK2	Etiket / Legend Plate	8mm	(2-0-1) ÇİFT OKLU	
BET08-START	Etiket / Legend Plate	8mm	START	
BET08-STOP	Etiket / Legend Plate	8mm	STOP	
BET18	Etiket / Legend Plate	18mm	BOŞ	
BET18-01	Etiket / Legend Plate	18mm	(0-1)	
BET18-START	Etiket / Legend Plate	18mm	START	
BET48P	Etiket / Legend Plate	48mm	EMERGENCY	Plastik / Plastic
BET60A	Etiket / Legend Plate	60mm	ACİL STOP	Alüminyum / Aluminium
BET60LED1	Etiket-Işıklı-24V AC/DC Legend Plate-With LED-24V AC/DC	60mm	ACİL STOP-EMERGENCY	
BET60LED2	Etiket-Işıklı-24V AC/DC Legend Plate-With LED-24V AC/DC	60mm	EMERGENCY STOP EMERGENCY STOP	
BET60P	Etiket / Legend Plate	60mm	EMERGENCY STOP	Plastik / Plastic
BET60P1	Etiket / Legend Plate	60mm	ACİL DURDURMA	Plastik / Plastic
BET60P2	Etiket / Legend Plate	60mm	ARRET D'URGENCE	Plastik / Plastic
BET90A	Etiket / Legend Plate	90mm	ACİL STOP	Alüminyum / Aluminium
BET90P	Etiket / Legend Plate	90mm	ACİL STOP	Plastik / Plastic
BET90P-1	Etiket / Legend Plate	90mm	ACİL DURDURMA	Plastik / Plastic



# Kumanda Butonları ve Sinyal Lambaları

## Control Units and Pilot Lights



### MONTAJ ŞEKLİ / ASSEMBLY

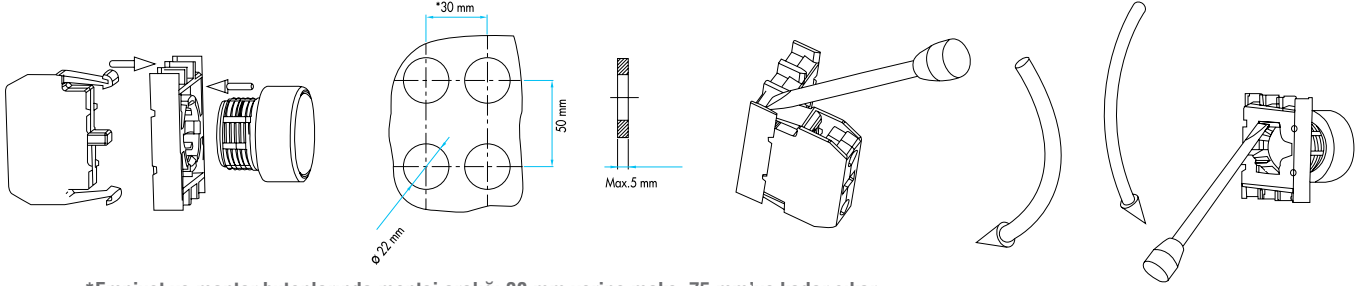

\*Emniyet ve mantar butonlarında montaj aralığı 30 mm yerine maks. 75 mm'ye kadar çıkar.  
The mounting distance in emergency and mushroom buttons increases up to max. 75 mm instead of 30 mm

### BOYUTLAR (mm) / DIMENSIONS (mm)

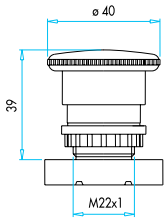

**Acil Stop Ø 40 mm**  
Emergency Stop Ø 40 mm

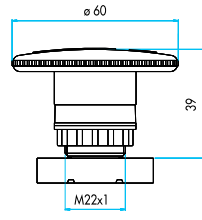

**Acil Stop Ø 60 mm**  
Emergency Stop Ø 60 mm

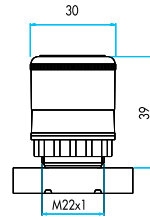

**Acil Stop Ø 30 mm**  
Emergency Stop Ø 30 mm

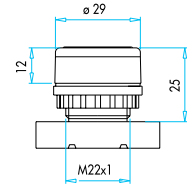

**Düz**  
Flush

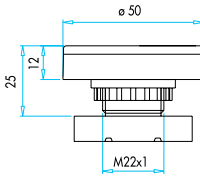

**Çiftli Düz Kafalı**  
Double, Spring Return

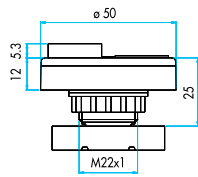

**Çiftli Çıkık Kafalı**  
Double Extended, Spring Return

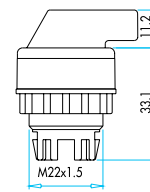

**Seçici**  
Selector

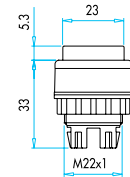

**Çıkık Kafalı**  
Extended, Spring Return

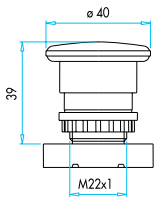

**Mantar**  
Mushroom, Spring Return

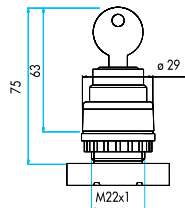

**Anahtarlı**  
Key Operated

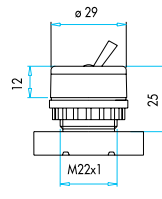

**Mandallı**  
Handle Button

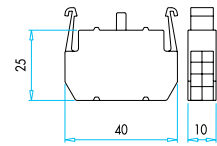

**B Serisi Kontak Blok**  
B Series Contact Block

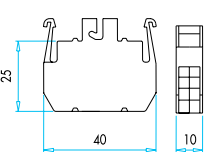

**B Serisi Ampul Takılabilen Işıklı Blok**  
Neon Lamp Mountable  
B Series Light Block

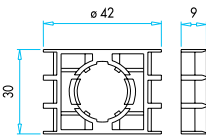

**Adaptör**  
Adapter

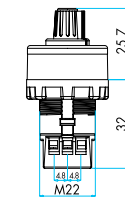

**Potansiyometre**  
Potentiometer

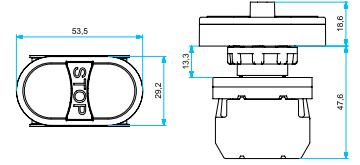

**Üçüz Buton**  
Triple, With Extended Stop



## CM Serisi Metal Ø 22mm Kumanda Buton Tipleri

- Ağır koşullara dayanıklı metal yapı, korozyona karşı krom kaplama
- Maksimum güvenlik için parmak koruma
- Darbe dayanıklı polikarbonat buton lensi
- Alev almayan V0 PA6.6 kontak bloklar
- İstenildiğinde çeşitli ışıklı kontak blokların uygunluğu
- Kolaylıkla tek elle adaptörün sökülebilmesi, adaptöre kontak blokların takılmasında alete ihtiyaç olmaması
- Led ışıkla, minimum ısınma maksimum ömür
- Arka arkaya 2 kontak blok takılabilir
- Farklı dillerde ve özel işaretli çeşitli markalama etiketleri
- Üstün silikon conta tekniği ile IP65 koruma
- Tüm uygulamalara cevap verecek ürün çeşitliliği

### Teknik Bilgiler

Mekanik Ömür	: 500.000 açma-kapama min.
Elektriksel Ömür	: 100.000 açma-kapama min.
Çalışma Sıcaklığı	: min./maks. °C -5/+40
Koruma Sınıfı	: IP65
Çalışma Sıklığı	: Yüksüz 3.000 açma-kapama/saat
	: Yükte 1.200 açma-kapama/saat
Çalışma Gerilimi (Ue)	: 230 V AC
Çalışma Akımı (Ie)	: 4 A
Yalıtım Gerilimi (Ui)	: 300 V
Darbe Dayanım Gerilimi (Uimp)	: 2.5 kV
Kısa Devre Kesme Kap. (Icn)	: 1 kA
İzolasyon Direnci	: 10 MΩ min. (500 V DC)
Kullanım Sınıfı	: AC15
Dielektrik Mukavemeti	: 1.500 V AC (1dk. için)
Standart Kontak Malzemesi	: AgNi
Bağlantı Kablo Kesiti	: 1.5 - 2.5 mm <sup>2</sup>
Standart	: UL 508 TS EN 60947-5-1 VDE0660



## CM Series Metal Ø 22mm Control Units Types

- Die cast metal construction for harsh environment, corrosion-resistant chromate plating
- Finger safe protection for maximum safety
- Impact-resistant polycarbonate button lens
- Non-flammable V0 PA6.6 contact blocks
- Various illumination contact blocks availability on request
- Easy one-hand adapter removal, tools not required to attach contact blocks to adapter
- With LED illumination, minimum warm-up and maximum lifetime.
- Compact design contact blocks can be stacked by 2 blocks deep
- Various legend plates with different languages and custom markings
- IP65 protection degree with superior silicone sealing techniques
- Variety of products for all areas of application

### Technical Information

Mechanical Life	: 500.000 operations min.
Electrical Life	: 100.000 operations min.
Operating Temperature	: min./max. °C -5/+40
Protection Degree	: IP65
Operating Frequency	: Without load 3.000 operations/hour
	: At full load 1.200 operations/hour
Operating Voltage (Ue)	: 230 V AC
Operating Current (Ie)	: 4 A
Insulation Voltage (Ui)	: 300 V
Impact Resistance (Uimp)	: 2.5 kV
Short Circuit Breaking Capacity (Icn)	: 1 kA
Insulation Resistance	: 10 MΩ min. (500 V DC)
Utilization Category	: AC15
Dielectric Strength	: 1.500 V AC (for 1 minute)
Standard Contact Material	: AgNi
Cable Section	: 1.5 - 2.5 mm <sup>2</sup>
Standard	: UL 508 TS EN 60947-5-1 VDE0660



# Kumanda Butonları ve Sinyal Lambaları

## Control Units and Pilot Lights



### CM Metal Serisi Ø 22mm Kumanda Butonları Genel Şema

CM Metal Series Ø 22mm Control Units General Scheme

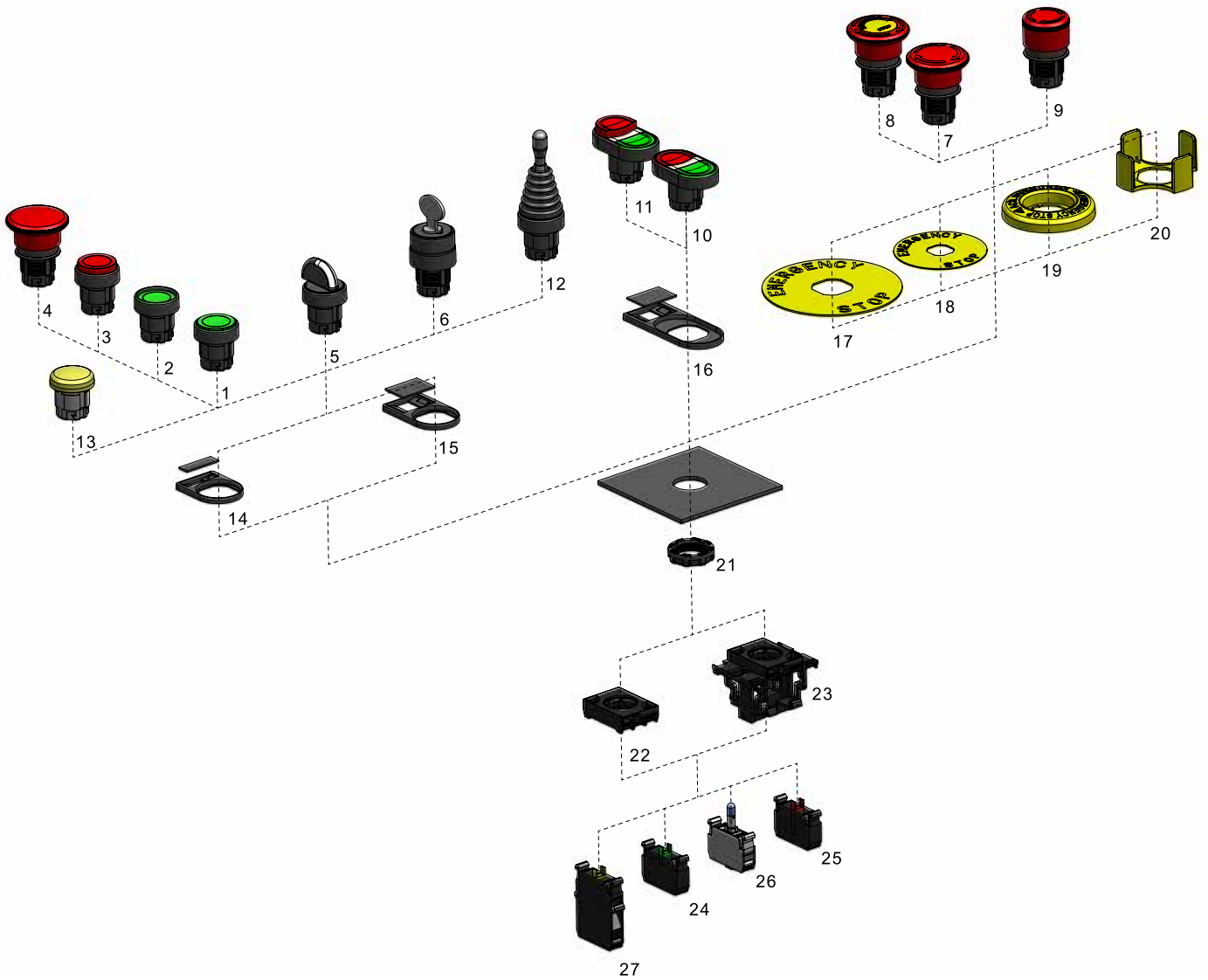

# Kumanda Butonları ve Sinyal Lambaları

## Control Units and Pilot Lights



	<b>Yaylı Tip / Spring Type</b>	
1	D	Düz / Flush
2	F	Kalıcı / Stay Put
3	H	Çıkık / Extended
4	M	Mantar, Ø 40 mm / Mushroom, Ø 40 mm
	<b>Seçici Tip / Selector Type</b>	
5	S	60° / 60°
	<b>Anahtarlı Tip / Key Operated Type</b>	
6		
	<b>Acil Stop / Emergency Stop Type</b>	
7	E	Ø 40mm, Çevirmeli / Ø 40mm, Turn to Release
8	EE	Ø 40mm, Etiketli, Çevirmeli / Ø 40mm, With Label, Turn to Release
9	EK30	
	<b>Çiftli / Double</b>	
10	K20	Düz Kafalı / Flush
11	K21	1 Çıkık kafalı / Single Extended
	<b>Joystick Tip / Joystick</b>	
12	DJ20	2 Pozisyonlu, Kalıcı / 2 Position, Stay Put
12	DJ21	2 Pozisyonlu, Dönüştü / 2 Position, Spring Return
12	DJ40	4 Pozisyonlu, Kalıcı / 4 Position, Stay Put
12	DJ41	4 Pozisyonlu, Dönüştü / 4 Position, Spring Return
	<b>Sinyal / Pilots</b>	
13	X	Yuvarlak, Sinyal / Round, Pilots
	<b>Aksesuarlar / Accessories</b>	
14	BROZET08	Rozet, 8mm / Legend Plate Holder, 8mm
15	BROZET18	Rozet, 18mm / Legend Plate Holder, 18mm
16	BCIFTLIROZET18	Rozet, İkiz Buton, 18mm / Legend Plate Holder, Double, 18mm
17	BET90A/P	Etiket, Ø90mm Acil Stop, Alüminyum/Plastik Legend Plate, Ø90mm Emergency Stop, Aluminium/Plastic
18	BET60A/P	Etiket, Ø60mm Acil Stop, Alüminyum/Plastik Legend Plate, Ø60mm Emergency Stop, Aluminium/Plastic
19	BET60LED	Etiket, Ø60mm Acil Stop, Led LED Illuminated Legend Plate, Ø60mm Emergency Stop
20	CMUHFAZA	Emniyet Koruma / Emergency Protective Cover
21	SOMUN	Plastic Somun, M22 X 1,5 / Plastic Nut, M22 X 1,5
22	ADAPTÖR	Adaptör / Adapter
23	EKLİ ADAPTÖR	Ek adaptör / Additional Adapter
24	START KONTAKBLOK	Kontak Blok, Start (NA) / Contact Block, Start (NO)
25	STOP KONTAKBLOK	Kontak Blok, Stop (NK) / Contact Block, Stop (NC)
26	LED KONTAKBLOK	Kontak Blok, LED / Contact Block, LED
27	JOYSTİK KONTAKBLOK	Kontak, Joystick / Contact Block, Joystick

# Kumanda Butonları ve Sinyal Lambaları

## Control Units and Pilot Lights



### CM Serisi Kumanda Butonlar Seçim Tablosu

#### Series Control Units Selection Table

Seri	Kontakt Blok Kombinasyonu			Buton Tipi																																																																																				
CM	1	K	2	D																																																																																				
Series	Contact Block Combination			Button Type																																																																																				
<b>Seri Series</b> <b>CM</b> Metal Serisi Ø 22mm Kumanda Butonları Metal Series Ø 22mm Control Units	<b>Kontakt Blok Tipi</b> Contact Block Type	<b>Kontakt Blok Tipi</b> Contact Block Type	<b>Acil Stop Tip</b> Emergency Stop Type	<b>Çiftli Tip</b> Double Type																																																																																				
	<table border="1"> <tr><td>0</td><td>Boş</td><td></td><td></td></tr> <tr><td>1</td><td>Start</td><td>Butonluk</td><td></td></tr> <tr><td>2</td><td>Stop</td><td>Butonluk</td><td></td></tr> <tr><td>3</td><td>Yanyana</td><td>Start</td><td>Start</td></tr> <tr><td>4</td><td>Yanyana</td><td>Start</td><td>Stop</td></tr> <tr><td>5</td><td>Yanyana</td><td>Stop</td><td>Stop</td></tr> <tr><td>6</td><td>Start</td><td>Start</td><td>Düşey</td></tr> <tr><td>7</td><td>Start</td><td>Stop</td><td>Joystick İçin</td></tr> </table>	0	Boş			1	Start	Butonluk		2	Stop	Butonluk		3	Yanyana	Start	Start	4	Yanyana	Start	Stop	5	Yanyana	Stop	Stop	6	Start	Start	Düşey	7	Start	Stop	Joystick İçin	<table border="1"> <tr><td>0</td><td>Boş</td><td></td><td></td></tr> <tr><td>1</td><td>Start</td><td>Butonluk</td><td></td></tr> <tr><td>2</td><td>Stop</td><td>Butonluk</td><td></td></tr> <tr><td>3</td><td>Yanyana</td><td>Start</td><td>Start</td></tr> <tr><td>4</td><td>Yanyana</td><td>Start</td><td>Stop</td></tr> <tr><td>5</td><td>Yanyana</td><td>Stop</td><td>Stop</td></tr> <tr><td>6</td><td>Start</td><td>Start</td><td>Düşey</td></tr> <tr><td>7</td><td>Start</td><td>Stop</td><td>Joystick İçin</td></tr> </table>	0	Boş			1	Start	Butonluk		2	Stop	Butonluk		3	Yanyana	Start	Start	4	Yanyana	Start	Stop	5	Yanyana	Stop	Stop	6	Start	Start	Düşey	7	Start	Stop	Joystick İçin	<table border="1"> <tr><td>E</td><td>Ø 40mm</td><td></td><td>Çevirmeli</td></tr> <tr><td>EE</td><td>Ø 40mm</td><td>Etiketli</td><td>Çevirmeli</td></tr> <tr><td>EK30</td><td>Ø 30mm</td><td>Kısa</td><td>Çevirmeli*</td></tr> </table>	E	Ø 40mm		Çevirmeli	EE	Ø 40mm	Etiketli	Çevirmeli	EK30	Ø 30mm	Kısa	Çevirmeli*	<table border="1"> <tr><td>K20</td><td>Düz Kafalı</td><td></td><td></td></tr> <tr><td>K21</td><td>1 Çıkık Kafalı</td><td></td><td></td></tr> </table>	K20	Düz Kafalı			K21	1 Çıkık Kafalı		
0	Boş																																																																																							
1	Start	Butonluk																																																																																						
2	Stop	Butonluk																																																																																						
3	Yanyana	Start	Start																																																																																					
4	Yanyana	Start	Stop																																																																																					
5	Yanyana	Stop	Stop																																																																																					
6	Start	Start	Düşey																																																																																					
7	Start	Stop	Joystick İçin																																																																																					
0	Boş																																																																																							
1	Start	Butonluk																																																																																						
2	Stop	Butonluk																																																																																						
3	Yanyana	Start	Start																																																																																					
4	Yanyana	Start	Stop																																																																																					
5	Yanyana	Stop	Stop																																																																																					
6	Start	Start	Düşey																																																																																					
7	Start	Stop	Joystick İçin																																																																																					
E	Ø 40mm		Çevirmeli																																																																																					
EE	Ø 40mm	Etiketli	Çevirmeli																																																																																					
EK30	Ø 30mm	Kısa	Çevirmeli*																																																																																					
K20	Düz Kafalı																																																																																							
K21	1 Çıkık Kafalı																																																																																							
	<b>İşık Bloğu Tipi</b> Illumination Block Type		<b>Joystick Tip</b> Joystick Type	<b>Sinyal</b> Pilot Lights																																																																																				
	<table border="1"> <tr><td>0</td><td>Boş</td><td></td><td></td></tr> <tr><td>5</td><td>12 - 30V AC/DC</td><td>Beyaz LED'li</td><td></td></tr> <tr><td>6</td><td>12 - 30V AC/DC</td><td>Kırmızı LED'li</td><td></td></tr> <tr><td>7</td><td>12 - 30V AC/DC</td><td>Mavi LED'li</td><td></td></tr> <tr><td>8</td><td>12 - 30V AC/DC</td><td>Sarı LED'li</td><td></td></tr> <tr><td>9</td><td>12 - 30V AC/DC</td><td>Yeşil LED'li</td><td></td></tr> <tr><td>B</td><td>100 - 230V AC</td><td>Beyaz LED'li</td><td></td></tr> <tr><td>K</td><td>100 - 230V AC</td><td>Kırmızı LED'li</td><td></td></tr> <tr><td>M</td><td>100 - 230V AC</td><td>Mavi LED'li</td><td></td></tr> <tr><td>S</td><td>100 - 230V AC</td><td>Sarı LED'li</td><td></td></tr> <tr><td>Y</td><td>100 - 230V AC</td><td>Yeşil LED'li</td><td></td></tr> <tr><td>Q</td><td>Özel Gerilim</td><td>Beyaz LED'li</td><td></td></tr> <tr><td>X</td><td>Özel Gerilim</td><td>Kırmızı LED'li</td><td></td></tr> <tr><td>V</td><td>Özel Gerilim</td><td>Mavi LED'li</td><td></td></tr> <tr><td>W</td><td>Özel Gerilim</td><td>Sarı LED'li</td><td></td></tr> <tr><td>Z</td><td>Özel Gerilim</td><td>Yeşil LED'li</td><td></td></tr> </table>	0	Boş			5	12 - 30V AC/DC	Beyaz LED'li		6	12 - 30V AC/DC	Kırmızı LED'li		7	12 - 30V AC/DC	Mavi LED'li		8	12 - 30V AC/DC	Sarı LED'li		9	12 - 30V AC/DC	Yeşil LED'li		B	100 - 230V AC	Beyaz LED'li		K	100 - 230V AC	Kırmızı LED'li		M	100 - 230V AC	Mavi LED'li		S	100 - 230V AC	Sarı LED'li		Y	100 - 230V AC	Yeşil LED'li		Q	Özel Gerilim	Beyaz LED'li		X	Özel Gerilim	Kırmızı LED'li		V	Özel Gerilim	Mavi LED'li		W	Özel Gerilim	Sarı LED'li		Z	Özel Gerilim	Yeşil LED'li			<table border="1"> <tr><td>DJ20</td><td>2 Pozisyonlu</td><td>Kalıcı</td><td></td></tr> <tr><td>DJ21</td><td>2 Pozisyonlu</td><td>Dönüşlü</td><td></td></tr> <tr><td>DJ40</td><td>4 Pozisyonlu</td><td>Kalıcı</td><td></td></tr> <tr><td>DJ41</td><td>4 Pozisyonlu</td><td>Dönüşlü</td><td></td></tr> </table>	DJ20	2 Pozisyonlu	Kalıcı		DJ21	2 Pozisyonlu	Dönüşlü		DJ40	4 Pozisyonlu	Kalıcı		DJ41	4 Pozisyonlu	Dönüşlü		<table border="1"> <tr><td>X</td><td>Sinyal</td><td></td><td></td></tr> </table>	X	Sinyal		
0	Boş																																																																																							
5	12 - 30V AC/DC	Beyaz LED'li																																																																																						
6	12 - 30V AC/DC	Kırmızı LED'li																																																																																						
7	12 - 30V AC/DC	Mavi LED'li																																																																																						
8	12 - 30V AC/DC	Sarı LED'li																																																																																						
9	12 - 30V AC/DC	Yeşil LED'li																																																																																						
B	100 - 230V AC	Beyaz LED'li																																																																																						
K	100 - 230V AC	Kırmızı LED'li																																																																																						
M	100 - 230V AC	Mavi LED'li																																																																																						
S	100 - 230V AC	Sarı LED'li																																																																																						
Y	100 - 230V AC	Yeşil LED'li																																																																																						
Q	Özel Gerilim	Beyaz LED'li																																																																																						
X	Özel Gerilim	Kırmızı LED'li																																																																																						
V	Özel Gerilim	Mavi LED'li																																																																																						
W	Özel Gerilim	Sarı LED'li																																																																																						
Z	Özel Gerilim	Yeşil LED'li																																																																																						
DJ20	2 Pozisyonlu	Kalıcı																																																																																						
DJ21	2 Pozisyonlu	Dönüşlü																																																																																						
DJ40	4 Pozisyonlu	Kalıcı																																																																																						
DJ41	4 Pozisyonlu	Dönüşlü																																																																																						
X	Sinyal																																																																																							

# Kumanda Butonları ve Sinyal Lambaları

## Control Units and Pilot Lights



Renk



Colour

Yazı



Pad Printing

### Buton Tipi

Button Type

### Yaylı Tip

Spring Type

<b>D</b>	Düz Flush
<b>F</b>	Kalıcı Stay Put
<b>H</b>	Çıkık Extended
<b>M</b>	Mantar Ø 40 mm Mushroom Ø 40 mm

### Seçici Tip

Selector Type

<b>S20</b>	2 Pozisyonlu 2 Position	Kalıcı Stay Put	(0-I) (0-I)	60° 60°	↙
<b>S21</b>	2 Pozisyonlu 2 Position	Dönüslü Spring Return	(0-I) (0-I)	60° 60°	↗
<b>S30</b>	3 Pozisyonlu 3 Position	Kalıcı Stay Put	(II-0-I) (II-0-I)	60° 60°	↙
<b>S31</b>	3 Pozisyonlu 3 Position	Tek Dönüslü Single Spring Return	(II-0-I) (II-0-I)	60° 60°	↘
<b>S32</b>	3 Pozisyonlu 3 Position	Çift Dönüslü Double Spring Return	(II-0-I) (II-0-I)	60° 60°	↕

### Anahtarlı Tip

Key Operated Type

<b>AA20</b>	2 Pozisyonlu 2 Position	0 Pozisyonunda Anahtarı Çıkan Key Removal at 0 Position	Kalıcı Stay Put	(0-I) (0-I)	60° 60°	↙
<b>AA21</b>	2 Pozisyonlu 2 Position	0 Pozisyonunda Anahtarı Çıkan Key Removal at 0 Position	Dönüslü Spring Return	(0-I) (0-I)	60° 60°	↗
<b>AA30</b>	3 Pozisyonlu 3 Position	0 Pozisyonunda Anahtarı Çıkan Key Removal at 0 Position	Kalıcı Stay Put	(II-0-I) (II-0-I)	60° 60°	↙
<b>AA31</b>	3 Pozisyonlu 3 Position	0 Pozisyonunda Anahtarı Çıkan Key Removal at 0 Position	Tek Dönüslü Single Spring Return	(II-0-I) (II-0-I)	60° 60°	↘
<b>AA32</b>	3 Pozisyonlu 3 Position	0 Pozisyonunda Anahtarı Çıkan Key Removal at 0 Position	Çift Dönüslü Double Spring Return	(II-0-I) (II-0-I)	60° 60°	↕
<b>AC20</b>	2 Pozisyonlu 2 Position	Tüm Pozisyonlarda Anahtarı Çıkan Key Removal at all Positions	Kalıcı Stay Put	(0-I) (0-I)	60° 60°	↙
<b>AC30</b>	3 Pozisyonlu 3 Position	Tüm Pozisyonlarda Anahtarı Çıkan Key Removal at all Positions	Kalıcı Stay Put	(II-0-I) (II-0-I)	60° 60°	↙
<b>AC31</b>	3 Pozisyonlu 3 Position	Tüm Pozisyonlarda Anahtarı Çıkan Key Removal at all Positions	Tek Dönüslü Single Spring Return	(II-0-I) (II-0-I)	60° 60°	↘
<b>AC32</b>	3 Pozisyonlu 3 Position	Tüm Pozisyonlarda Anahtarı Çıkan Key Removal at all Positions	Çift Dönüslü Double Spring Return	(II-0-I) (II-0-I)	60° 60°	↕

<b>B</b>	Beyaz White		
<b>K</b>	Kırmızı Red		
<b>M</b>	Mavi Blue		
<b>S</b>	Sarı Yellow		
<b>Y</b>	Yeşil Green		
<b>H</b>	Siyah Black		
<b>BB</b>	Beyaz White	Beyaz White	
<b>HB</b>	Siyah Black	Beyaz White	
<b>HH</b>	Siyah Black	Siyah Black	
<b>KY</b>	Kırmızı Red	Yeşil Green	
<b>SS</b>	Sarı Yellow	Sarı Yellow	
<b>YY</b>	Yeşil Green	Yeşil Green	
<b>0</b>	0 0		Yazılı Printed
<b>10</b>	I-0 I-0		Yazılı Printed
<b>1</b>	I I		Yazılı Printed
<b>2</b>	II II		Yazılı Printed
<b>12</b>	I-II I-II		Yazılı Printed
<b>L</b>	LIGHT LIGHT		Yazılı Printed
<b>OD</b>	OK Vertical Arrow		Dikey Yazılı Printed
<b>OY</b>	OK Horizontal Arrow		Yatay Yazılı Printed
<b>OK</b>	OK Special Arrow		Özel Yazılı Printed
<b>OO</b>	OK Special Arrow		Özel Yazılı Printed
<b>S</b>	Siren İşareti Siren Symbol		Printed
<b>Z</b>	Zil İşareti Siren Symbol		Printed

**Örnek:** CM1K2DK → Örnek olarak CM metal serisi, start-stop, 100-230 V AC/DC kırmızı ledli, kırmızı renkli, düz, yuvarlak buton seçilmiştir.

**Example:** CM1K2DK → CM series, start-stop, 100-230 V AC/DC with red led, red, Flush type button has been selected.

# Kumanda Butonları ve Sinyal Lambaları

## Control Units and Pilot Lights

EMES®

### CM Metal Ø 22 mm Kumanda Buton Tipleri

Metal Ø 22 mm Control Units Types

#### Yaylı Tip Kumanda Butonlar / Spring Type Control Units

Ürün Kodu	Kontakt Blok Tipi		Işık	Buton Tipi	Renk
Code	Contact Block Type		Illumination	Button Type	Colour
	Normal Açık Normally Open	Normal Kapalı Normally Closed	Opsiyonel Optional		
CM100D*	1	-	√	Düz / Flush	B K M S Y H
CM101D*	2	-	√	Düz / Flush	B K M S Y H
CM102D*	1	1	√	Düz / Flush	B K M S Y H
CM200D*	-	1	√	Düz / Flush	B K M S Y H
CM202D*	-	2	√	Düz / Flush	B K M S Y H
CM303D*	4	-	√	Düz / Flush	B K M S Y H
CM305D*	2	2	√	Düz / Flush	B K M S Y H
CM101F*	2	-	√	Kalıcı / Stay Put	B K M S Y H
CM102F*	1	1	√	Kalıcı / Stay Put	B K M S Y H
CM200F*	-	1	√	Kalıcı / Stay Put	B K M S Y H
CM202F*	-	2	√	Kalıcı / Stay Put	B K M S Y H
CM101H*	1	1	√	Çıkık / Extended	B K M S Y H
CM102H*	1	1	√	Çıkık / Extended	B K M S Y H
CM200H*	-	1	√	Çıkık / Extended	B K M S Y H
CM202H*	-	2	√	Çıkık / Extended	B K M S Y H
CM100M*	1	-	-	Mantar / Mushroom	K S Y H
CM101M*	2	-	-	Mantar / Mushroom	K S Y H
CM102M*	1	1	-	Mantar / Mushroom	K S Y H
CM200M*	-	1	-	Mantar / Mushroom	K S Y H
CM202M*	-	2	-	Mantar / Mushroom	K S Y H

• (\*) yerine istenen rengin harfi eklenir.

• Please choose the colour and replace (\*) with the letter.

• • Işık Bloğu seçenekleri için bakınız sayfa 22 Kumanda Butonları Seçim Tablosu.

• • See page 22 Control Units Selection table for illumination block types.



CM100DY



CM100HY



CM200MK



# Kumanda Butonları ve Sinyal Lambaları

## Control Units and Pilot Lights



### Seçici Tip Kumanda Butonları / Selector Type Control Units

Ürün Kodu	Kontakt Blok Tipi	Işık	Etiket	Buton Tipi	Pozisyon	Renk	
Code	Contact Block Type	Illumination	Button Plates	Button Type	Position	Colour	
	 Normal Açık Normally Open	 Normal Kapalı Normally Closed	LED LED				
CM100S20	1	-	√	0-I	Seçici / Selector	2 Pozisyonlu-Kalıcı-60° / 2 Position-Stay Put-60°	H
CM101S20	2	-	√	0-I	Seçici / Selector	2 Pozisyonlu-Kalıcı-60° / 2 Position-Stay Put-60°	H
CM102S20	1	1	√	0-I	Seçici / Selector	2 Pozisyonlu-Kalıcı-60° / 2 Position-Stay Put-60°	H
CM100S21	1	-	√	0-I	Seçici / Selector	2 Pozisyonlu-Kalıcı-60° / 2 Position-Stay Put-60°	H
CM101S21	2	-	√	0-I	Seçici / Selector	2 Pozisyonlu-Kalıcı-60° / 2 Position-Stay Put-60°	H
CM102S21	1	1	√	0-I	Seçici / Selector	2 Pozisyonlu-Kalıcı-60° / 2 Position-Stay Put-60°	H
CM101S30	2	-	√	II-0-I	Seçici / Selector	3 Pozisyonlu-Kalıcı-60° / 3 Position-Stay Put-60°	H
CM102S30	1	1	√	II-0-I	Seçici / Selector	3 Pozisyonlu-Kalıcı-60° / 3 Position-Stay Put-60°	H
CM101S31	2	-	√	II-0-I	Seçici / Selector	3 Pozisyonlu-Tek Dönüştü-60° / 3 Position-Single Spring Return-60°	H
CM102S31	1	1	√	II-0-I	Seçici / Selector	3 Pozisyonlu-Tek Dönüştü-60° / 3 Position-Single Spring Return-60°	H
CM101S32	2	-	√	II-0-I	Seçici / Selector	3 Pozisyonlu-Çift Dönüştü -60° / 3 Position-Double Spring Return-60°	H
CM102S32	1	1	√	II-0-I	Seçici / Selector	3 Pozisyonlu-Çift Dönüştü -60° / 3 Position-Double Spring Return-60°	H

- Işık Bloğu seçenekleri için bakınız sayfa 22 Kumanda Butonları Seçim Tablosu.
- See page 22 Control Units Selection table for illumination block types.



CM100S20

# Kumanda Butonları ve Sinyal Lambaları

## Control Units and Pilot Lights



### CM Metal Ø 22 mm Kumanda Buton Tipleri

Metal Ø 22 mm Control Units Types

#### Anahtarlı Tip Kumanda Butonları / Key Operated Type Control Units

Ürün Kodu	Kontakt Blok Tipi	Etiket	Tip	Pozisyon	Anahtar Çıkma Pozisyonu
Code	Contact Block Type	Button Plates	Type	Position	Key Removal Position
CM100AA20	1	-	(0-I) Kalıcı / Stay Put	2 Pozisyonlu / 2 Position	✓ 0
CM101AA20	2	-	(0-I) Kalıcı / Stay Put	2 Pozisyonlu / 2 Position	✓ 0
CM102AA20	1	1	(0-I) Kalıcı / Stay Put	2 Pozisyonlu / 2 Position	✓ 0
CM100AA21	1	-	(0-I) Dönüşlü / Spring Return	2 Pozisyonlu / 2 Position	↖ 0
CM101AA21	2	-	(0-I) Dönüşlü / Spring Return	2 Pozisyonlu / 2 Position	↖ 0
CM102AA21	1	1	(0-I) Dönüşlü / Spring Return	2 Pozisyonlu / 2 Position	↖ 0
CM101AA30	2	-	(II-0-I) Kalıcı / Stay Put	3 Pozisyonlu / 3 Position	✓ 0
CM102AA30	1	1	(II-0-I) Kalıcı / Stay Put	3 Pozisyonlu / 3 Position	✓ 0
CM101AA31	2	-	(II-0-I) Tek Dönüşlü / Single Spring Return	3 Pozisyonlu / 3 Position	↖ 0
CM102AA31	1	1	(II-0-I) Tek Dönüşlü / Single Spring Return	3 Pozisyonlu / 3 Position	↖ 0
CM101AA32	2	-	(II-0-I) Çift Dönüşlü / Double Spring Return	3 Pozisyonlu / 3 Position	↖ 0
CM101AA32	2	-	(II-0-I) Çift Dönüşlü / Double Spring Return	3 Pozisyonlu / 3 Position	↖ 0
CM100AC20	1	-	(0-I) Kalıcı / Stay Put	2 Pozisyonlu / 2 Position	✓ Tüm / All
CM101AC20	2	-	(0-I) Kalıcı / Stay Put	2 Pozisyonlu / 2 Position	✓ Tüm / All
CM102AC20	1	1	(0-I) Kalıcı / Stay Put	2 Pozisyonlu / 2 Position	✓ Tüm / All
CM100AC21	1	-	(0-I) Dönüşlü / Spring Return	2 Pozisyonlu / 2 Position	↖ Tüm / All
CM101AC21	2	-	(0-I) Dönüşlü / Spring Return	2 Pozisyonlu / 2 Position	↖ Tüm / All
CM102AC21	1	1	(0-I) Dönüşlü / Spring Return	2 Pozisyonlu / 2 Position	↖ Tüm / All
CM101AC30	2	-	(II-0-I) Kalıcı / Stay Put	3 Pozisyonlu / 3 Position	✓ Tüm / All
CM102AC30	1	1	(II-0-I) Kalıcı / Stay Put	3 Pozisyonlu / 3 Position	✓ Tüm / All
CM101AC31	2	-	(II-0-I) Tek Dönüşlü / Single Spring Return	3 Pozisyonlu / 3 Position	↖ Tüm / All
CM102AC31	1	1	(II-0-I) Tek Dönüşlü / Single Spring Return	3 Pozisyonlu / 3 Position	↖ Tüm / All
CM101AC32	2	-	(II-0-I) Çift Dönüşlü / Double Spring Return	3 Pozisyonlu / 3 Position	↖ Tüm / All
CM101AC32	2	-	(II-0-I) Çift Dönüşlü / Double Spring Return	3 Pozisyonlu / 3 Position	↖ Tüm / All





CM100AC20

# Kumanda Butonları ve Sinyal Lambaları

## Control Units and Pilot Lights



### Acil Stop Tip Kumanda Butonları / Emergency Stop Type Control Units

Ürün Kodu	Kontak Blok Tipi	Etiket	Tip	Çap (mm)	Renk
Code	Contact Block Type	Button Plates	Type	Dia (mm)	Colour
	 Normal Açık Normally Open	 Normal Kapalı Normally Closed			
CM100E	1	-	Çevirmeli / Turn to Release	Ø 40mm	K S
CM102E	1	1	Çevirmeli / Turn to Release	Ø 40mm	K S
CM200E	-	1	Çevirmeli / Turn to Release	Ø 40mm	K S
CM202E	-	2	Çevirmeli / Turn to Release	Ø 40mm	K S
CM100EE	1	-	Etiketli - Çevirmeli / With Label - Turn to Release	Ø 40mm	K
CM102EE	1	1	Etiketli - Çevirmeli / With Label - Turn to Release	Ø 40mm	K
CM200EE	-	1	Etiketli - Çevirmeli / With Label - Turn to Release	Ø 40mm	K
CM202EE	-	2	Etiketli - Çevirmeli / With Label - Turn to Release	Ø 40mm	K
CM100EK30	1	-	Çevirmeli Kısa / Turn to Release	Ø 30mm	K
CM102EK30	1	1	Çevirmeli Kısa / Turn to Release	Ø 30mm	K
CM200EK30	-	1	Çevirmeli Kısa / Turn to Release	Ø 30mm	K
CM202EK30	-	2	Çevirmeli Kısa / Turn to Release	Ø 30mm	K





CM200E



CM200EE

### Çiftli Tip Kumanda Butonları / Double Type Control Units

Ürün Kodu	Kontak Blok Tipi	Işık	Buton Tipi	Renk		
Code	Contact Block Type	Illumination	Control Unit Type	Colour		
	 Normal Açık Normally Open	 Normal Kapalı Normally Closed				
		Opsiyonel Optional				
CM102K20HB	1	1	✓	Çiftli / Double	Düz Kafalı / Flush	B H
CM102K20HS	1	1	✓	Çiftli / Double	Düz Kafalı / Flush	S H
CM102K20KY	1	1	✓	Çiftli / Double	Düz Kafalı / Flush	K Y
CM102K21HB	1	1	✓	Çiftli / Double	1 Çıkık Kafalı / Single Extended	B H
CM102K21KY	1	1	✓	Çiftli / Double	1 Çıkık Kafalı / Single Extended	K Y

- Işık Bloğu seçenekleri için bakınız sayfa 22 Kumanda Butonları Seçim Tablosu.
- See page 22 Control Units Selection table for illumination block types.

- • Standart çiftli buton B102K20KY, kırmızı / yeşil ve şeffaftır.
- • Standard double head control unit is B102K20KY which is red/green and transparent.
- • • Çiftli butonda sadece kırmızı ve siyah renkli basma düğmeleri çıkıktır.
- • • For double head control unit, only red and black colored buttons are extended position.



CM102K20KY

# Kumanda Butonları ve Sinyal Lambaları



## Control Units and Pilot Lights



### CM Metal Ø 22 mm Kumanda Buton Tipleri

#### Metal Ø 22 mm Control Units Types

#### Joystick Tip Kumanda Butonları / Joystick Type Control Units

Ürün Kodu	Kontakt Blok Tipi	Etiket	Tip	Pozisyon	Renk
Code	Contact Block Type	Button Plates	Type	Position	Colour
					
CM101DJ20	2	-	Kalıcı / Stay Put	2 Pozisyonlu / 2 Position	H
CM101DJ21	2	-	Dönüşlü / Spring Return	2 Pozisyonlu / 2 Position	H
CM102DJ21	1	-	Dönüşlü / Spring Return	2 Pozisyonlu / 2 Position	H
CM707DJ40	4	-	Kalıcı / Stay Put	2 Pozisyonlu / 2 Position	H
CM707DJ41	4	-	Dönüşlü / Spring Return	2 Pozisyonlu / 2 Position	H



CM707DJ40



CM101DJ20

#### Sinyaller / Pilot Lights

Ürün Kodu	Işık	Ürün Kodu	Nominal Gerilim	Renk
Code	Illumination	Nominal Voltage	Colour	
CM050XB	LED	12 - 30V AC/DC	B	
CM060XK	LED	12 - 30V AC/DC	K	
CM070XM	LED	12 - 30V AC/DC	M	
CM080XS	LED	12 - 30V AC/DC	S	
CM090XY	LED	12 - 30V AC/DC	Y	
CM0B0XB	LED	100 - 230V AC	B	
CM0K0XK	LED	100 - 230V AC	K	
CM0M0XM	LED	100 - 230V AC	M	
CM0S0XS	LED	100 - 230V AC	S	
CM0Y0XY	LED	100 - 230V AC	Y	



CM090XY



CM050XB



CM0B0XB



CM0M0XM



CM0S0XS

# Kumanda Butonları ve Sinyal Lambaları

## Control Units and Pilot Lights



### Kontakt Blok Tipler / Contact Block Types

Ürün Kodu	Kontakt Blok Tipi	İşık	Nominal Akım	Nominal Gerilim	Kullanım Yeri	Özellik	Renk
Code	Contact Block Type	Illumination	Nominal Current	Nominal Voltage	Place of Use	Features	Colour
	 Normal Açık Normally Open	 Normal Kapalı Normally Closed					
C1	1	-	4A	230V	Butonluk / For Control Units		
C1AU	1	-	4A	230V	Butonluk -Altın Kaplamalı For Control Units-Gold Plated	Altın Kaplama / Gold Plated	
C2	-	1	4A	230V	Butonluk / For Control Units		
C2AU	-	1	4A	230V	Butonluk -Altın Kaplamalı For Control Units-Gold Plated	Altın Kaplama / Gold Plated	
C12	2	-	4A	230V	Joystick- Butonluk Joystick For Control Units		
CB5		LED	5-20mA	12-30V AC/DC	Butonluk / For Control Units		B
CB6		LED	5-20mA	12-30V AC/DC	Butonluk / For Control Units		K
CB7		LED	5-20mA	12-30V AC/DC	Butonluk / For Control Units		M
CB8		LED	5-20mA	12-30V AC/DC	Butonluk / For Control Units		S
CB9		LED	5-20mA	12-30V AC/DC	Butonluk / For Control Units		Y
CBB		LED	5-15mA	100-230V AC	Butonluk / For Control Units		B
CBK		LED	5-15mA	100-230V AC	Butonluk / For Control Units		K
CBM		LED	5-15mA	100-230V AC	Butonluk / For Control Units		M
CBS		LED	5-15mA	100-230V AC	Butonluk / For Control Units		S
CBY		LED	5-15mA	100-230V AC	Butonluk / For Control Units		Y
CBB4		LED	4-5mA	110V AC/DC	Butonluk / For Control Units		B
CBK4		LED	4-5mA	110V AC/DC	Butonluk / For Control Units		K
CBM4		LED	4-5mA	110V AC/DC	Butonluk / For Control Units		M
CBS4		LED	4-5mA	110V AC/DC	Butonluk / For Control Units		S
CBY4		LED	4-5mA	110V AC/DC	Butonluk / For Control Units		Y

• Maksimum 2 adet kontak blok arka arkaya eklenebilir.

• Max. 2 contact blocks can be added subsequently.

•• C1AU, C2AU Altın kaplamalı kontak blok.

•• C1AU, C2AU gold plated contact block.

••• C12, Joystick kontak blok.

••• C12, Joystick contact block.



C1



C2



CBB

# Kumanda Butonları ve Sinyal Lambaları

## Control Units and Pilot Lights



### CM Metal Ø 22 mm Kumanda Buton Tipleri

#### Metal Ø 22 mm Control Units Types

#### Yedekler / Spare Parts

Ürün Kodu Code	Buton Tipi Control Unit Types	Pozisyon Position	Renk Colour
CMDD*	Düz / Flush		
CMDF*	Kalıcı / Stay, Put		
CMDH*	Çıkık / Extended		
CMDM*	Mantar / Mushroom		
CMDS20	Seçici / Selector	2 Pozisyonlu-Kalıcı-60° / 2 Position-Stay Put-60°	
CMDS21	Seçici / Selector	2 Pozisyonlu-Dönüşlü-60° / 2 Position-Spring Return-60°	
CMDS30	Seçici / Selector	3 Pozisyonlu-Kalıcı -60° / 3 Position-Stay Put-60°	
CMDS31	Seçici / Selector	3 Pozisyonlu-Tek Dönüşlü-60° / 3 Position-Single Spring Return-60°	
CMDS32	Seçici / Selector	3 Pozisyonlu-Çift Dönüşlü -60° / 3 Position-Double Spring Return-60°	
CMDAA20	Anahtarlı / Key Operated	2 Pozisyonlu, Kalıcı / 2 Position, Stay Put	
CMDAA21	Anahtarlı / Key Operated	2 Pozisyonlu-Dönüşlü / 2 Position-Spring Return	
CMDAA30	Anahtarlı / Key Operated	3 Pozisyonlu-Kalıcı / 3 Position-Stay Put	
CMDAA31	Anahtarlı / Key Operated	3 Pozisyonlu-Tek Dönüşlü / 3 Position-Single Spring Return	
CMDAC20	Anahtarlı / Key Operated	2 Pozisyonlu, Kalıcı / 2 Position, Stay Put	
CMDAC21	Anahtarlı / Key Operated	2 Pozisyonlu-Dönüşlü / 2 Position-Spring Return	
CMDAC30	Anahtarlı / Key Operated	3 Pozisyonlu-Kalıcı / 3 Position-Stay Put	
CMDAC31	Anahtarlı / Key Operated	3 Pozisyonlu-Tek Dönüşlü / 3 Position-Single Spring Return	
CMDAC32	Anahtarlı / Key Operated	3 Pozisyonlu-Çift Dönüşlü / 3 Position-Double Spring Return	
CMDK20HB	Çiftli / Double	Düz Kafalı / Flush	
CMDK20KY	Çiftli / Double	Düz Kafalı / Flush	
CMDK21HB	Çiftli / Double	1 Çıkık Kafalı / Single Extended	
CMDK21KY	Çiftli / Double	1 Çıkık Kafalı / Single Extended	
CMDJ20	Joystick	2 Pozisyonlu-Kalıcı / 2 Position-Stay Put	
CMDJ21	Joystick	2 Pozisyonlu-Dönüşlü / 2 Position-Spring Return	
CMDJ40	Joystick	4 Pozisyonlu-Kalıcı / 4 Position-Stay Put	
CMDJ41	Joystick	4 Pozisyonlu-Dönüşlü / 4 Position-Spring Return	
CMDX*	Sinyal / Pilot Lights		

#### Özel Tampon Baskılı Butonlar / Special Pad Printed Control Units

Ürün Kodu / Code								
Baskı / Print	CM102K20KY-10	CM101K20YY-12	CM101K20YY-OK	CM102K20HB-10	CM101K20HH-OK	CM101K20BB-12	CM101K20SH-10	CM101K20SS-12
Ürün Kodu / Code								
Baskı / Print	CM100DY-OD	CM100DY-OY	CM100DH-OD	CM100DH-OY	CM100DB-OD	CM100DB-OY	CM100DB-Z	CM100DB-L
Ürün Kodu / Code								
Baskı / Print	CM100DY-1	CM100DY-2	CM100DB-1	CM100DB-2	CM200DK-0	CM200DH-0	CM200DS-Z	CM200DS-L

Not: Minimum Sipariş miktarı 50 Adettir.  
Note : Minimum Order Quantity : 50 pcs

# Kumanda Butonları ve Sinyal Lambaları

## Control Units and Pilot Lights



### Aksesuarlar / Accessories

Ürün Kodu Code	Tip Types	Özellik Features	Etiket Button Plates	Malzeme Material
BCIFTLİROZET18	Çiftli Rozet / Double Legend Plate Holder	18mm		
BEB	Etanj Başlık / Silicon Cover	Düz Buton 22mm / Flush Button 22mm		
BEBK20	Etanj Başlık / Silicon Cover	Çiftli Butonlar / Double Buttons		
BEBK21	Etanj Başlık / Silicon Cover	1 Çıkık Kafalı-Çiftli Butonlar Single Extended -Double Buttons		
BMUHAFAZA	Emniyet Koruma / Emergency Protective Cover	Darbe Muhafaza / Stroke Protection		
BPROT	Buton Koruma / Protective Cover	Darbe Muhafaza / Stroke Protection		
BPUL	Pul / Plate	Buton Sıkıştırma / Button Tightening		
BROZET08	Rozet / Legend Plate Holder	8mm		
BROZET18	Rozet / Legend Plate Holder	18mm		
BSOMAN	Somun Anahtarları / Nut Tightener			
BET08	Etiket / Legend Plate	8mm	BOŞ	
BET08-01	Etiket / Legend Plate	8mm	(0-1)	
BET08-01OK	Etiket / Legend Plate	8mm	(0-1) OKLU	
BET08-12	Etiket / Legend Plate	8mm	(I-II)	
BET08-201	Etiket / Legend Plate	8mm	(2-0-1)	
BET08-201OK	Etiket / Legend Plate	8mm	(2-0-1) OKLU	
BET08-201OK2	Etiket / Legend Plate	8mm	(2-0-1) ÇİFT OKLU	
BET08-START	Etiket / Legend Plate	8mm	START	
BET08-STOP	Etiket / Legend Plate	8mm	STOP	
BET18	Etiket / Legend Plate	18mm	BOŞ	
BET18-01	Etiket / Legend Plate	18mm	(0-1)	
BET18-START	Etiket / Legend Plate	18mm	START	
BET48P	Etiket / Legend Plate	48mm	EMERGENCY	Plastik / Plastic
BET60A	Etiket / Legend Plate	60mm	ACİL STOP	Alüminyum / Aluminium
BET60LED1	Etiket-Işıklı-24V AC/DC Plate-With LED-24V AC/DC	60mm	ACİL STOP- EMERGENCY	
BET60LED2	Etiket-Işıklı-24V AC/DC Plate-With LED-24V AC/DC	60mm	EMERGENCY STOP - EMERGENCY STOP	
BET60P	Etiket / Legend Plate	60mm	EMERGENCY STOP	Plastik / Plastic
BET60P1	Etiket / Legend Plate	60mm	ACİL DURDURMA	Plastik / Plastic
BET60P2	Etiket / Legend Plate	60mm	ARRET D'URGENCE	Plastik / Plastic
BET90A	Etiket / Legend Plate	90mm	ACİL STOP	Alüminyum / Aluminium
BET90P	Etiket / Legend Plate	90mm	ACİL STOP	Plastik / Plastic
BET90P-1	Etiket / Legend Plate	90mm	ACİL DURDURMA	Plastik / Plastic



BROZET18



BROZET08



BET60LED1



BET60LED2



BET60P



BPUL



BPROT



BMUHAFAZA

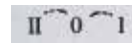

BET08-201OK2



BET08-201OK



BET08



BET18



BET08-START

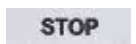

BET08-STOP



BET08-01



BET08-01OK



BET08-201

### MONTAJ ŞEKLİ / ASSEMBLY

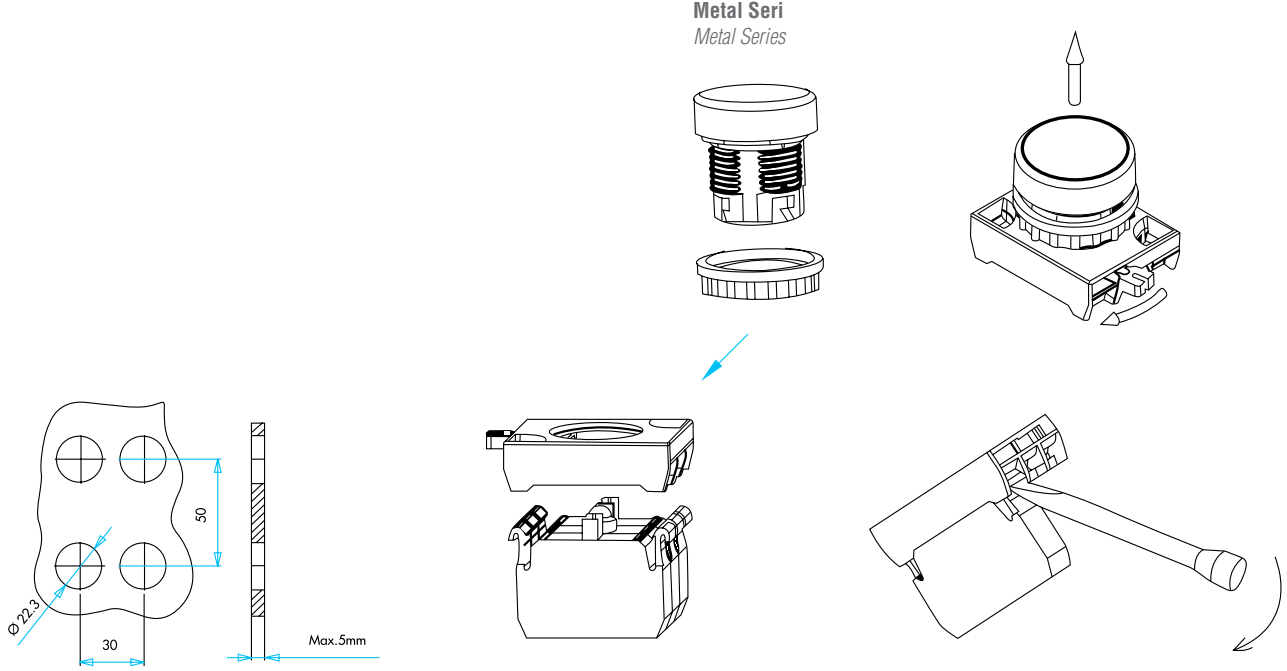

Emniyet ve mantar butonlarında 30 mm ölçüsü 45 mm'dir.  
30 mm size is 45 mm in emergency and mushroom buttons.

### BOYUTLAR (mm) / DIMENSIONS (mm)

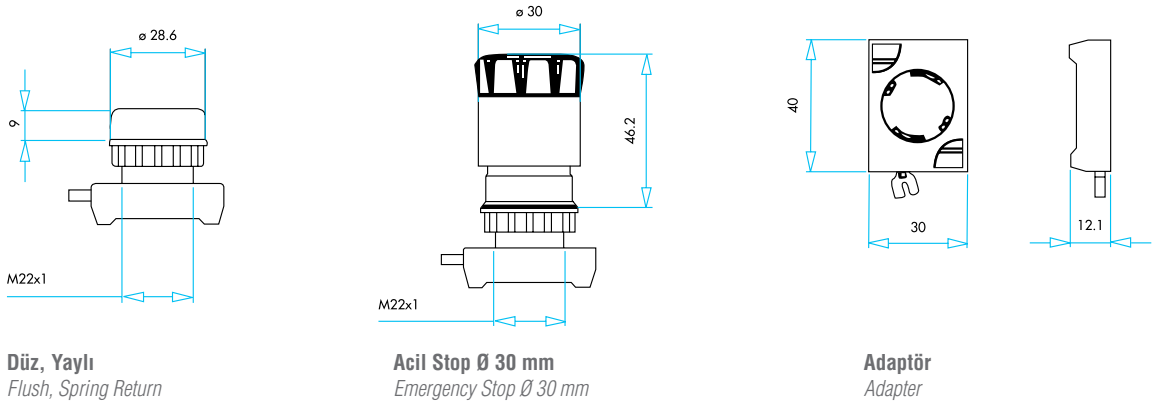





## CP Serisi Plastik Ø 22mm Kumanda Buton Tipleri

- Maksimum güvenlik için parmak koruma
- Darbe dayanıklı polikarbonat buton lensi
- Alev almayan V0 PA6.6 kontak bloklar
- İstenildiğinde çeşitli ışıklı kontak blokların uygunluğu
- Kolaylıkla tek elle adaptörün sökülebilmesi, adaptöre kontak blokların takılmasında alete ihtiyaç olmaması
- Led ışıkla, minimum ısınma maksimum ömür
- Arka arkaya 2 kontak blok takılabilir
- Farklı dillerde ve özel işaretli çeşitli markalama etiketleri
- Üstün silikon conta tekniği ile IP65 koruma
- Tüm uygulamalara cevap verecek ürün çeşitliliği

### Teknik Bilgiler

Mekanik Ömür	: 500.000 açma-kapama min.
Elektriksel Ömür	: 100.000 açma-kapama min.
Çalışma Sıcaklığı	: min./maks. °C -5/+40
Koruma Sınıfı	: IP65
Çalışma Sıklığı	: Yüksüz 3.000 açma-kapama/saat
	: Yükte 1.200 açma-kapama/saat
Çalışma Gerilimi (Ue)	: 230 V AC
Çalışma Akımı (Ie)	: 4 A
Yalıtım Gerilimi (Ui)	: 300 V
Darbe Dayanım Gerilimi (Uimp)	: 2.5 kV
Kısa Devre Kesme Kap. (Icn)	: 1 kA
İzolasyon Direnci	: 10 MΩ min. (500 V DC)
Kullanım Sınıfı	: AC15
Dielektrik Mukavemeti	: 1.500 V AC (1 dk. için)
Standart Kontak Malzemesi	: AgNi
Bağlantı Kablo Kesiti	: 1.5 - 2.5 mm <sup>2</sup>
Standart	: UL 508 TS EN 60947-5-1 VDE0660



## CP Series Plastic Ø 22mm Control Units Types

- Finger safe protection for maximum safety
- Impact-resistant polycarbonate button lens
- Non-flammable V0 PA6.6 contact blocks
- Various illumination contact blocks availability on request
- Easy one-hand adapter removal, tools not required to attach contact blocks to adapter
- With LED illumination, minimum warm-up and maximum lifetime
- Compact design contact blocks can be stacked by 2 blocks deep
- Various legend plates with different languages and custom markings
- IP65 protection degree with superior silicone sealing techniques
- Variety of products for all areas of application

### Technical Information

Mechanical Life	: 500.000 operations min.
Electrical Life	: 100.000 operations min.
Operating Temperature	: min./max. °C -5/+40
Protection Degree	: IP65
Operating Frequency	: Without load 3.000 operations/hour
	: At full load 1.200 operations/hour
Operating Voltage (Ue)	: 230 V AC
Operating Current (Ie)	: 4 A
Insulation Voltage (Ui)	: 300 V
Impact Resistance (Uimp)	: 2.5 kV
Short Circuit Breaking Capacity (Icn)	: 1 kA
Insulation Resistance	: 10 MΩ min. (500 V DC)
Utilization Category	: AC15
Dielectric Strength	: 1.500 V AC (For 1 minute)
Standard Contact Material	: AgNi
Cable Section	: 1.5 - 2.5 mm <sup>2</sup>
Standard	: UL 508 TS EN 60947-5-1 VDE0660



# Kumanda Butonları ve Sinyal Lambaları

## Control Units and Pilot Lights



### CP Plastik Serisi Ø 22mm Kumanda Butonları Genel Şema

CP Plastic Series Ø 22mm Control Units General Scheme

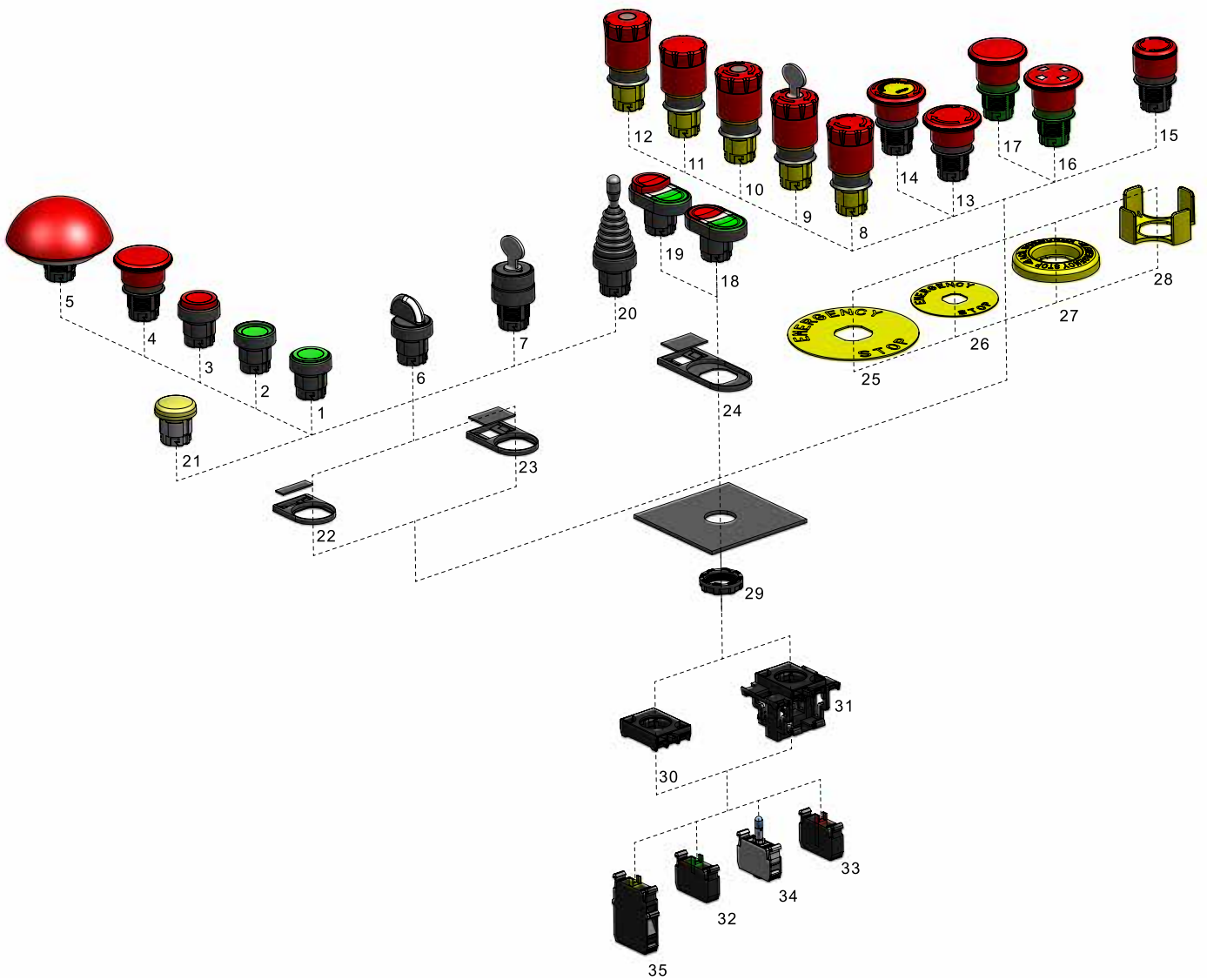

# Kumanda Butonları ve Sinyal Lambaları

## Control Units and Pilot Lights



<b>Yaylı Tip / Spring Type</b>		
1	D	Düz / Flush
2	F	Kalıcı / Stay Put
3	H	Çıkık / Extended
4	M	Mantar, Ø 40 mm / Mushroom, Ø 40 mm
5	M72	Mantar, Ø 72 mm / Mushroom, Ø 72 mm
<b>Seçici Tip / Selector Type</b>		
6	S	60° / 60°
<b>Anahtarlı Tip / Key Operated Type</b>		
7	A	
<b>Acil Stop / Emergency Stop Type</b>		
8	E30	Ø 30mm, Çevirmeli / Ø 30mm, Turn to Release
9	EA30	Ø 30mm, Anahtarlı, Çevirmeli / Ø 30mm, Key Operated, Turn to Release
10	ES30	Ø 30mm, Sinyalli, Çevirmeli / Ø 30mm, With Signal, Turn to Release
11	ECN30	Ø 30mm, Çekmeli / Ø 30mm, Pull to Release
12	ECS30	Ø 30mm, Sinyalli, Çekmeli / Ø 30mm, With Signal, Pull to Release
13	E	Ø 40mm, Çevirmeli / Ø 40mm, Turn to Release
14	EE	Ø 40mm, Etiketli, Çevirmeli / Ø 40mm, With Label, Turn to Release
15	EK30	Ø 30mm, Kısa, Çevirmeli / Ø 30mm, Short, Turn to Release
16	EP	Ø 40mm, Pencere, Çekmeli / Ø 40mm, With Window, Pull to Release
17	EC	Ø 40mm, Çekmeli / Ø 40mm, Pull to Release
<b>Çiftli / Double</b>		
18	K20	Düz Kafalı / Flush
19	K21	1 Çıkık Kafalı / Single Extended
<b>Joystik Tip / Joystick</b>		
20	DJ20	2 Pozisyonlu, Kalıcı / 2 Position, Stay Put
20	DJ21	2 Pozisyonlu, Dönüştü / 2 Position, Spring Return
20	DJ40	4 Pozisyonlu, Kalıcı / 4 Position, Stay Put
20	DJ41	4 Pozisyonlu, Dönüştü / 4 Position, Spring Return
<b>Sinyal / Pilots</b>		
21	X	Yuvarlak, Sinyal / Round, Pilots
<b>Aksesuarlar / Accessories</b>		
22	BROZET08	Rozet, 8mm / Legend Plate Holder, 8mm
23	BROZET18	Rozet, 18mm / Legend Plate Holder, 18mm
24	BCIFTLIROZET18	Rozet, İkiz Buton, 18mm / Legend Plate Holder, Double, 18mm
25	BET90A/P	Etiket, Ø90mm Acil Stop, Alüminyum / Plastik / Legend Plate, Ø90mm Emergency Stop, Aluminium / Plastic
26	BET60A/P	Etiket, Ø60mm Acil Stop, Alüminyum / Plastik / Legend Plate, Ø60mm Emergency Stop, Aluminium / Plastic
27	BET60LED	Etiket, Ø60mm Acil Stop, LED / LED Illuminated Legend Plate, Ø60mm Emergency Stop
28	CMUHAFAZA	Emniyet Koruma / Emergency Protective Cover
29	SOMUN	Plastic Somun, M22 X 1,5 / Plastic Nut, M22 X 1,5
30	ADAPTÖR	Adaptör / Adapter
31	EKLİ ADAPTÖR	Ek Adaptör / Additional Adapter
32	START KONTAKBLOK	Kontakt Blok, Start (NA) / Contact Block, Start (NO)
33	STOP KONTAKBLOK	Kontakt Blok, Stop (NK) / Contact Block, Stop (NC)
34	LED KONTAKBLOK	Kontakt Blok, LED / Contact Block, LED
35	JOYSTIK KONTAKBLOK	Kontakt, Joystik / Contact Block, Joystick

# Kumanda Butonları ve Sinyal Lambaları

## Control Units and Pilot Lights



### CP Serisi Kumanda Butonlar Seçim Tablosu

#### Series Control Units Selection Table

Seri	Kontakt Blok Kombinasyonu			Buton Tipi																																																																																																																																																																
CP	1	K	2	D																																																																																																																																																																
Series	Contact Block Combination			Button Type																																																																																																																																																																
<b>Seri Series</b> <b>CP</b> Plastik Serisi Ø 22mm Kumanda Butonları Plastic Series Ø 22mm Control Units	<b>Kontakt Blok Tipi</b> Contact Block Type	<b>Kontakt Blok Tipi</b> Contact Block Type	<b>Kontakt Blok Tipi</b> Contact Block Type	<b>Acil Stop Tip</b> Emergency Stop Type																																																																																																																																																																
	<table border="1"> <tr><td>0</td><td>Boş</td><td></td><td></td></tr> <tr><td>1</td><td>Start</td><td>Butonluk</td><td>For Button</td></tr> <tr><td>2</td><td>Stop</td><td>Butonluk</td><td>For Button</td></tr> <tr><td>3</td><td>Yanyana</td><td>Start</td><td>Start</td></tr> <tr><td>4</td><td>Yanyana</td><td>Start</td><td>Stop</td></tr> <tr><td>5</td><td>Yanyana</td><td>Stop</td><td>Stop</td></tr> <tr><td>6</td><td>Start</td><td>Start</td><td>Düşey</td></tr> <tr><td>7</td><td>Start</td><td>Stop</td><td>Joystick İçin</td></tr> </table>	0	Boş			1	Start	Butonluk	For Button	2	Stop	Butonluk	For Button	3	Yanyana	Start	Start	4	Yanyana	Start	Stop	5	Yanyana	Stop	Stop	6	Start	Start	Düşey	7	Start	Stop	Joystick İçin	<table border="1"> <tr><td>0</td><td>Boş</td><td></td><td></td></tr> <tr><td>1</td><td>Start</td><td>Butonluk</td><td>For Button</td></tr> <tr><td>2</td><td>Stop</td><td>Butonluk</td><td>For Button</td></tr> <tr><td>3</td><td>Yanyana</td><td>Start</td><td>Start</td></tr> <tr><td>4</td><td>Yanyana</td><td>Start</td><td>Stop</td></tr> <tr><td>5</td><td>Yanyana</td><td>Stop</td><td>Stop</td></tr> <tr><td>6</td><td>Start</td><td>Start</td><td>Düşey</td></tr> <tr><td>7</td><td>Start</td><td>Stop</td><td>Joystick İçin</td></tr> </table>	0	Boş			1	Start	Butonluk	For Button	2	Stop	Butonluk	For Button	3	Yanyana	Start	Start	4	Yanyana	Start	Stop	5	Yanyana	Stop	Stop	6	Start	Start	Düşey	7	Start	Stop	Joystick İçin	<table border="1"> <tr><td>0</td><td>Boş</td><td></td><td></td></tr> <tr><td>1</td><td>Start</td><td>Butonluk</td><td>For Button</td></tr> <tr><td>2</td><td>Stop</td><td>Butonluk</td><td>For Button</td></tr> <tr><td>3</td><td>Yanyana</td><td>Start</td><td>Start</td></tr> <tr><td>4</td><td>Yanyana</td><td>Start</td><td>Stop</td></tr> <tr><td>5</td><td>Yanyana</td><td>Stop</td><td>Stop</td></tr> <tr><td>6</td><td>Start</td><td>Start</td><td>Düşey</td></tr> <tr><td>7</td><td>Start</td><td>Stop</td><td>Joystick İçin</td></tr> </table>	0	Boş			1	Start	Butonluk	For Button	2	Stop	Butonluk	For Button	3	Yanyana	Start	Start	4	Yanyana	Start	Stop	5	Yanyana	Stop	Stop	6	Start	Start	Düşey	7	Start	Stop	Joystick İçin	<table border="1"> <tr><td>0</td><td>Boş</td><td></td><td></td></tr> <tr><td>5</td><td>12 - 30V AC/DC</td><td>Beyaz LED'li</td><td>With White LED</td></tr> <tr><td>6</td><td>12 - 30V AC/DC</td><td>Kırmızı LED'li</td><td>With Red LED</td></tr> <tr><td>7</td><td>12 - 30V AC/DC</td><td>Mavi LED'li</td><td>With Blue LED</td></tr> <tr><td>8</td><td>12 - 30V AC/DC</td><td>Sarı LED'li</td><td>With Yellow LED</td></tr> <tr><td>9</td><td>12 - 30V AC/DC</td><td>Yeşil LED'li</td><td>With Green LED</td></tr> <tr><td>B</td><td>100 - 230V AC</td><td>Beyaz LED'li</td><td>With White LED</td></tr> <tr><td>K</td><td>100 - 230V AC</td><td>Kırmızı LED'li</td><td>With Red LED</td></tr> <tr><td>M</td><td>100 - 230V AC</td><td>Mavi LED'li</td><td>With Blue LED</td></tr> <tr><td>S</td><td>100 - 230V AC</td><td>Sarı LED'li</td><td>With Yellow LED</td></tr> <tr><td>Y</td><td>100 - 230V AC</td><td>Yeşil LED'li</td><td>With Green LED</td></tr> <tr><td>Q</td><td>Özel Gerilim</td><td>Beyaz LED'li</td><td>With White LED</td></tr> <tr><td>X</td><td>Özel Gerilim</td><td>Kırmızı LED'li</td><td>With Red LED</td></tr> <tr><td>V</td><td>Özel Gerilim</td><td>Mavi LED'li</td><td>With Blue LED</td></tr> <tr><td>W</td><td>Özel Gerilim</td><td>Sarı LED'li</td><td>With Yellow LED</td></tr> <tr><td>Z</td><td>Özel Gerilim</td><td>Yeşil LED'li</td><td>With Green LED</td></tr> </table>	0	Boş			5	12 - 30V AC/DC	Beyaz LED'li	With White LED	6	12 - 30V AC/DC	Kırmızı LED'li	With Red LED	7	12 - 30V AC/DC	Mavi LED'li	With Blue LED	8	12 - 30V AC/DC	Sarı LED'li	With Yellow LED	9	12 - 30V AC/DC	Yeşil LED'li	With Green LED	B	100 - 230V AC	Beyaz LED'li	With White LED	K	100 - 230V AC	Kırmızı LED'li	With Red LED	M	100 - 230V AC	Mavi LED'li	With Blue LED	S	100 - 230V AC	Sarı LED'li	With Yellow LED	Y	100 - 230V AC	Yeşil LED'li	With Green LED	Q	Özel Gerilim	Beyaz LED'li	With White LED	X	Özel Gerilim	Kırmızı LED'li	With Red LED	V	Özel Gerilim	Mavi LED'li	With Blue LED	W	Özel Gerilim	Sarı LED'li	With Yellow LED	Z	Özel Gerilim	Yeşil LED'li	With Green LED
0	Boş																																																																																																																																																																			
1	Start	Butonluk	For Button																																																																																																																																																																	
2	Stop	Butonluk	For Button																																																																																																																																																																	
3	Yanyana	Start	Start																																																																																																																																																																	
4	Yanyana	Start	Stop																																																																																																																																																																	
5	Yanyana	Stop	Stop																																																																																																																																																																	
6	Start	Start	Düşey																																																																																																																																																																	
7	Start	Stop	Joystick İçin																																																																																																																																																																	
0	Boş																																																																																																																																																																			
1	Start	Butonluk	For Button																																																																																																																																																																	
2	Stop	Butonluk	For Button																																																																																																																																																																	
3	Yanyana	Start	Start																																																																																																																																																																	
4	Yanyana	Start	Stop																																																																																																																																																																	
5	Yanyana	Stop	Stop																																																																																																																																																																	
6	Start	Start	Düşey																																																																																																																																																																	
7	Start	Stop	Joystick İçin																																																																																																																																																																	
0	Boş																																																																																																																																																																			
1	Start	Butonluk	For Button																																																																																																																																																																	
2	Stop	Butonluk	For Button																																																																																																																																																																	
3	Yanyana	Start	Start																																																																																																																																																																	
4	Yanyana	Start	Stop																																																																																																																																																																	
5	Yanyana	Stop	Stop																																																																																																																																																																	
6	Start	Start	Düşey																																																																																																																																																																	
7	Start	Stop	Joystick İçin																																																																																																																																																																	
0	Boş																																																																																																																																																																			
5	12 - 30V AC/DC	Beyaz LED'li	With White LED																																																																																																																																																																	
6	12 - 30V AC/DC	Kırmızı LED'li	With Red LED																																																																																																																																																																	
7	12 - 30V AC/DC	Mavi LED'li	With Blue LED																																																																																																																																																																	
8	12 - 30V AC/DC	Sarı LED'li	With Yellow LED																																																																																																																																																																	
9	12 - 30V AC/DC	Yeşil LED'li	With Green LED																																																																																																																																																																	
B	100 - 230V AC	Beyaz LED'li	With White LED																																																																																																																																																																	
K	100 - 230V AC	Kırmızı LED'li	With Red LED																																																																																																																																																																	
M	100 - 230V AC	Mavi LED'li	With Blue LED																																																																																																																																																																	
S	100 - 230V AC	Sarı LED'li	With Yellow LED																																																																																																																																																																	
Y	100 - 230V AC	Yeşil LED'li	With Green LED																																																																																																																																																																	
Q	Özel Gerilim	Beyaz LED'li	With White LED																																																																																																																																																																	
X	Özel Gerilim	Kırmızı LED'li	With Red LED																																																																																																																																																																	
V	Özel Gerilim	Mavi LED'li	With Blue LED																																																																																																																																																																	
W	Özel Gerilim	Sarı LED'li	With Yellow LED																																																																																																																																																																	
Z	Özel Gerilim	Yeşil LED'li	With Green LED																																																																																																																																																																	
	<b>İşık Bloğu Tipi</b> Illumination Block Type			<b>Çiftli Tip</b> Double Type																																																																																																																																																																
				<table border="1"> <tr><td>E</td><td>Ø 40mm</td><td></td><td></td></tr> <tr><td>E30</td><td>Ø 30mm</td><td></td><td></td></tr> <tr><td>EA30</td><td>Ø 30mm</td><td>Anahtarlı</td><td>Key Operated</td></tr> <tr><td>ECN30</td><td>Ø 30mm</td><td></td><td></td></tr> <tr><td>ECS30</td><td>Ø 30mm</td><td>Sinyalli</td><td>With Signal</td></tr> <tr><td>EE</td><td>Ø 40mm</td><td>Etiketli</td><td>With Label</td></tr> <tr><td>EK30</td><td>Ø 30mm</td><td>Kısa</td><td>Short</td></tr> <tr><td>EP</td><td>Ø 40mm</td><td>Pencereli</td><td>With Window</td></tr> <tr><td>ES30</td><td>Ø 30mm</td><td>Sinyalli</td><td>With Signal</td></tr> <tr><td>EC</td><td>Ø 40mm</td><td></td><td></td></tr> </table>	E	Ø 40mm			E30	Ø 30mm			EA30	Ø 30mm	Anahtarlı	Key Operated	ECN30	Ø 30mm			ECS30	Ø 30mm	Sinyalli	With Signal	EE	Ø 40mm	Etiketli	With Label	EK30	Ø 30mm	Kısa	Short	EP	Ø 40mm	Pencereli	With Window	ES30	Ø 30mm	Sinyalli	With Signal	EC	Ø 40mm																																																																																																																										
E	Ø 40mm																																																																																																																																																																			
E30	Ø 30mm																																																																																																																																																																			
EA30	Ø 30mm	Anahtarlı	Key Operated																																																																																																																																																																	
ECN30	Ø 30mm																																																																																																																																																																			
ECS30	Ø 30mm	Sinyalli	With Signal																																																																																																																																																																	
EE	Ø 40mm	Etiketli	With Label																																																																																																																																																																	
EK30	Ø 30mm	Kısa	Short																																																																																																																																																																	
EP	Ø 40mm	Pencereli	With Window																																																																																																																																																																	
ES30	Ø 30mm	Sinyalli	With Signal																																																																																																																																																																	
EC	Ø 40mm																																																																																																																																																																			
				<b>Joystick Tip</b> Joystick Type																																																																																																																																																																
				<table border="1"> <tr><td>K20</td><td>Düz Kafalı</td><td></td><td></td></tr> <tr><td>K21</td><td>1 Çıkık Kafalı</td><td></td><td></td></tr> </table>	K20	Düz Kafalı			K21	1 Çıkık Kafalı																																																																																																																																																										
K20	Düz Kafalı																																																																																																																																																																			
K21	1 Çıkık Kafalı																																																																																																																																																																			
				<table border="1"> <tr><td>DJ20</td><td>2 Pozisyonlu</td><td>Kalıcı</td><td>Stay Put</td></tr> <tr><td>DJ21</td><td>2 Pozisyonlu</td><td>Dönüşlü</td><td>Spring Return</td></tr> <tr><td>DJ40</td><td>4 Pozisyonlu</td><td>Kalıcı</td><td>Stay Put</td></tr> <tr><td>DJ41</td><td>4 Pozisyonlu</td><td>Dönüşlü</td><td>Spring Return</td></tr> </table>	DJ20	2 Pozisyonlu	Kalıcı	Stay Put	DJ21	2 Pozisyonlu	Dönüşlü	Spring Return	DJ40	4 Pozisyonlu	Kalıcı	Stay Put	DJ41	4 Pozisyonlu	Dönüşlü	Spring Return																																																																																																																																																
DJ20	2 Pozisyonlu	Kalıcı	Stay Put																																																																																																																																																																	
DJ21	2 Pozisyonlu	Dönüşlü	Spring Return																																																																																																																																																																	
DJ40	4 Pozisyonlu	Kalıcı	Stay Put																																																																																																																																																																	
DJ41	4 Pozisyonlu	Dönüşlü	Spring Return																																																																																																																																																																	
				<b>Sinyal</b> Pilot Lights																																																																																																																																																																
				<table border="1"> <tr><td>X</td><td>Sinyal</td><td></td><td></td></tr> </table>	X	Sinyal																																																																																																																																																														
X	Sinyal																																																																																																																																																																			

# Kumanda Butonları ve Sinyal Lambaları

## Control Units and Pilot Lights



Renk



Colour

Yazı



Pad Printing

### Buton Tipi

Button Type

### Yaylı Tip

Spring Type

<b>D</b>	Düz Flush
<b>F</b>	Kalıcı Stay Put
<b>H</b>	Çıkık Extended
<b>M</b>	Mantar Ø 40 mm Mushroom Ø 40 mm
<b>M72</b>	Mantar Ø 72 mm Mushroom Ø 72 mm

### Seçici Tip

Selector Type

<b>S20</b>	2 Pozisyonlu 2 Position	Kalıcı Stay Put	(0-I) 60°	60°	↙
<b>S21</b>	2 Pozisyonlu 2 Position	Dönüşlü Spring Return	(0-I) 60°	60°	↖
<b>S30</b>	3 Pozisyonlu 3 Position	Kalıcı Stay Put	(II-0-I) 60°	60°	↘
<b>S31</b>	3 Pozisyonlu 3 Position	Tek Dönüşlü Single Spring Return	(II-0-I) 60°	60°	↙
<b>S32</b>	3 Pozisyonlu 3 Position	Çift Dönüşlü Double Spring Return	(II-0-I) 60°	60°	↖↘

### Anahtarlı Tip

Key Operated Type

<b>AA20</b>	2 Pozisyonlu 2 Position	0 Pozisyonunda Anahtar Çıkan Key Removal at 0 position	Kalıcı Stay Put	(0-I) 60°	60°	↙
<b>AA21</b>	2 Pozisyonlu 2 Position	0 Pozisyonunda Anahtar Çıkan Key Removal at 0 position	Dönüşlü Spring Return	(0-I) 60°	60°	↖
<b>AA30</b>	3 Pozisyonlu 3 Position	0 Pozisyonunda Anahtar Çıkan Key Removal at 0 position	Kalıcı Stay Put	(II-0-I) 60°	60°	↘
<b>AA31</b>	3 Pozisyonlu 3 Position	0 Pozisyonunda Anahtar Çıkan Key Removal at 0 position	Tek Dönüşlü Single Spring Return	(II-0-I) 60°	60°	↙
<b>AA32</b>	3 Pozisyonlu 3 Position	0 Pozisyonunda Anahtar Çıkan Key Removal at 0 position	Çift Dönüşlü Double Spring Return	(II-0-I) 60°	60°	↖↘
<b>AC20</b>	2 Pozisyonlu 2 Position	Tüm Pozisyonlarda Anahtar Çıkan Key Removal at all positions	Kalıcı Stay Put	(0-I) 60°	60°	↙
<b>AC30</b>	3 Pozisyonlu 3 Position	Tüm Pozisyonlarda Anahtar Çıkan Key Removal at all positions	Kalıcı Stay Put	(II-0-I) 60°	60°	↘
<b>AC31</b>	3 Pozisyonlu 3 Position	Tüm Pozisyonlarda Anahtar Çıkan Key Removal at all positions	Tek Dönüşlü Single Spring Return	(II-0-I) 60°	60°	↙
<b>AC32</b>	3 Pozisyonlu 3 Position	Tüm Pozisyonlarda Anahtar Çıkan Key Removal at all positions	Çift Dönüşlü Double Spring Return	(II-0-I) 60°	60°	↖↘

<b>B</b>	Beyaz White	
<b>K</b>	Kırmızı Red	
<b>M</b>	Mavi Blue	
<b>S</b>	Sarı Yellow	
<b>Y</b>	Yeşil Green	
<b>H</b>	Siyah Mat Black Mat	
<b>BB</b>	Beyaz White	Beyaz White
<b>HB</b>	Siyah Black	Beyaz White Mat
<b>HH</b>	Siyah Black	Siyah Black
<b>KY</b>	Kırmızı Red	Yeşil Green
<b>SS</b>	Sarı Yellow	Sarı Yellow
<b>YY</b>	Yeşil Green	Yeşil Green

<b>0</b>	0	Yazılı Printed
<b>10</b>	I-0	Yazılı Printed
<b>1</b>	I	Yazılı Printed
<b>2</b>	II	Yazılı Printed
<b>12</b>	I-II	Yazılı Printed
<b>L</b>	LIGHT	Yazılı Printed
<b>OD</b>	OK	Dikey Yazılı Vertical Arrow
<b>OY</b>	OK	Yatay Yazılı Horizontal Arrow
<b>OK</b>	OK	Özel Yazılı Printed
<b>OO</b>	OK	Özel Yazılı Printed
<b>S</b>	Siren İşareti Siren Symbol	Printed
<b>Z</b>	Zil İşareti Bell Symbol	Printed

**Örnek:** CP1K2DK → Örnek olarak CP plastik serisi, start-stop, 100-230 V AC/DC kırmızı ledli, kırmızı renkli, düz, buton seçilmiştir.

**Example:** CP1K2DK → CP series, start-stop, 100-230 V AC/DC with red LED, red, Flush button has been selected.

# Kumanda Butonları ve Sinyal Lambaları

## Control Units and Pilot Lights



### CP Plastik Ø 22 mm Kumanda Buton Tipleri

#### Plastic Ø 22 mm Control Units Types

#### Yaylı Tip Kumanda Butonlar / Spring Type Control Units

Ürün Kodu	Kontakt Blok Tipi		Işık	Buton Tipi	Renk
Code	Contact Block Type		Illumination	Button Type	Colour
	Normal Açık Normally Open	Normal Kapalı Normally Closed	Opsiyonel Optional		
CP100D*	1	-	√	Düz / Flush	
CP101D*	2	-	√	Düz / Flush	
CP102D*	1	1	√	Düz / Flush	
CP200D*	-	1	√	Düz / Flush	
CP202D*	-	2	√	Düz / Flush	
CP303D*	4	-	√	Düz / Flush	
CP305D*	2	2	√	Düz / Flush	
CP100F*	1	-	√	Kalıcı / Stay Put	
CP101F*	2	-	√	Kalıcı / Stay Put	
CP102F*	1	1	√	Kalıcı / Stay Put	
CP200F*	-	1	√	Kalıcı / Stay Put	
CP202F*	-	2	√	Kalıcı / Stay Put	
CP101H*	1	1	√	Çıkık / Extended	
CP102H*	1	1	√	Çıkık / Extended	
CP200H*	-	1	√	Çıkık / Extended	
CP202H*	-	2	√	Çıkık / Extended	
CP100M*	1	-	-	Mantar / Mushroom	
CP101M*	2	-	-	Mantar / Mushroom	
CP102M*	1	1	-	Mantar / Mushroom	
CP200M*	-	1	-	Mantar / Mushroom	
CP202M*	-	2	-	Mantar / Mushroom	
CP100M72*	1	-	-	Mantar Ø 72 mm / Mushroom Ø 72 mm	
CP200M72*	-	1	-	Mantar Ø 72 mm / Mushroom Ø 72 mm	

• (\*) yerine istenen rengin harfi eklenir.

• Please choose the colour and replace (\*) with the letter.

• Işık Bloğu seçenekleri için bakınız sayfa 36 Kumanda Butonları Seçim Tablosu.

• See page 36 Control Units Selection table for illumination block types.



CP200DK



CP100HK

# Kumanda Butonları ve Sinyal Lambaları

## Control Units and Pilot Lights



### Seçici Tip Kumanda Butonları / Selector Type Control Units

Ürün Kodu	Kontakt Blok Tipi	Işık	Etiket	Buton Tipi	Pozisyon	Renk	
Code	Contact Block Type	Illumination	Button Plates	Button Type	Position	Colour	
	 Normal Açık Normally Open	 Normal Kapalı Normally Closed	LED LED				
CP100S20	1	-	√	0-I	Seçici / Selector	2 Pozisyonlu-Kalıcı-60° / 2 Position-Stay Put-60°	H
CP101S20	2	-	√	0-I	Seçici / Selector	2 Pozisyonlu-Kalıcı-60° / 2 Position-Stay Put-60°	H
CP102S20	1	1	√	0-I	Seçici / Selector	2 Pozisyonlu-Kalıcı-60° / 2 Position-Stay Put-60°	H
CP100S21	1	-	√	0-I	Seçici / Selector	2 Pozisyonlu-Kalıcı-60° / 2 Position-Stay Put-60°	H
CP101S21	2	-	√	0-I	Seçici / Selector	2 Pozisyonlu-Kalıcı-60° / 2 Position-Stay Put-60°	H
CP102S21	1	1	√	0-I	Seçici / Selector	2 Pozisyonlu-Kalıcı-60° / 2 Position-Stay Put-60°	H
CP101S30	2	-	√	II-0-I	Seçici / Selector	3 Pozisyonlu-Kalıcı-60° / 3 Position-Stay Put-60°	H
CP102S30	1	1	√	II-0-I	Seçici / Selector	3 Pozisyonlu-Kalıcı-60° / 3 Position-Stay Put-60°	H
CP101S31	2	-	√	II-0-I	Seçici / Selector	3 Pozisyonlu-Tek Dönüşlü-60° / 3 Position-Single Spring Return-60°	H
CP102S31	1	1	√	II-0-I	Seçici / Selector	3 Pozisyonlu-Tek Dönüşlü-60° / 3 Position-Single Spring Return-60°	H
CP101S32	2	-	√	II-0-I	Seçici / Selector	3 Pozisyonlu-Çift Dönüşlü -60° / 3 Position-Double Spring Return-60°	H
CP102S32	1	1	√	II-0-I	Seçici / Selector	3 Pozisyonlu-Çift Dönüşlü -60° / 3 Position-Double Spring Return-60°	H
CP303S30	4	-	√	II-0-I	Seçici / Selector	3 Pozisyonlu-Kalıcı-60° / 3 Position-Stay Put-60°	H
CP305S30	2	2	√	II-0-I	Seçici / Selector	3 Pozisyonlu-Kalıcı-60° / 3 Position-Stay Put-60°	H

- Işık Bloğu seçenekleri için bakınız sayfa 36 Kumanda Butonları Seçim Tablosu.
- See page 36 Control Units Selection table for illumination block types.



CP100S20

# Kumanda Butonları ve Sinyal Lambaları

## Control Units and Pilot Lights



### CP Plastik Ø 22 mm Kumanda Buton Tipleri

Plastic Ø 22 mm Control Units Types

#### Anahtarlı Tip Kumanda Butonları / Key Operated Type Control Units

Ürün Kodu	Etiket	Tip	Pozisyon	Anahtar Çıkma Pozisyonu
Code	Button Plates	Type	Position	Key Removal Position
CP100AA20	(0-I)	Kalıcı / Stay Put	2 Pozisyonlu / 2 Position	↙ 0
CP101AA20	(0-I)	Kalıcı / Stay Put	2 Pozisyonlu / 2 Position	↙ 0
CP102AA20	(0-I)	Kalıcı / Stay Put	2 Pozisyonlu / 2 Position	↙ 0
CP100AA21	(0-I)	Dönüştü / Spring Return	2 Pozisyonlu / 2 Position	↗ 0
CP101AA21	(0-I)	Dönüştü / Spring Return	2 Pozisyonlu / 2 Position	↗ 0
CP102AA21	(0-I)	Dönüştü / Spring Return	2 Pozisyonlu / 2 Position	↗ 0
CP101AA30	(II-0-I)	Kalıcı / Stay Put	3 Pozisyonlu / 3 Position	↘ 0
CP102AA30	(II-0-I)	Kalıcı / Stay Put	3 Pozisyonlu / 3 Position	↘ 0
CP101AA31	(II-0-I)	Tek Dönüştü / Single Spring Return	3 Pozisyonlu / 3 Position	↘ 0
CP102AA31	(II-0-I)	Tek Dönüştü / Single Spring Return	3 Pozisyonlu / 3 Position	↘ 0
CP101AA32	(II-0-I)	Çift Dönüştü / Double Spring Return	3 Pozisyonlu / 3 Position	↘ 0
CP101AA32	(II-0-I)	Çift Dönüştü / Double Spring Return	3 Pozisyonlu / 3 Position	↘ 0
CP100AC20	(0-I)	Kalıcı / Stay Put	2 Pozisyonlu / 2 Position	↙ Tüm / All
CP101AC20	(0-I)	Kalıcı / Stay Put	2 Pozisyonlu / 2 Position	↙ Tüm / All
CP102AC20	(0-I)	Kalıcı / Stay Put	2 Pozisyonlu / 2 Position	↙ Tüm / All
CP100AC21	(0-I)	Dönüştü / Spring Return	2 Pozisyonlu / 2 Position	↗ Tüm / All
CP101AC21	(0-I)	Dönüştü / Spring Return	2 Pozisyonlu / 2 Position	↗ Tüm / All
CP102AC21	(0-I)	Dönüştü / Spring Return	2 Pozisyonlu / 2 Position	↗ Tüm / All
CP101AC30	(II-0-I)	Kalıcı / Stay Put	3 Pozisyonlu / 3 Position	↘ Tüm / All
CP102AC30	(II-0-I)	Kalıcı / Stay Put	3 Pozisyonlu / 3 Position	↘ Tüm / All
CP101AC31	(II-0-I)	Tek Dönüştü / Single Spring Return	3 Pozisyonlu / 3 Position	↘ Tüm / All
CP102AC31	(II-0-I)	Tek Dönüştü / Single Spring Return	3 Pozisyonlu / 3 Position	↘ Tüm / All
CP101AC32	(II-0-I)	Çift Dönüştü / Double Spring Return	3 Pozisyonlu / 3 Position	↘ Tüm / All
CP101AC32	(II-0-I)	Çift Dönüştü / Double Spring Return	3 Pozisyonlu / 3 Position	↘ Tüm / All



CP100AC20



CP100AA32



# Kumanda Butonları ve Sinyal Lambaları

## Control Units and Pilot Lights



### Acil Stop Tip Kumanda Butonları / Emergency Stop Type Control Units

Ürün Kodu	Kontakt Blok Tipi		Tip	Çap (mm)	Renk
Code	Contact Block Type		Type	Dia (mm)	Colour
					
	Normal Açık Normally Open	Normal Kapalı Normally Closed			
CP100E	1	-	Çevirmeli / Turn to Release	Ø 40mm	 
CP102E	1	1	Çevirmeli / Turn to Release	Ø 40mm	 
CP200E	-	1	Çevirmeli / Turn to Release	Ø 40mm	 
CP202E	-	2	Çevirmeli / Turn to Release	Ø 40mm	 
CP100EE	1	-	Etiketli - Çevirmeli / With Label - Turn to Release	Ø 40mm	
CP102EE	1	1	Etiketli - Çevirmeli / With Label - Turn to Release	Ø 40mm	
CP200EE	-	1	Etiketli - Çevirmeli / With Label - Turn to Release	Ø 40mm	
CP202EE	-	2	Etiketli - Çevirmeli / With Label - Turn to Release	Ø 40mm	
CP100EP	1	-	Pencereli-Çekmeli / With Window-Pull to Release	Ø 40mm	
CP102EP	1	1	Pencereli-Çekmeli / With Window-Pull to Release	Ø 40mm	
CP200EP	-	1	Pencereli-Çekmeli / With Window-Pull to Release	Ø 40mm	
CP202EP	-	2	Pencereli-Çekmeli / With Window-Pull to Release	Ø 40mm	
CP100EK30	1	-	Çevirmeli Kısa / Short, Turn to Release	Ø 30mm	
CP102EK30	1	1	Çevirmeli Kısa / Short, Turn to Release	Ø 30mm	
CP200EK30	-	1	Çevirmeli Kısa / Short, Turn to Release	Ø 30mm	
CP202EK30	-	2	Çevirmeli Kısa / Short, Turn to Release	Ø 30mm	
CP100E30	1	-	Çevirmeli / Turn to Release	Ø 30mm	
CP102E30	1	1	Çevirmeli / Turn to Release	Ø 30mm	
CP200E30	-	1	Çevirmeli / Turn to Release	Ø 30mm	
CP202E30	-	2	Çevirmeli / Turn to Release	Ø 30mm	
CP102ES30	1	1	Sinyalli-Çevirmeli / With Signal-Turn to Release	Ø 30mm	
CP200ES30	-	1	Sinyalli-Çevirmeli / With Signal-Turn to Release	Ø 30mm	
CP102EA30	1	1	Anahtarlı-Çevirmeli / Key Operated-Turn to Release	Ø 30mm	
CP200EA30	-	1	Anahtarlı-Çevirmeli / Key Operated-Turn to Release	Ø 30mm	
CP102EC	1	1	Çekmeli / Pull to Release	Ø 40mm	
CP200EC	-	1	Çekmeli / Pull to Release	Ø 40mm	
CP102ECN30	1	1	Çekmeli / Pull to Release	Ø 30mm	
CP200ECN30	-	1	Çekmeli / Pull to Release	Ø 30mm	
CP102ECS30	1	1	Sinyalli-Çekmeli / With Signal-Pull to Release	Ø 30mm	
CP200ECS30	-	1	Sinyalli-Çekmeli / With Signal-Pull to Release	Ø 30mm	



CP200E



CP200EE



CP200EP



CP200EC



CP200EK30



CP200EA30

# Kumanda Butonları ve Sinyal Lambaları

## Control Units and Pilot Lights



### CP Plastik Ø 22 mm Kumanda Buton Tipleri

#### Plastic Ø 22 mm Control Units Types

#### Çiftli Tip Kumanda Butonları / Double Type Control Units



CP102K20KY

Ürün Kodu	Kontakt Blok Tipi	Işık	Buton Tipi	Renk		
Code	Contact Block Type	Illumination	Control Unit Type	Colour		
	Normal Açık Normally Open	Normal Kapalı Normally Closed	Opsiyonel Optional			
CP102K20HB	1	1	✓	Çiftli / Double	Düz Kafalı / Flush	(B) (H)
CP102K20HS	1	1	✓	Çiftli / Double	Düz Kafalı / Flush	(S) (H)
CP102K20KY	1	1	✓	Çiftli / Double	Düz Kafalı / Flush	(K) (Y)
CP102K21HB	1	1	✓	Çiftli / Double	1 Çıkık Kafalı / Single Extended	(B) (H)
CP102K21KY	1	1	✓	Çiftli / Double	1 Çıkık Kafalı / Single Extended	(K) (Y)

- Işık Bloğu seçenekleri için bakınız sayfa 36 Kumanda Butonları Seçim Tablosu.
- See page 36 Control Units Selection table for illumination block types.
- Standart çiftli buton B102K20KY, kırmızı / yeşil ve şeffaftır.
- Standard double head control unit is B102K20KY which is red/green and transparent.
- • Çiftli butonda sadece kırmızı ve siyah renkli basma düğmeleri çıkıktır.
- • • For double head control unit, only red and black colored buttons are extended position.

#### Joystick Tip Kumanda Butonları / Joystick Type Control Units



CP707DJ40

Ürün Kodu	Kontakt Blok Tipi	Tip	Pozisyon	Renk	
Code	Contact Block Type	Type	Position	Colour	
	Normal Açık Normally Open	Normal Kapalı Normally Closed			
CP101DJ20	2	-	Kalıcı / Stay Put	2 Pozisyonlu / 2 Position	(H)
CP101DJ21	2	-	Dönüşlü / Spring Return	2 Pozisyonlu / 2 Position	(H)
CP102DJ21	1	1	Dönüşlü / Spring Return	2 Pozisyonlu / 2 Position	(H)
CP707DJ40	4	-	Kalıcı / Stay Put	2 Pozisyonlu / 2 Position	(H)
CP707DJ41	4	-	Dönüşlü / Spring Return	2 Pozisyonlu / 2 Position	(H)

#### Sinyaller / Pilot Lights



CP060XK

Ürün Kodu	Işık	Nominal Gerilim	Renk
Code	Illumination	Nominal Voltage	Colour
CP050XB	LED	12 - 30V AC/DC	(B)
CP060XK	LED	12 - 30V AC/DC	(K)
CP070XM	LED	12 - 30V AC/DC	(M)
CP080XS	LED	12 - 30V AC/DC	(S)
CP090XY	LED	12 - 30V AC/DC	(Y)
CP0B0XB	LED	100 - 230V AC	(B)
CP0K0XK	LED	100 - 230V AC	(K)
CP0M0XM	LED	100 - 230V AC	(M)
CP0S0XS	LED	100 - 230V AC	(S)
CP0Y0XY	LED	100 - 230V AC	(Y)

# Kumanda Butonları ve Sinyal Lambaları

## Control Units and Pilot Lights



### Kontakt Blok Tipler / Contact Block Types

Ürün Kodu	Kontakt Blok Tipi	Işık	Nominal Akım	Nominal Gerilim	Kullanım Yeri	Renk
Code	Contact Block Type	Illumination	Nominal Current	Nominal Voltage	Place of Use	Colour
C1	1	-	4A	230V AC	Butonluk / For Control Units	
C1AU			4A	230V AC	Butonluk -Altın Kaplamalı/ For Control Units-Gold Plated	
C2	1	-	4A	230V AC	Butonluk / For Control Units	
C2AU			4A	230V AC	Butonluk -Altın Kaplamalı / For Control Units-Gold Plated	
C12			4A	230V AC	Joystick- Butonluk / Joystick For Control Units	
CB5		LED	5-20mA	12-30V AC/DC	Butonluk / For Control Units	B
CB6		LED	5-20mA	12-30V AC/DC	Butonluk / For Control Units	K
CB7		LED	5-20mA	12-30V AC/DC	Butonluk / For Control Units	M
CB8		LED	5-20mA	12-30V AC/DC	Butonluk / For Control Units	S
CB9		LED	5-20mA	12-30V AC/DC	Butonluk / For Control Units	Y
CBB		LED	5-15mA	100-230V AC	Butonluk / For Control Units	B
CBK		LED	5-15mA	100-230V AC	Butonluk / For Control Units	K
CBM		LED	5-15mA	100-230V AC	Butonluk / For Control Units	M
CBS		LED	5-15mA	100-230V AC	Butonluk / For Control Units	S
CBY		LED	5-15mA	100-230V AC	Butonluk / For Control Units	Y
CBB4		LED	4-5mA	110V AC/DC	Butonluk / For Control Units	B
CBK4		LED	4-5mA	110V AC/DC	Butonluk / For Control Units	K
CBM4		LED	4-5mA	110V AC/DC	Butonluk / For Control Units	M
CBS4		LED	4-5mA	110V AC/DC	Butonluk / For Control Units	S
CBY4		LED	4-5mA	110V AC/DC	Butonluk / For Control Units	Y
C3	1		4A	230V AC	Kutuluk / For Boxes	
C4	1		4A	230V AC	Kutuluk / For Boxes	
C3CK	1		4A	230V AC	C Serisi Butona Uygun Kutuluk / Suitable for C Series Control Unit For Boxes	
C4CK	1		4A	230V AC	C Serisi Butona Uygun Kutuluk / Suitable for C Series Control Unit For Boxes	
C3BK	1		4A	230V AC	B Serisi Butona Uygun Kutuluk / Suitable for B Series Control Unit For Boxes	
C4BK	1		4A	230V AC	B Serisi Butona Uygun Kutuluk / Suitable for B Series Control Unit For Boxes	
CK5		LED	5-20 mA	12-30V AC/DC	Kutuluk / For Boxes	B
CK6		LED	5-20 mA	12-30V AC/DC	Kutuluk / For Boxes	K
CK7		LED	5-20 mA	12-30V AC/DC	Kutuluk / For Boxes	M
CK8		LED	5-20 mA	12-30V AC/DC	Kutuluk / For Boxes	S
CK9		LED	5-20 mA	12-30V AC/DC	Kutuluk / For Boxes	Y
CKB		LED	5-15 mA	100-230V AC/DC	Kutuluk / For Boxes	B
CKK		LED	5-15 mA	100-230V AC/DC	Kutuluk / For Boxes	K
CKM		LED	5-15 mA	100-230V AC/DC	Kutuluk / For Boxes	M
CKS		LED	5-15 mA	100-230V AC/DC	Kutuluk / For Boxes	S
CKY		LED	5-15 mA	100-230V AC/DC	Kutuluk / For Boxes	Y
CKB4		LED	4-5 mA	110V AC/DC	Kutuluk / For Boxes	B
CKK4		LED	4-5 mA	110V AC/DC	Kutuluk / For Boxes	K
CKM4		LED	4-5 mA	110V AC/DC	Kutuluk / For Boxes	M
CKS4		LED	4-5 mA	110V AC/DC	Kutuluk / For Boxes	S
CKY4		LED	4-5 mA	110V AC/DC	Kutuluk / For Boxes	Y

• Maksimum 3 adet kontak blok arka arkaya eklenebilir.

• Max. 3 contact blocks can be added subsequently.

•• C1AU, C2AU Altın kaplamalı kontak blok.

•• C1AU, C2AU gold plated contact block.

••• C12, Joystic kontak blok.

••• C12, Joystick contact block.



C1



C2



C3



C4



CKM

# Kumanda Butonları ve Sinyal Lambaları

## Control Units and Pilot Lights



### CP Plastik Ø 22 mm Kumanda Buton Tipleri

#### Plastic Ø 22 mm Control Units Types

#### Yedekler / Spare Parts

Ürün Kodu	Çap (mm)	Buton Tipi	Pozisyon	Renk
Code	Dia (mm)	Control Unit Types	Position	Colour
CPDD*		Düz / Flush		
CPDF*		Kalıcılı / Stay Put		
CPDH*		Çıkık / Extended		
CPDM*		Mantar / Mushroom		
CPDM72*	Ø 72mm	Mantar / Mushroom		
CPDS20		Seğici / Selector	2 Pozisyonlu-Kalıcı-60° / 2 Position-Stay Put-60°	
CPDS21		Seğici / Selector	2 Pozisyonlu-Dönüslü-60° / 2 Position-Spring Return-60°	
CPDS30		Seğici / Selector	3 Pozisyonlu-Kalıcı -60° / 3 Position-Stay Put-60°	
CPDS31		Seğici / Selector	3 Pozisyonlu-Çift Dönüslü -60° / 3 Position-Double Spring Return-60°	
CPDS32		Seğici / Selector	3 Pozisyonlu-Tek Dönüslü-60° / 3 Position-Single Spring Return-60°	
CPDAA20		Anahtarlı / Key Operated	2 Pozisyonlu- Kalıcı / 2 Position-Stay Put	
CPDAA21		Anahtarlı / Key Operated	2 Pozisyonlu, Dönüslü / 2 Position, Spring Return	
CPDAA30		Anahtarlı / Key Operated	3 Pozisyonlu, Kalıcı / 3 Position, Stay Put	
CPDAA31		Anahtarlı / Key Operated	3 Pozisyonlu, Tek Dönüslü / 3 Position, Single Spring Return	
CPDAA32		Anahtarlı / Key Operated	3 Pozisyonlu, Çift Dönüslü / 3 Position, Double Spring Return	
CPDAC20		Anahtarlı / Key Operated	2 Pozisyonlu, Kalıcı / 2 Position, Stay Put	
CPDAC21		Anahtarlı / Key Operated	2 Pozisyonlu, Dönüslü / 2 Position, Spring Return	
CPDAC30		Anahtarlı / Key Operated	3 Pozisyonlu, Kalıcı / 3 Position, Stay Put	
CPDAC31		Anahtarlı / Key Operated	3 Pozisyonlu-Tek Dönüslü / 3 Position - Single Spring Return	
CPDAC32		Anahtarlı / Key Operated	3 Pozisyonlu -Çift Dönüslü / 3 Position - Double Spring Return	
CPDE		Acil Stop / Emergency Stop	Çevirmeli / Turn to Release	
CPDEE	Ø 40mm	Acil Stop / Emergency Stop	Etikelli - Çevirmeli / With Label - Turn to Release	
CPDEP	Ø 40mm	Acil Stop / Emergency Stop	Pencereli-Çekmeli / With Window-Pull to Release	
CPDEK30	Ø 30mm	Acil Stop / Emergency Stop	Kısa, Çevirmeli / Short, Turn to Release	
CPDE30	Ø 30mm	Acil Stop / Emergency Stop	Çevirmeli / Turn to Release	
CPDES30	Ø 30mm	Acil Stop / Emergency Stop	Sinyalli-Çevirmeli / With Signal-Turn to Release	
CPDEA30	Ø 30mm	Acil Stop / Emergency Stop	Anahtarlı-Çevirmeli / Key Operated-Turn to Release	
CPDEC	Ø 40mm	Acil Stop / Emergency Stop	Çekmeli / Pull to Release	
CPDECN30	Ø 30mm	Acil Stop / Emergency Stop	Çekmeli / Pull to Release	
CPDECS30	Ø 30mm	Acil Stop / Emergency Stop	Sinyalli-Çekmeli / With Signal-Pull to Release	
CPDK20KY		Çiftli / Double	Düz Kafalı / Flush	
CPDK20HB		Çiftli / Double	Düz Kafalı / Flush	
CPDK20HS		Çiftli / Double	Düz Kafalı / Flush	
CPDK21KY		Çiftli / Double	1 Çıkık Kafalı / Single Extended	
CP102K21HB		Çiftli / Double	1 Çıkık Kafalı / Single Extended	
CPDJ20		Joystick	2 Pozisyonlu-Kalıcı / 2 Position-Stay Put	
CPDJ21		Joystick	2 Pozisyonlu-Dönüslü / 2 Position-Spring Return	
CPDJ40		Joystick	4 Pozisyonlu-Kalıcı / 4 Position-Stay Put	
CPDJ41		Joystick	4 Pozisyonlu-Dönüslü / 4 Position-Spring Return	
CPDX*		Sinyal / Pilot Lights	Plastik / Plastic	



CPDY



CPDS20

# Kumanda Butonları ve Sinyal Lambaları

## Control Units and Pilot Lights



### Özel Tampon Baskılı Butonlar / Special Pad Printed Control Units

Ürün Kodu / Code	CP102K20KY-10	CP101K20YY-12	CP101K20YY-OK	CP102K20HB-10	CP101K20HH-OK	CP101K20BB-12	CP101K20SH-10	CP101K20SS-12
Baskı / Print	I-0	I-II	Oklu / Arrow Symbol	I-0	Oklu / Arrow Symbol	I-II	I-0	I-II
Ürün Kodu / Code	CP100DY-0D	CP100DY-0Y	CP100DH-0D	CP100DH-0Y	CP100DB-0D	CP100DB-0Y	CP100DB-Z	CP100DB-L
Baskı / Print	Dikey Oklu Vertical Arrow	Yatay Oklu Horizontal Arrow	Dikey Oklu Vertical Arrow	Yatay Oklu Horizontal Arrow	Dikey Oklu Vertical Arrow	Yatay Oklu Horizontal Arrow	Zil / Bell	Lamba / Lamp
Ürün Kodu / Code	CP100DY-1	CP100DY-2	CP100DB-1	CP100DB-2	CP200DK-0	CP200DH-0	CP200DS-Z	CP200DS-L
Baskı / Print	I	II	I	II	0	0	Zil / Bell	Lamba / Lamp

Not: Minimum Sipariş miktarı 50 Adettir.

Note : Minimum Order Quantity : 50 pcs

### Aksesuarlar / Accessories

Ürün Kodu	Tip	Özellik	Etiket	Malzeme
Code	Types	Features	Button Plates	Material
CA	Adaptör / Adapter			
CA11				
CBUTONORTA	Kontakt Baskı Parçası / Middle Contact Activator			
CEA	Ek Adaptör / Additional Adapter			
CMB				
CMSB				
CMUHAFAZA	Emniyet Koruma / Emergency Protective Cover			
BCIFTLİROZET18	Çiftli Rozet / Double Legend Plate Holder	18mm		
BEB	Etanj Başlık / Silicon Cover	Düz Buton 22mm / Flush Button 22mm		
BEBK20	Etanj Başlık / Silicon Cover	Çiftli Butonlar / Double Buttons		
BEBK21	Etanj Başlık / Silicon Cover	1 Çıkık Kafalı-Çiftli Butonlar Single Extended-Double Buttons		
BMUHAFAZA	Emniyet Koruma / Emergency Protective Cover	Darbe Muhafaza / Stroke Protection		
BPROT	Buton Koruma / Protective Cover	Darbe Muhafaza / Stroke Protection		
BPUL	Pul / Legend Plate	Buton Sıkıştırma / Button Tightening		
BROZET08	Rozet / Legend Plate Holder	8mm		
BROZET18	Rozet / Legend Plate Holder	18mm		
BSOMAN	Somun Anahtarları / Nut Tightener			
BET08	Etiket / Legend Plate	8mm	BOŞ	
BET08-01	Etiket / Legend Plate	8mm	(0-1)	
BET08-01OK	Etiket / Legend Plate	8mm	(0-1) OKLU	
BET08-12	Etiket / Legend Plate	8mm	(I-II)	
BET08-201	Etiket / Legend Plate	8mm	(2-0-1)	

# Kumanda Butonları ve Sinyal Lambaları

## Control Units and Pilot Lights



### CP Plastik Ø 22 mm Kumanda Buton Tipleri

#### Plastic Ø 22 mm Control Units Types

#### Aksesuarlar / Accessories

Ürün Kodu	Tip	Özellik	Etiket	Malzeme
Code	Types	Features	Button Plates	Material
BET08-2010K	Etiket / Legend Plate	8mm	(2-0-1) OKLU	
BET08-2010K2	Etiket / Legend Plate	8mm	(2-0-1) ÇİFT OKLU	
BET08-START	Etiket / Legend Plate	8mm	START	
BET08-STOP	Etiket / Legend Plate	8mm	STOP	
BET18	Etiket / Legend Plate	18mm	BOŞ	
BET18-01	Etiket / Legend Plate	18mm	(0-1)	
BET18-START	Etiket / Legend	18mm	START	
BET48P	Etiket / Legend Plate	48mm	EMERGENCY	Plastik / Plastic
BET60A	Etiket / Legend Plate	60mm	ACİL STOP	Alüminyum / Aluminium
BET60LED1	Etiket-Işıkli-24V AC/DC Plate-With LED-24V AC/DC	60mm	ACİL STOP - EMERGENCY STOP	
BET60LED2	Etiket-Işıkli-24V AC/DC Plate-With LED-24V AC/DC	60mm	EMERGENCY STOP - EMERGENCY STOP	
BET60P	Etiket / Legend Plate	60mm	EMERGENCY STOP	Plastik / Plastic
BET60P1	Etiket / Legend Plate	60mm	ACİL DURDURMA	Plastik / Plastic
BET60P2	Etiket / Legend Plate	60mm	ARRET D'URGENCE	Plastik / Plastic
BET90A	Etiket / Legend Plate	90mm	ACİL STOP	Alüminyum / Aluminium
BET90P	Etiket / Plate	90mm	ACİL STOP	Plastik / Plastic
BET90P-1	Etiket / Plate	90mm	ACİL DURDURMA	Plastik / Plastic

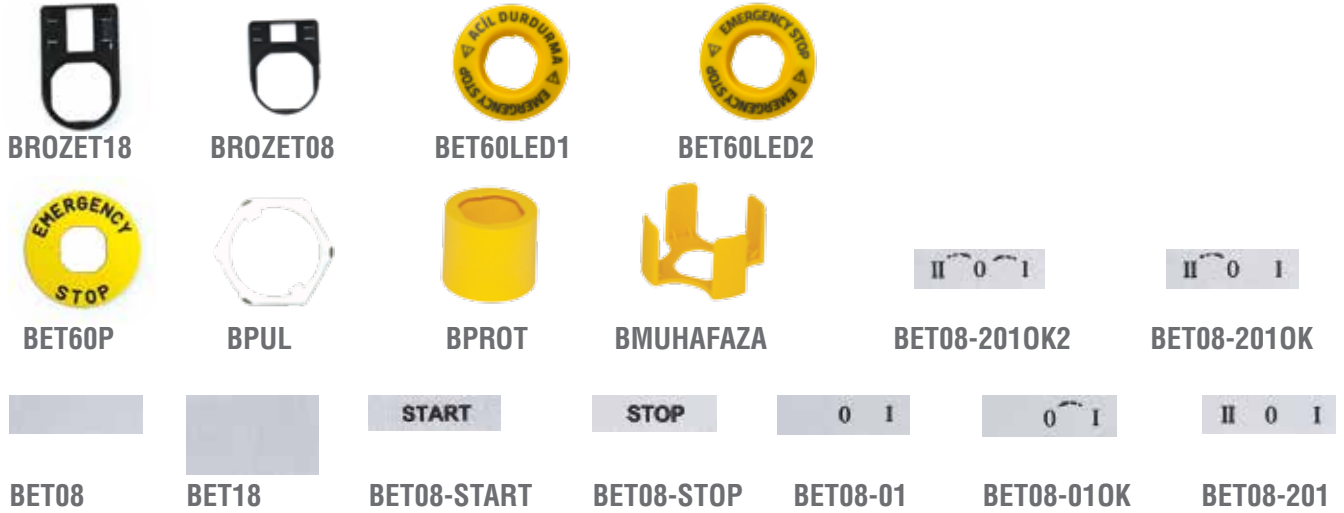

### MONTAJ ŞEKLİ / ASSEMBLY

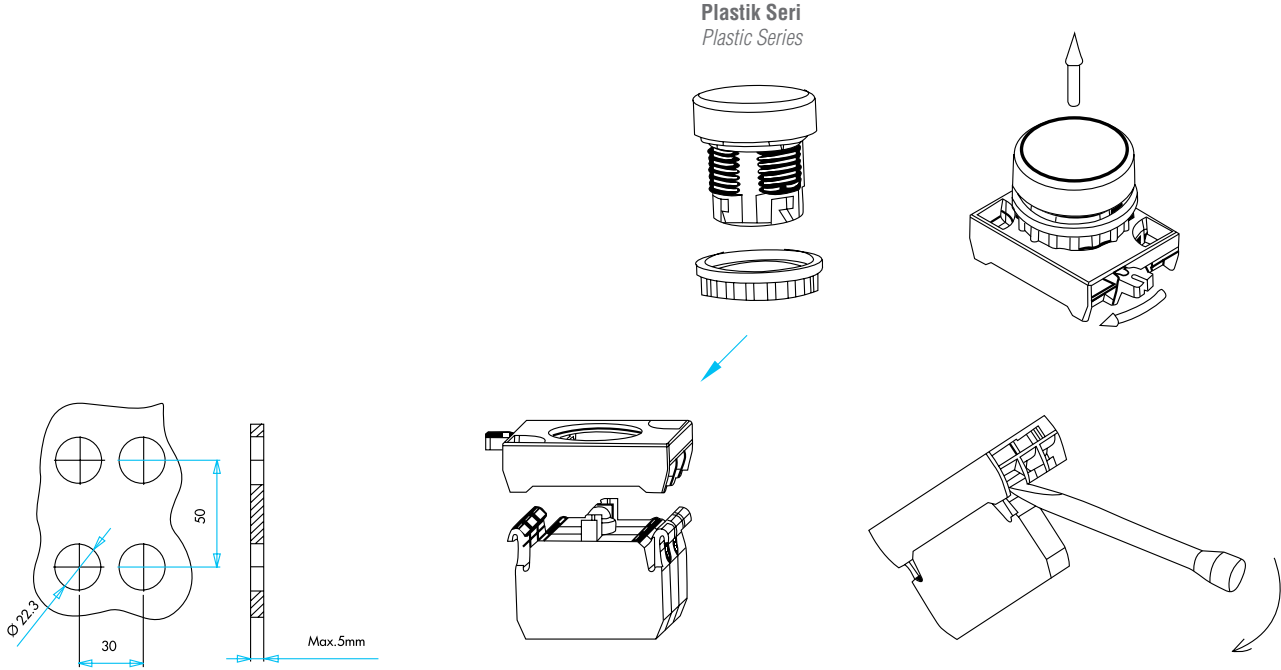

### BOYUTLAR (mm) / DIMENSIONS (mm)

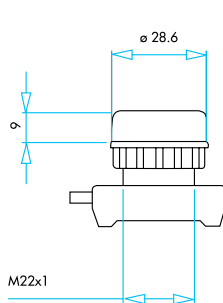

**Düz, Yaylı**  
Flush, Spring Return

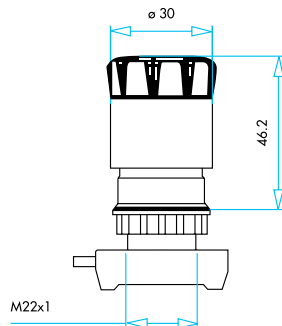

**Acil Stop Ø 30 mm**  
Emergency Stop Ø 30 mm

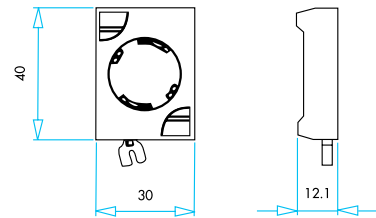

**Adaptör**  
Adapter



## D Serisi Ø 16mm Kumanda Butonları

- Dar alanlarda kullanım kolaylığı
- Darbe dayanıklı polikarbonat buton lensi
- Alev almayan V0 PA6.6 kontak bloklar
- İstenildiğinde çeşitli ışıklı kontak blokların uygunluğu
- Adaptöre kontak blokların takılmasında alete ihtiyaç olmaması
- Led ışıkla, minimum ısınma maksimum ömür
- Tüm uygulamalara cevap verecek ürün çeşitliliği

### Teknik Bilgiler

Mekanik Ömür	: 500.000 açma-kapama min.
Elektriksel Ömür	: 100.000 açma-kapama min.
Çalışma Sıcaklığı	: min./maks. °C -5/+40
Koruma Sınıfı	: IP50
Çalışma Sıklığı	: Yüksüz 3.000 açma-kapama/saat
	: Yükte 1.200 açma-kapama/saat
Çalışma Gerilimi (Ue)	: 250 V AC
Çalışma Akımı (Ie)	: 1,5 A
Yalıtım Gerilimi (Ui)	: 250 V
Darbe Dayanım Gerilimi (Uimp)	: 2,5 kV
Kısa Devre Kesme Kap. (Icn)	: 1 kA
İzolasyon Direnci	: 10 MΩ min. (500 V DC)
Kullanım Sınıfı	: AC15
Dielektrik Mukavemeti	: 1.500 V AC (1 dakika için)
Standart Kontak Malzemesi	: AgNi
Bağlantı Kablo Kesiti	: FASTON 2,8x0,5 mm
Standart	: TS EN 60947-5-1 VDE0660



## D Series Ø 16mm Control Units

- Ease of use in limited spaces
- Impact-resistant polycarbonate button lens
- Non-flammable V0 PA6.6 contact blocks
- Various illumination contact blocks availability on request
- Tools not required to attach contact blocks to adapter
- With LED illumination, minimum warm-up and maximum lifetime
- Variety of products for all areas of application

### Technical Information

Mechanical Life	: 500.000 operations min.
Electrical Life	: 100.000 operations min.
Operating Temperature	: min./max. °C -5/+40
Protection Degree	: IP50
Operating Frequency	: Without load 3.000 operations/hour
	: At full load 1.200 operations/hour
Operating Voltage (Ue)	: 250 V AC
Operating Current (Ie)	: 1,5 A
Insulation Voltage (Ui)	: 250 V
Impact Resistance (Uimp)	: 2,5 kV
Short Circuit Breaking Capacity (Icn)	: 1 kA
Insulation Resistance	: 10 MΩ min. (500 V DC)
Utilization Category	: AC15
Dielectric Strength	: 1.500 V AC (For 1 minute)
Standard Contact Material	: AgNi
Cable Section	: FASTON 2,8x0,5 mm
Standard	: TS EN 60947-5-1 VDE0660





# Kumanda Butonları ve Sinyal Lambaları

## Control Units and Pilot Lights



### D Serisi Ø 16mm Kumanda Butonları Genel Şema

#### D Series Ø 16mm Control Units General Scheme

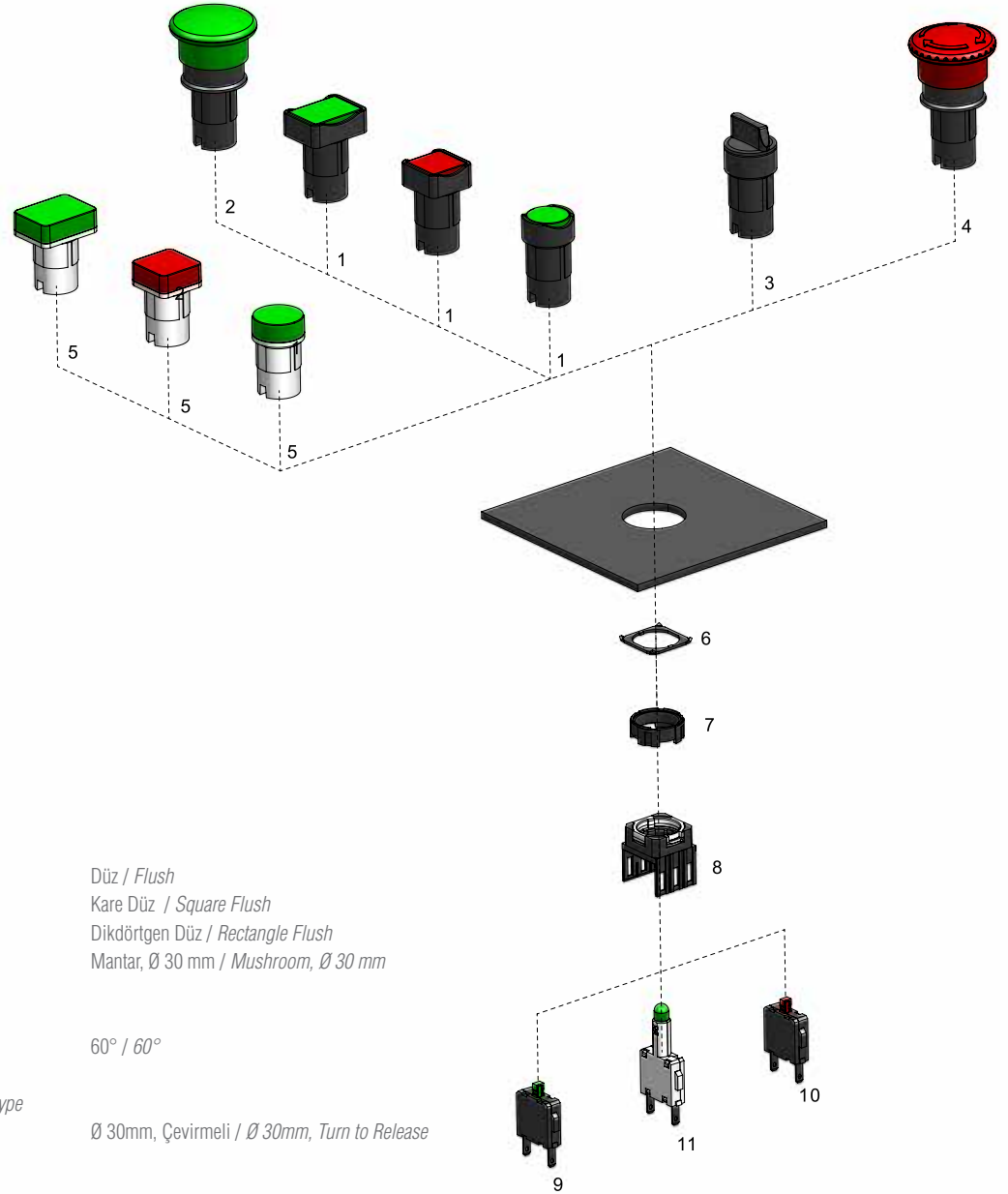

#### Yaylı Tip / Spring Type

- |   |     |                                     |
|---|-----|-------------------------------------|
| 1 | YD  | Düz / Flush                         |
| 1 | KD  | Kare Düz / Square Flush             |
| 1 | DD  | Dikdörtgen Düz / Rectangle Flush    |
| 2 | M30 | Mantar, Ø 30 mm / Mushroom, Ø 30 mm |

#### Seçici Tip / Selector Type

- |   |   |           |
|---|---|-----------|
| 3 | S | 60° / 60° |
|---|---|-----------|

#### Acil Stop / Emergency Stop Type

- |   |     |   |
|---|-----|---|
| 4 | E30 | Ø 30mm, Çevirmeli / Ø 30mm, Turn to Release |
|---|-----|---|

#### Sinyal / Pilots

- |   |    |  |
|---|----|--|
| 5 | KX | D Serisi Ø 16mm, Kare, Sinyal / D Series Ø 16mm, Square, Pilots          |
| 5 | DX | D Serisi Ø 16mm, Dikdörtgen, Sinyal / D Series Ø 16mm, Rectangle, Pilots |
| 5 | YX | D Serisi Ø 16mm, Yuvarlak, Sinyal, / D Series Ø 16mm, Round, Pilots      |

#### Aksesuarlar / Accessories

- |    |                  |  |
|----|------------------|--|
| 6  | DPUL             | Metal Pul / Metal Washer                             |
| 7  | SOMUN            | Plastik Somun / Plastic Nut                          |
| 8  | ADAPTÖR          | Adaptör / Adapter                                    |
| 9  | START KONTAKBLOK | Kontakt Blok, Start (NA) / Contact Block, Start (NO) |
| 10 | STOP KONTAKBLOK  | Kontakt Blok, Stop (NK) / Contact Block, Stop (NC)   |
| 11 | LED KONTAKBLOK   | Kontakt Blok, LED / Contact Block, LED               |

# Kumanda Butonları ve Sinyal Lambaları

## Control Units and Pilot Lights

EMES®

### D Serisi Kumanda Butonlar Seçim Tablosu

Series Control Units Selection Table

Seri	Kontakt Blok Kombinasyonu	Buton Şekli	Buton Tipi	Renk
<b>D</b> Series	<b>1</b> <b>6</b> <b>2</b> Contact Block Combination	<b>D</b> Button Shape	<b>D</b> Button Type	<b>K</b> Colour
<b>Seri</b> Series	<b>Kontakt Blok Tipi</b> Contact Block Type	<b>Buton Şekli</b> Button Shape	<b>Buton Tipi</b> Button Type	<b>Renk</b> Colour
<b>D</b> Serisi Ø 16mm Kumanda Butonu Series Ø 16mm Control Units	<b>0</b> Boş Empty <b>1</b> Start Butonluk Start For Button <b>2</b> Stop Butonluk Stop For Button	<b>0</b> Boş Empty <b>1</b> Start Butonluk Start For Button <b>2</b> Stop Butonluk Stop For Button	<b>Yaylı Tip</b> Spring Type <b>D</b> Düz Flush <b>M30</b> Mantar Ø 30 mm Mushroom Ø 30 mm	<b>K</b> Kırmızı Red
<b>İşık Bloğu Tipi</b> Illumination Block Type	<b>0</b> Boş Without Illumination <b>5</b> 12 - 24V AC/DC Beyaz LED'li 12 - 24V AC/DC With White LED <b>6</b> 12 - 24V AC/DC Kırmızı LED'li 12 - 24V AC/DC With Red LED <b>7</b> 12 - 24V AC/DC Mavi LED'li 12 - 24V AC/DC With Blue LED <b>8</b> 12 - 24V AC/DC Sarı LED'li 12 - 24V AC/DC With Yellow LED <b>9</b> 12 - 24V AC/DC Yeşil LED'li 12 - 24V AC/DC With Green LED	<b>Kontakt Blok Tipi</b> Contact Block Type <b>D</b> Dikdörtgen Rectangle <b>K</b> Kare Square <b>Y</b> Yuvarlak Round	<b>Seçici Tip</b> Selector Type <b>S20</b> 2 Pozisyonlu 2 Position <b>S21</b> 2 Pozisyonlu 2 Position <b>S30</b> 3 Pozisyonlu 3 Position <b>S31</b> 3 Pozisyonlu 3 Position <b>S32</b> 3 Pozisyonlu 3 Position <b>Acil Stop Tip</b> Emergency Stop Type <b>E30</b> Ø 30mm Ø 30mm <b>Sinyal</b> Pilot Lights <b>X</b> Sinyal Pilot Lights	<b>B</b> Beyaz White <b>K</b> Kırmızı Red <b>M</b> Mavi Blue <b>S</b> Sarı Yellow <b>Y</b> Yeşil Green <b>H</b> Siyah Black

**Örnek:** D162DDK → D serisi, start-stop, 12 - 24V AC/DC, kırmızı LED'li, kırmızı renkli, Dikdörtgen, Düz, buton seçilmiştir.



















**Example:** D162DDK → D series, start-stop, 12 - 24V AC/DC, with red LED, Rectangle, Flush button has been selected.

# Kumanda Butonları ve Sinyal Lambaları

## Control Units and Pilot Lights



### Yaylı Tip Kumanda Butonlar / Spring Type Control Units

Ürün Kodu	Kontakt Blok Tipi	Işık	Buton Tipi	Buton Şekli	Renk	
Code	Contact Block Type	Illumination	Button Type	Button Shape	Colour	
	 Normal Açık Normally Open	 Normal Kapalı Normally Closed	Opsiyonel Optional			
D100DD*	1	-	√	Düz / Flush	Dikdörtgen / Rectangle	
D101DD*	2	-	√	Düz / Flush	Dikdörtgen / Rectangle	
D102DD*	1	1	√	Düz / Flush	Dikdörtgen / Rectangle	
D200DD*	-	1	√	Düz / Flush	Dikdörtgen / Rectangle	
D202DD*	-	2	√	Düz / Flush	Dikdörtgen / Rectangle	
D100KD*	1	-	√	Düz / Flush	Kare / Square	
D101KD*	2	-	√	Düz / Flush	Kare / Square	
D102KD*	1	1	√	Düz / Flush	Kare / Square	
D200KD*	-	1	√	Düz / Flush	Kare / Square	
D202KD*	-	2	√	Düz / Flush	Kare / Square	
D100YD*	1	-	√	Düz / Flush	Yuvarlak / Round	
D101YD*	2	-	√	Düz / Flush	Yuvarlak / Round	
D102YD*	1	1	√	Düz / Flush	Yuvarlak / Round	
D200YD*	-	1	√	Düz / Flush	Yuvarlak / Round	
D202YD*	-	2	√	Düz / Flush	Yuvarlak / Round	
D100YM30*	1	-	-	Mantar Ø 30 mm / Mushroom Ø 30 mm	Yuvarlak / Round	
D200YM30*	-	1	-	Mantar Ø 30 mm / Mushroom Ø 30 mm	Yuvarlak / Round	



D100DDY



D200KDK



D200YDK

### Seçici Tip Kumanda Butonları / Selector Type Control Units

Ürün Kodu	Buton Tipi	Pozisyon	Renk
Code	Button Type	Position	Colour
D100YS20	Seçici / Selector	2 Pozisyonlu-Kalıcı-60° / 2 Position-Stay Put-60°	
D100YS21	Seçici / Selector	2 Pozisyonlu-Dönüşlü-60° / 2 Position-Spring Return-60°	
D101YS30	Seçici / Selector	3 Pozisyonlu-Kalıcı-60° / 3 Position-Stay Put-60°	
D101YS31	Seçici / Selector	3 Pozisyonlu-Tek Dönüşlü-60° / 3 Position-Single Spring Return-60°	
D101YS32	Seçici / Selector	3 Pozisyonlu-Çift Dönüşlü-60° / 3 Position-Double Spring Return-60°	



D101YS30

# Kumanda Butonları ve Sinyal Lambaları

## Control Units and Pilot Lights



### D Serisi Ø 16 mm Kumanda Buton Tipleri

Series Ø 16 mm Control Units Types

#### Acil Stop Tip Kumanda Butonları / Emergency Stop Type Control Units

Ürün Kodu	Kontakt Blok Tipi	Etiket	Tip	Çap (mm)	Renk
Code	Contact Block Type	Button Plates	Type	Dia (mm)	Colour
D102YE30*	1	1	Çevirmeli / Turn to Release	Ø 30mm	K
D200YE30*	1	-	Çevirmeli / Turn to Release	Ø 30mm	K



D200YE30

#### Sinyaller / Pilot Lights

Ürün Kodu	Işık	Nominal Gerilim	Buton Şekli	Renk
Code	Illumination	Nominal Voltage	Button Shape	Colour
D050DXB	LED	12 - 24V AC/DC	Dikdörtgen / Rectangle	B
D050KXB	LED	12 - 24V AC/DC	Kare / Square	B
D050YXB	LED	12 - 24V AC/DC	Yuvarlak / Round	B
D060DXK	LED	12 - 24V AC/DC	Dikdörtgen / Rectangle	K
D060KXK	LED	12 - 24V AC/DC	Kare / Square	K
D060YXK	LED	12 - 24V AC/DC	Yuvarlak / Round	K
D070DXM	LED	12 - 24V AC/DC	Dikdörtgen / Rectangle	M
D070KXM	LED	12 - 24V AC/DC	Kare / Square	M
D070YXM	LED	12 - 24V AC/DC	Yuvarlak / Round	M
D080DXS	LED	12 - 24V AC/DC	Dikdörtgen / Rectangle	S
D080KXS	LED	12 - 24V AC/DC	Kare / Square	S
D080YXS	LED	12 - 24V AC/DC	Yuvarlak / Round	S
D090DXY	LED	12 - 24V AC/DC	Dikdörtgen / Rectangle	Y
D090KXY	LED	12 - 24V AC/DC	Kare / Square	Y
D090YXY	LED	12 - 24V AC/DC	Yuvarlak / Round	Y



D060DXK



D080KXS







D070YXM

# Kumanda Butonları ve Sinyal Lambaları

## Control Units and Pilot Lights



### Kontakt Blok Tipler / Contact Block Types

Ürün Kodu Code	Kontakt Blok Tipi Contact Block Type		Işık Illumination	Nominal Gerilim Nominal Voltage	Renk Colour
	 Normal Açık Normally Open	 Normal Kapalı Normally Closed			
D1	1	-	-	240V	-
D2	-	1	-	240V	-
D5	-	-	LED	12 - 24V AC/DC	
D6	-	-	LED	12 - 24V AC/DC	
D7	-	-	LED	12 - 24V AC/DC	
D8	-	-	LED	12 - 24V AC/DC	
D9	-	-	LED	12 - 24V AC/DC	









D9



D2

### Yedekler / Spare Parts

Ürün Kodu Code	Buton Şekli Button Shape	Buton Tipi Control Unit Types	Renk Colour
DDD*	Dikdörtgen / Rectangle	Düz / Flush	
DDK*	Kare / Square	Düz / Flush	
DDX*	Dikdörtgen / Rectangle	Sinyal / Pilot Lights	
DDY*	Yuvarlak / Round	Düz / Flush	
DDYE30K	Yuvarlak / Round	Acil Stop / Emergency Stop	
DDYM30*	Yuvarlak / Round	Mantar / Mushroom	
DKX*	Kare / Square	Sinyal / Pilot Lights	

### Aksesuarlar / Accessories

Ürün Kodu Code	Tip Type
DA	Adaptör / Adapter

### BOYUTLAR (mm) / DIMENSIONS (mm)

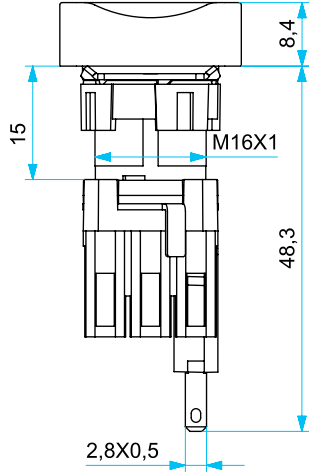

**Dikdörtgen-Kare-Yuvarlak Buton**  
Rectangle-Square-Round Button

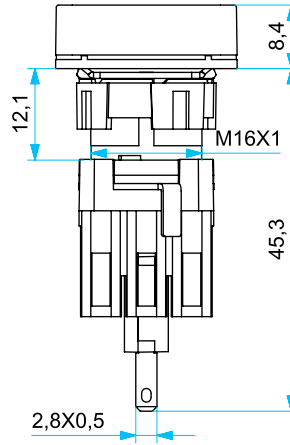

**Dikdörtgen-Kare-Yuvarlak Led Buton**  
Rectangle-Square-Round LED Button

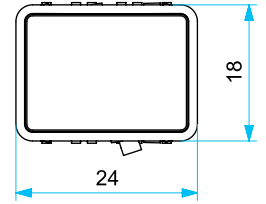

**Dikdörtgen Buton**  
Rectangle Button

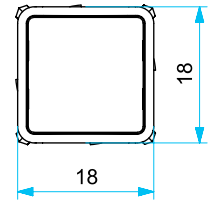

**Kare Buton**  
Square Button

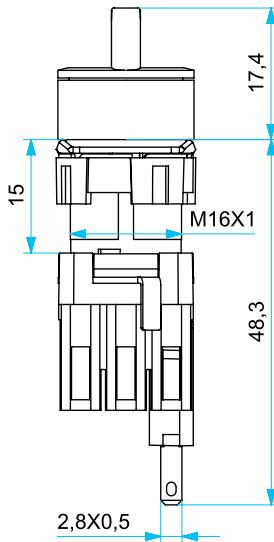
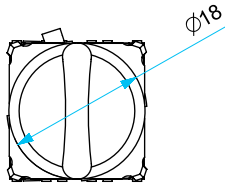

**Seçici Buton**  
Selector Button

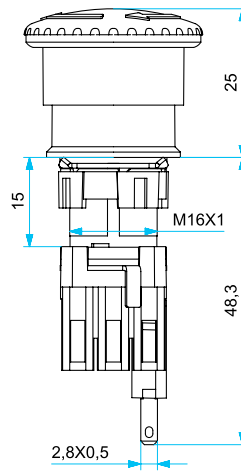
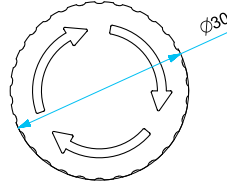

**Emniyet Mantar Buton**  
Emergency Mushroom Button

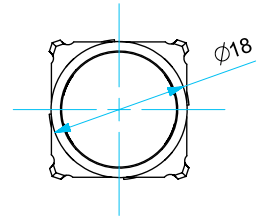

**Yuvarlak Buton**  
Round Button



## H Serisi Ø 30mm Kumanda Butonları

- Darbe dayanıklı polikarbonat buton lensi
- Alev almayan V0 PA6.6 kontak bloklar
- İstenildiğinde çeşitli ışıklı kontak blokların uygunluğu
- Adaptöre kontak blokların takılmasında alete ihtiyaç olmaması
- Led ışıkla, minimum ısınma maksimum ömür
- Arka arkaya 2 kontak blok takılabilir
- Tüm uygulamalara cevap verecek ürün çeşitliliği

### Teknik Bilgiler

Mekanik Ömür	: 500.000 açma-kapama min.
Elektriksel Ömür	: 100.000 açma-kapama min.
Çalışma Sıcaklığı	: min./maks. °C -5/+40
Koruma Sınıfı	: IP50
Çalışma Sıklığı	: Yüzsüz .3000 açma-kapama/saat
	: Yükte 1.200 açma-kapama/saat
Çalışma Gerilimi (Ue)	: 250 V AC
Çalışma Akımı (Ie)	: 4 A
Yalıtım Gerilimi (Ui)	: 300 V
Darbe Dayanım Gerilimi (Uimp)	: 2.5 kV
Kısa Devre Kesme Kap. (Icn)	: 1 kA
İzolasyon Direnci	: 10 MΩ min. (500 V DC)
Kullanım Sınıfı	: AC15
Dielektrik Mukavemeti	: 1.500 V AC (1 dk. için)
Standart Kontak Malzemesi	: AgNi
Bağlantı Kablo Kesiti	: 1.5 - 2.5 mm <sup>2</sup>
Standart	: UL 508 TS EN 60947-5-1 VDE0660



Kontakt Bloklarda

## H Series Ø 30mm Control Units

- Impact-resistant polycarbonate button lens
- Non-flammable V0 PA6.6 contact blocks
- Various illumination contact blocks availability on request
- Tools not required to attach contact blocks to adapter
- With LED illumination, minimum warm-up and maximum lifetime
- Contact blocks can be stacked by two blocks deep
- Variety of products for all areas of application

### Technical Information

Mechanical Life	: 500.000 operations min.
Electrical Life	: 100.000 operations min.
Operating Temperature	: min./max. °C -5/+40
Protection Degree	: IP50
Operating Frequency	: Without load 3000 operations/hour
	: At full load 1200 operations/hour
Operating Voltage (Ue)	: 250 V AC
Operating Current (Ie)	: 4 A
Insulation Voltage (Ui)	: 300 V
Impact Resistance (Uimp)	: 2.5 kV
Short Circuit Breaking Capacity (Icn)	: 1 kA
Insulation Resistance	: 10 MΩ min. (500 V DC)
Utilization Category	: AC15
Dielectric Strength	: 1.500 V AC (For 1 minute)
Standard Contact Material	: AgNi
Cable Section	: 1.5 - 2.5 mm <sup>2</sup>
Standard	: UL 508 TS EN 60947-5-1 VDE0660



Contact Blocks

# Kumanda Butonları ve Sinyal Lambaları Control Units and Pilot Lights



## H Serisi Ø 30mm Kumanda Butonları Genel Şema

H Series Ø 30mm Control Units General Scheme

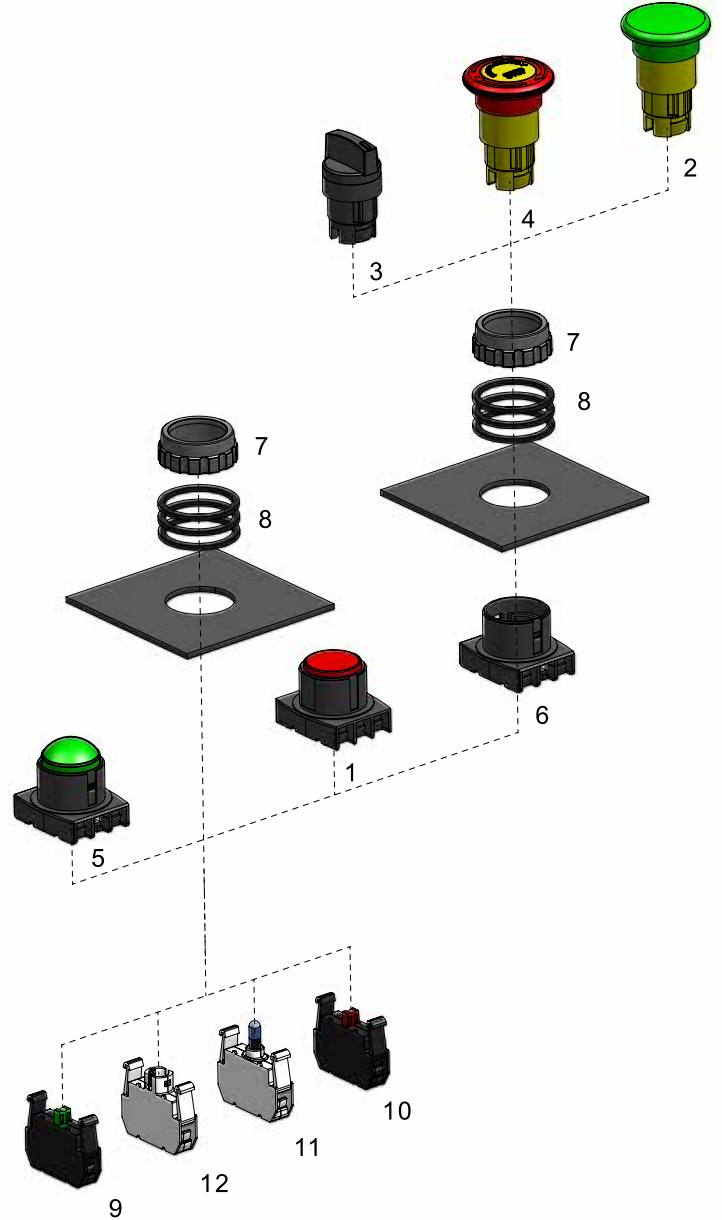

### Yaylı Tip / Spring Type

- 1 D
- 2 M

Düz / Flush  
Mantar, Ø 40 mm  
Mushroom, Ø 40 mm

### Seçici Tip / Selector Type

- 3 S

60° / 60°

### Acil Stop / Emergency Stop Type

- 4 EE

Ø 40mm, Etiketli, Çevirmeli  
Ø 40mm, With Label, Turn to Release

### Sinyal / Pilots

- 5 X

Yuvarlak, Sinyal / Round, Pilots,

### Aksesuarlar / Accessories

- 6 ADAPTÖR
- 7 SOMUN
- 8 CONTA
- 9 START KONTAKBLOK
- 10 STOP KONTAKBLOK
- 11 AMPULLU LED
- 12 LED KONTAKBLOK

Adaptör / Adapter  
Plastik Somun / Plastic Nut  
Mesafe Ayarlama Contası / Spacing Gasket  
Kontakt Blok, Start (NA) / Contact Block, Start (NO)  
Kontakt Blok, Stop (NK) / Contact Block, Stop (NC)  
Ba9S Duyulu Işık Kontakt Blok / Lampholder for Ba9S Bulbs  
Kontakt Blok, LED / Contact Block, LED



# Kumanda Butonları ve Sinyal Lambaları

## Control Units and Pilot Lights



### H Serisi Kumanda Butonlar Seçim Tablosu

#### Series Control Units Selection Table

Seri	Kontakt Blok Kombinasyonu	Buton Tipi	Renk
H	1 K 2	D	K
Series	Contact Block Combination	Button Type	Colour
<b>Seri</b> Series <b>H</b> Serisi Ø 30mm Kumanda Butonu Series Ø 30mm Control Units	<b>Kontakt Blok Tipi</b> Contact Block Type <b>0</b> Boş Empty <b>1</b> Start Butonluk Start For Button <b>2</b> Stop Butonluk Stop For Button	<b>Buton Tipi</b> Button Type <b>Yaylı Tip</b> Spring Type <b>D</b> Düz Flush <b>M</b> Mantar Ø 40 mm Mushroom Ø 40 mm <b>Seçici Tip</b> Selector Type <b>S20</b> 2 Pozisyonlu Kalıcı 2 Position Stay Put (0-1) 60° <b>S21</b> 2 Pozisyonlu Dönüslü 2 Position Spring Return (0-1) 60° <b>S30</b> 3 Pozisyonlu Kalıcı 3 Position Stay Put (II-0-I) 60° <b>S31</b> 3 Pozisyonlu Tek Dönüslü 3 Position Single Spring Return (II-0-I) 60° <b>S32</b> 3 Pozisyonlu Çift Dönüslü 3 Position Double Spring Return (II-0-I) 60° <b>Acil Stop Tip</b> Emergency Stop Type <b>EE</b> Ø 40mm Etiketli Çevirmeli Ø 40mm With Label Turn to Release <b>Sinyal</b> Pilot Lights <b>X</b> Sinyal Pilot Lights	<b>B</b> Beyaz White <b>K</b> Kırmızı Red <b>M</b> Mavi Blue <b>S</b> Sarı Yellow <b>Y</b> Yeşil Green <b>H</b> Siyah Black
<b>Kontakt Blok Tipi</b> Contact Block Type <b>0</b> Boş Empty <b>1</b> Start Butonluk Start For Button <b>2</b> Stop Butonluk Stop For Button	<b>Işık Bloğu Tipi</b> Illumination Block Type <b>0</b> Boş Without Illumination <b>3</b> Işık Blok Ba9S Ampullere Uygun Duylu Illumination Block Suitable for Ba9S Bulbs <b>5</b> 12 - 30V AC/DC Beyaz LED'li 12 - 30V AC/DC With White LED <b>6</b> 12 - 30V AC/DC Kırmızı LED'li 12 - 30V AC/DC With Red LED <b>7</b> 12 - 30V AC/DC Mavi LED'li 12 - 30V AC/DC With Blue LED <b>8</b> 12 - 30V AC/DC Sarı LED'li 12 - 30V AC/DC With Yellow LED <b>9</b> 12 - 30V AC/DC Yeşil LED'li 12 - 30V AC/DC With Green LED <b>B</b> 100 - 230V AC Beyaz LED'li 100 - 230V AC With White LED <b>K</b> 100 - 230V AC Kırmızı LED'li 100 - 230V AC With Red LED <b>M</b> 100 - 230V AC Mavi LED'li 100 - 230V AC With Blue LED <b>S</b> 100 - 230V AC Sarı LED'li 100 - 230V AC With Yellow LED <b>Y</b> 100 - 230V AC Yeşil LED'li 100 - 230V AC With Green LED <b>Q</b> Özel Gerilim Beyaz LED'li Special Voltage With White LED <b>X</b> Özel Gerilim Kırmızı LED'li Special Voltage With Red LED <b>V</b> Özel Gerilim Mavi LED'li Special Voltage With Blue LED <b>W</b> Özel Gerilim Sarı LED'li Special Voltage With Yellow LED <b>Z</b> Özel Gerilim Yeşil LED'li Special Voltage With Green LED	<b>Örnek:</b> H1K2DK → H Serisi, start-stop, 100 - 230V AC, kırmızı LED'li, kırmızı renkli, Düz, buton seçilmiştir. <b>Example:</b> H1K2DK → H Series, start-stop, 100 - 230V AC, with red LED Red, Flush button has been selected.	

# Kumanda Butonları ve Sinyal Lambaları

## Control Units and Pilot Lights



### H Serisi Ø 30 mm Kumanda Buton Tipleri

#### Series Ø 30 mm Control Units Types

#### Yaylı Tip Kumanda Butonlar / Spring Type Control Units

Ürün Kodu	Kontakt Blok Tipi		Işık	Buton Tipi	Renk
Code	Contact Block Type		Illumination	Button Type	Colour
	Normal Açık Normally Open	Normal Kapalı Normally Closed	Opsiyonel Optional		
H100D*	1	-	√	Düz / Flush	
H101D*	2	-	√	Düz / Flush	
H102D*	1	1	√	Düz / Flush	
H200D*	-	1	√	Düz / Flush	
H202D*	-	2	√	Düz / Flush	
H102M*	1	1	-	Mantar / Mushroom	
H200M*	-	1	-	Mantar / Mushroom	
H202M*	-	2	-	Mantar / Mushroom	



H100DY



H200DK

#### Seçici Tip Kumanda Butonları / Selector Type Control Units

Ürün Kodu	Kontakt Blok Tipi		Işık	Etiket	Buton Tipi	Pozisyon	Renk
Code	Contact Block Type		Illumination	Button Plates	Button Type	Position	Colour
	Normal Açık Normally Open	Normal Kapalı Normally Closed	LED LED				
H100S20	1	-	-	0-I	Seçici / Selector	2 Pozisyonlu-Kalıcı-60° / 2 Position-Stay Put-60°	
H101S20	2	-	-	0-I	Seçici / Selector	2 Pozisyonlu-Kalıcı-60° / 2 Position-Stay Put-60°	
H102S20	1	1	-	0-I	Seçici / Selector	2 Pozisyonlu-Kalıcı-60° / 2 Position-Stay Put-60°	
H100S21	1	-	-	0-I	Seçici / Selector	2 Pozisyonlu-Dönüşlü-60° / 2 Position-Spring Return-60°	
H101S21	2	-	-	0-I	Seçici / Selector	2 Pozisyonlu-Dönüşlü-60° / 2 Position-Spring Return-60°	
H102S21	1	1	-	0-I	Seçici / Selector	2 Pozisyonlu-Dönüşlü-60° / 2 Position-Spring Return-60°	
H101S30	2	-	-	II-0-I	Seçici / Selector	3 Pozisyonlu-Kalıcı -60° / 3 Position-Stay Put-60°	
H102S30	1	1	-	II-0-I	Seçici / Selector	3 Pozisyonlu-Kalıcı -60° / 3 Position-Stay Put-60°	
H101S31	2	-	-	II-0-I	Seçici / Selector	3 Pozisyonlu-Tek Dönüşlü-60° / 3 Position-Single Spring Return-60°	
H102S31	1	1	-	II-0-I	Seçici / Selector	4 Pozisyonlu-Tek Dönüşlü-60° / 3 Position-Single Spring Return-60°	
H101S32	2	-	-	II-0-I	Seçici / Selector	3 Pozisyonlu-Çift Dönüşlü -60° / 3 Position-Double Spring Return-60°	
H102S32	1	1	-	II-0-I	Seçici / Selector	3 Pozisyonlu-Çift Dönüşlü-60° / 3 Position-Double Spring Return-60°	

# Kumanda Butonları ve Sinyal Lambaları

## Control Units and Pilot Lights



### Acil Stop Tip Kumanda Butonları / Emergency Stop Type Control Units

Ürün Kodu	Kontakt Blok Tipi	Etiket	Tip	Çap (mm)	Renk
Code	Contact Block Type	Button Plates	Type	Dia (mm)	Colour
H200E	-	1	Çevirmeli / Turn to Release	Ø 40mm	K
H200EE	-	1	Etiketli - Çevirmeli / With Label - Turn to Release	Ø 40mm	K

Normal Açık  
Normally Open

Normal Kapalı  
Normally Closed



H200EE

### Sinyaller / Pilot Lights

Ürün Kodu	Işık	Nominal Gerilim	Renk
Code	Illumination	Nominal Voltage	Colour
H030X*	Ba9S Duyulu		B K M S Y H
H050XB	LED	12 - 30V AC/DC	B
H060XK	LED	12 - 30V AC/DC	K
H070XM	LED	12 - 30V AC/DC	M
H080XS	LED	12 - 30V AC/DC	S
H090XY	LED	12 - 30V AC/DC	Y
H0B0XB	LED	100 - 230V AC	B
H0K0XK	LED	100 - 230V AC	K
H0M0XM	LED	100 - 230V AC	M
H0S0XS	LED	100 - 230V AC	S
H0Y0XY	LED	100 - 230V AC	Y



H060XK



H050XS



H090XY

# Kumanda Butonları ve Sinyal Lambaları

## Control Units and Pilot Lights



### H Serisi Ø 30 mm Kumanda Buton Tipleri

Series Ø 30 mm Control Units Types

#### Kontakt Blok Tipler / Contact Block Types

Ürün Kodu	Kontakt Blok Tipi	Işık	Nominal Akım	Nominal Gerilim	Renk
Code	Contact Block Type	Illumination	Nominal Current	Nominal Voltage	Colour
B1	1	-	4A	250V	-
B2	1	-	4A	250V	-
B3		Ba9S Duyulu	-	-	-
B5		LED	5-20mA	12-30V AC/DC	B
B6		LED	5-20mA	12-30V AC/DC	K
B7		LED	5-20mA	12-30V AC/DC	M
B8		LED	5-20mA	12-30V AC/DC	S
B9		LED	5-20mA	12-30V AC/DC	Y
BB		LED	5-15mA	100-230V AC	B
BK		LED	5-15mA	100-230V AC	K
BM		LED	5-15mA	100-230V AC	M
BS		LED	5-15mA	100-230V AC	S
BY		LED	5-15mA	100-230V AC	Y
BB4		LED	4-5mA	110V AC/DC	B
BK4		LED	4-5mA	110V AC/DC	K
BM4		LED	4-5mA	110V AC/DC	M
BS4		LED	4-5mA	110V AC/DC	S
BY4		LED	4-5mA	110V AC/DC	Y



B1



B2



B3



B9

H100DY

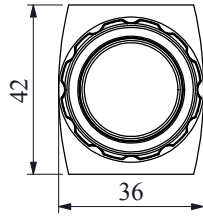
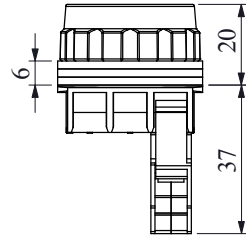

H100S20

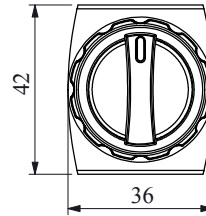
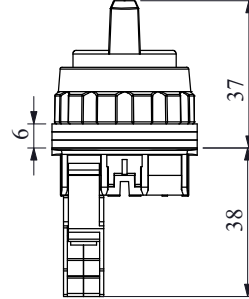

H200EE

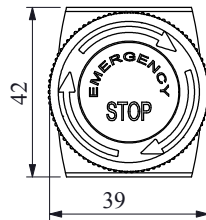
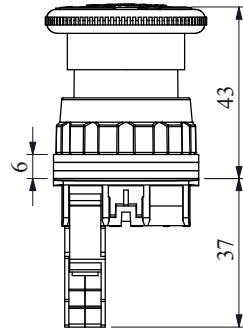

H050XB

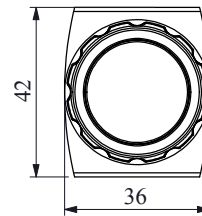
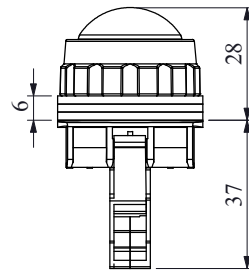

## Montaj Ölçüsü / Mounting Measures

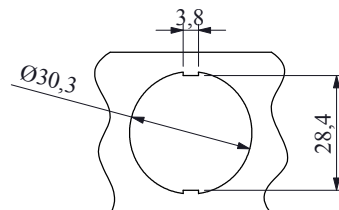



## MB Monoblok Serisi Ø 22mm Kumanda Butonları

- Maksimum güvenlik için parmak koruma
- Darbe dayanıklı polikarbonat buton lensi
- Farklı dillerde ve özel işaretli çeşitli markalama etiketleri
- Tüm uygulamalara cevap verecek ürün çeşitliliği
- Yekpare sağlam gövde

### Teknik Bilgiler

Mekanik Ömür	: 300.000 açma-kapama min.
Elektriksel Ömür	: 100.000 açma-kapama min.
Çalışma Sıcaklığı	: min./maks. °C -5/+40
Koruma Sınıfı	: IP50
Çalışma Sıklığı	: Yüksüz 3.000 açma-kapama/saat
	: Yükte 1.200 açma-kapama/saat
Çalışma Gerilimi (Ue)	: 240 V AC
Çalışma Akımı I(e)	: 3 A
Yalıtım Gerilimi (Ui)	: 250 V
Darbe Dayanım Gerilimi Uimp	: 2.5 kV
Anma Kesme Kapasitesi AC 15	: 1 kA
İzolasyon Direnci	: 10 MΩ min. (500 V DC)
Kullanım Sınıfı	: AC15
Dielektrik Mukavemeti	: 1.500 V AC (1 dk. için)
Standart Kontak Malzemesi	: AgNi
Bağlantı Kablo Kesiti	: 1.5 - 2.5 mm <sup>2</sup>
Standart	: UL 508 TS EN 60947-5-1 VDE0660



## MB Monoblock Series Ø 22mm Control Units

- Finger safe protection for maximum safety
- Impact-resistant polycarbonate button lens
- Various legend plates with different languages and custom markings
- Variety of products for all areas of application
- Monoblock strong body

### Technical Information

Mechanical Life	: 300.000 operations min.
Electrical Life	: 100.000 operations min.
Operating Temperature	: min./max. °C -5/+40
Protection Degree	: IP50
Operating Frequency	: Without load 3.000 operations/hour
	: At full load 1.200 operations/hour
Operating Voltage (Ue)	: 240 V AC
Operating Current (Ie)	: 3 A
Insulation Voltage (Ui)	: 250 V
Impact Resistance (Uimp)	: 2.5 kV
Short Circuit Breaking Capacity (Icn)	: 1 kA
Insulation Resistance	: 10 MΩ min. (500 V DC)
Utilization Category	: AC15
Dielectric Strength	: 1.500 V AC (For 1 minute)
Standard Contact Material	: AgNi
Cable Section	: 1.5 - 2.5 mm <sup>2</sup>
Standard	: UL 508 TS EN 60947-5-1 VDE0660



# Kumanda Butonları ve Sinyal Lambaları

## Control Units and Pilot Lights



### MB Monoblok Serisi Ø 22mm Kumanda Butonlar Genel Şema

MB Monoblock Series Ø 22mm Control Units General Scheme

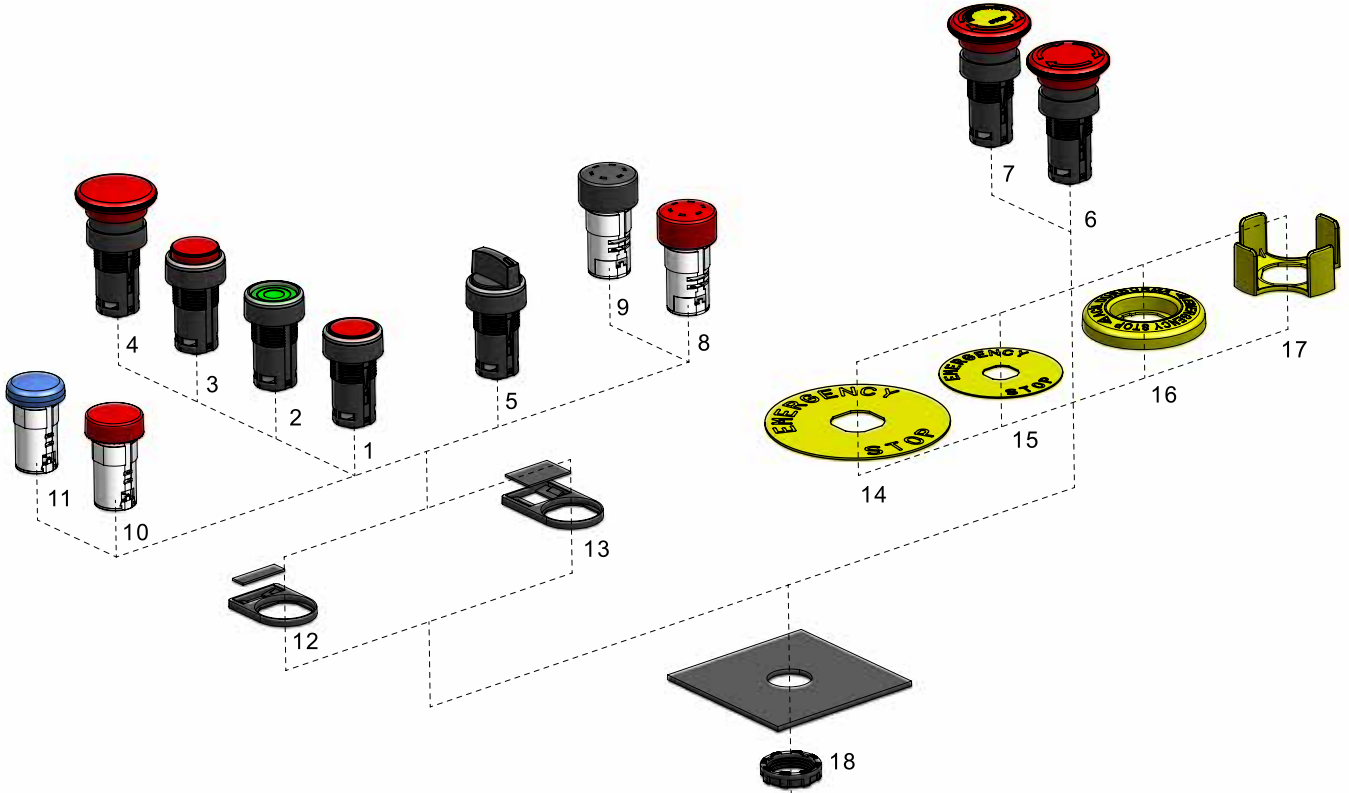

#### Yaylı Tip / Spring Type

- |   |   |                                     |
|---|---|-------------------------------------|
| 1 | D | Düz / Flush                         |
| 2 | F | Kalıcı / Stay Put                   |
| 3 | H | Çıkık / Extended                    |
| 4 | M | Mantar, Ø 40 mm / Mushroom, Ø 40 mm |

#### Seçici Tip / Selector Type

- |   |   |           |
|---|---|-----------|
| 5 | S | 60° / 60° |
|---|---|-----------|

#### Acil Stop / Emergency Stop Type

- |   |    |   |
|---|----|---|
| 6 | E  | Ø 40mm, Çevirmeli / Ø 40mm, Turn to Release                       |
| 7 | EE | Ø 40mm, Etiketli, Çevirmeli / Ø 40mm, With Label, Turn to Release |

#### Buzzer / Buzzer

- |   |    |                                |
|---|----|--------------------------------|
| 8 | ZS | Işıklı / Illuminated           |
| 9 | ZX | Işıksız / Without Illumination |

#### Sinyal / Pilots

- |    |    |  |
|----|----|--|
| 10 | SD | Düz, LED, Sinyal / Flat, LED, Pilots,        |
| 11 | SP | Petekli, LED, Sinyal / Cellular, LED, Pilots |

#### Aksesuarlar / Accessories

- |    |           |  |
|----|-----------|--|
| 12 | BROZET08  | Rozet, 8mm / Legend Plate Holder, 8mm  |
| 13 | BROZET18  | Rozet, 18mm / Legend Plate Holder, 18mm  |
| 14 | BET90A/P  | Etiket, Ø90mm Acil Stop, Alüminyum / Plastik / Legend Plate, Ø90mm Emergency Stop, Aluminium / Plastic |
| 15 | BET60A/P  | Etiket, Ø60mm Acil Stop, Alüminyum / Plastik / Legend Plate, Ø60mm Emergency Stop, Aluminium / Plastic |
| 16 | BET60LED  | Etiket, Ø60mm Acil Stop, LED / LED Illuminated Legend Plate, Ø60mm Emergency Stop                      |
| 17 | BMUHAFAZA | Emniyet Koruma / Emergency Protective Cover  |
| 18 | SOMUN     | Plastic Somun, M22 X 1,5 / Plastic Nut, M22 X 1,5  |

# Kumanda Butonları ve Sinyal Lambaları

## Control Units and Pilot Lights



### MB Serisi Monoblok Kumanda Butonlar Seçim Tablosu

#### Series Monoblock Control Units Selection Table

Seri	Kontakt Blok Kombinasyonu	Buton Tipi	Renk	Yazı
<b>MB</b> Series	<b>1 0 2</b> Contact Block Combination	<b>D</b> Button Type	<b>K</b> Colour	<b>1</b> Pad Printing
<b>Seri</b> Series <b>MB</b> Serisi Monoblok Ø 22mm Kumanda Butonu Series Monoblock Ø 22mm Control Units	<b>Kontakt Blok Tipi</b> Contact Block Type <b>1</b> Start Butonluk Start For Button <b>2</b> Stop Butonluk Stop For Button	<b>Buton Tipi</b> Button Type <b>Yaylı Tip</b> Spring Type <b>D</b> Düz Flush <b>F</b> Kalıcı Stay Put <b>H</b> Çıkık Extended <b>M</b> Mantar Mushroom Ø 40 mm Ø 40 mm	<b>Renk</b> Colour <b>B</b> Beyaz White <b>K</b> Kırmızı Red <b>M</b> Mavi Blue <b>S</b> Sarı Yellow <b>Y</b> Yeşil Green <b>H</b> Siyah Black	<b>Yazı</b> Pad Printing <b>0</b> 0 0 <b>10</b> I-0 I-0 <b>1</b> I I <b>2</b> II II <b>12</b> I-II I-II <b>L</b> LIGHT LIGHT <b>OD</b> OK Vertical Arrow <b>OY</b> OK Horizontal Arrow <b>OK</b> OK Special Arrow <b>OO</b> OK Special Arrow <b>S</b> Siren İşareti Siren Symbol <b>Z</b> Zil İşareti Bell Symbol
<b>Kontakt Blok Tipi</b> Contact Block Type <b>1</b> Start Butonluk Start For Button <b>2</b> Stop Butonluk Stop For Button	<b>Işık Bloğu Tipi</b> Illumination Block Type <b>0</b> Boş Without Illumination	<b>Seçici Tip</b> Selector Type <b>S20</b> 2 Pozisyonlu Kalıcı 2 Position Stay Put (0-I) 60° <b>S21</b> 2 Pozisyonlu Dönüşlü 2 Position Spring Return (0-I) 60° <b>S30</b> 3 Pozisyonlu Kalıcı 3 Position Stay Put (II-0-I) 60° <b>S31</b> 3 Pozisyonlu Tek Dönüşlü 3 Position Single Spring Return (II-0-I) 60° <b>S32</b> 3 Pozisyonlu Çift Dönüşlü 3 Position Double Spring Return (II-0-I) 60°	<b>Acil Stop Tip</b> Emergency Stop Type <b>E</b> Ø 40mm Çevirmeli Ø 40mm Turn to Release <b>EE</b> Ø 40mm Etiketli Çevirmeli Ø 40mm With Label Turn to Release	<b>Sinyal</b> Pilot Lights <b>X</b> Sinyal Pilot Lights
			<b>Yazılı</b> Printed <b>Dikey Yazılı</b> Vertical Arrow <b>Yatay Yazılı</b> Horizontal Arrow <b>Özel Yazılı</b> Special Arrow <b>Özel Yazılı</b> Special Arrow <b>Printed</b> <b>Printed</b>	

H1K2DK → H Serisi, start-stop, 100 - 230V AC, kırmızı LEDli, kırmızı renkli, Düz, buton seçilmiştir.

Örnek: MB102DK → MB Monoblok serisi, start-stop, kırmızı renkli, Düz Buton seçilmiştir.

Example: MB102DK → MB Monoblock series, start-stop, red, Flush Button has been selected.



# Kumanda Butonları ve Sinyal Lambaları

## Control Units and Pilot Lights



### Yaylı Tip Kumanda Butonları / Spring Type Control Units

Ürün Kodu Code	Kontakt Blok Tipi Contact Block Type		Buton Tipi Button Type	Renk Colour
	Normal Açık Normally Open	Normal Kapalı Normally Closed		
MB100D*	1	-	Düz / Flush	
MB101D*	2	-	Düz / Flush	
MB102D*	1	1	Düz / Flush	
MB200D*	-	1	Düz / Flush	
MB202D*	-	2	Düz / Flush	
MB100F*	1	-	Kalıcı / Stay Put	
MB101F*	2	-	Kalıcı / Stay Put	
MB102F*	1	1	Kalıcı / Stay Put	
MB200F*	-	1	Kalıcı / Stay Put	
MB202F*	-	2	Kalıcı / Stay Put	
MB100H*	1	-	Çıkık / Extended	
MB101H*	2	-	Çıkık / Extended	
MB102H*	1	1	Çıkık / Extended	
MB200H*	-	1	Çıkık / Extended	
MB202H*	-	2	Çıkık / Extended	
MB100M*	1	-	Mantar / Mushroom	
MB101M*	2	-	Mantar / Mushroom	
MB102M*	1	1	Mantar / Mushroom	
MB200M*	-	1	Mantar / Mushroom	
MB202M*	-	2	Mantar / Mushroom	



MB102DM



MB100DY



MB200MK



MB100FY



MB100HY

### Seçici Tip Kumanda Butonları / Selector Type Control Units

Ürün Kodu Code	Kontakt Blok Tipi Contact Block Type		Işık Illumination	Etiket Button Plates	Buton Tipi Button Type	Pozisyon Position	Renk Colour
	Normal Açık Normally Open	Normal Kapalı Normally Closed	LED LED				
MB100S20	1	-	-	0-I	Seçici / Selector	2 Pozisyonlu-Kalıcı-60° / 2 Position-Stay Put-60°	
MB101S20	2	-	-	0-I	Seçici / Selector	2 Pozisyonlu-Kalıcı-60° / 2 Position-Stay Put-60°	
MB102S20	1	1	-	0-I	Seçici / Selector	2 Pozisyonlu-Kalıcı-60° / 2 Position-Stay Put-60°	
MB100S21	1	-	-	0-I	Seçici / Selector	2 Pozisyonlu-Dönüşlü-60° / 2 Position-Spring Return-60°	
MB101S21	1	1	-	0-I	Seçici / Selector	2 Pozisyonlu-Dönüşlü-60° / 2 Position-Spring Return-60°	
MB101S30	2	-	-	II-0-I	Seçici / Selector	3 Pozisyonlu-Kalıcı -60° / 3 Position-Stay Put-60°	
MB101S31	2	-	-	II-0-I	Seçici / Selector	3 Pozisyonlu-Tek Dönüşlü-60° / 3 Position-Single Spring Return-60°	
MB101S32	2	-	-	II-0-I	Seçici / Selector	3 Pozisyonlu-Çift Dönüşlü -60° / 3 Position-Double Spring Return-60°	



MB100S20

# Kumanda Butonları ve Sinyal Lambaları

## Control Units and Pilot Lights



### MB Serisi Monoblok Ø 22 mm Kumanda Buton Tipleri

#### Series Monoblock Ø 22 mm Control Units Types

#### Acil Stop Tip Kumanda Butonları / Emergency Stop Type Control Units

Ürün Kodu	Kontakt Blok Tipi	Etiket	Tip	Çap (mm)	Renk
Code	Contact Block Type	Button Plates	Type	Dia (mm)	Colour
	 Normal Açık Normally Open	 Normal Kapalı Normally Closed			
MB100E	1	-	Çevirmeli / Turn to Release	Ø 40mm	K
MB102E	1	1	Çevirmeli / Turn to Release	Ø 40mm	K
MB200E	-	1	Çevirmeli / Turn to Release	Ø 40mm	K
MB202E	-	2	Çevirmeli / Turn to Release	Ø 40mm	K
MB100EE	1	-	✓ Etiketli - Çevirmeli / With Label - Turn to Release	Ø 40mm	K
MB102EE	1	1	✓ Etiketli - Çevirmeli / With Label - Turn to Release	Ø 40mm	K
MB200EE	-	1	✓ Etiketli - Çevirmeli / With Label - Turn to Release	Ø 40mm	K
MB202EE	-	2	✓ Etiketli - Çevirmeli / With Label - Turn to Release	Ø 40mm	K



MB200E



MB200EE

#### Buzzerlar / Buzzers

Ürün Kodu	Işık	Özellik	Nominal Gerilim	Özellik	Renk
Code	Illumination	Features	Nominal Voltage	Features	Colour
MBZX012S	LED	IP40	12V AC/DC	90 db (10cm uzaklıkta) Sabit / 90 db (10cm distance) Single Melody	K
MBZS024S	LED	IP40	24V AC/DC	90 db (10cm uzaklıkta) Sabit / 90 db (10cm distance) Single Melody	K
MBZS024SE	LED	IP65	24V AC/DC	85 db (10cm uzaklıkta) Sabit / 85db (10cm distance) Single Melody	K
MBZS110S	LED	IP40	110V AC	90 db (10cm uzaklıkta) Sabit / 90 db (10cm distance) Single Melody	K
MBZS220S	LED	IP40	220V AC	90 db (10cm uzaklıkta) Sabit / 90 db (10cm distance) Single Melody	K
MBZS220SE	LED	IP65	220V AC	85 db (10cm uzaklıkta) Sabit / 85db (10cm distance) Single Melody	K
MBZX024S	LED	IP40	24V AC/DC	90 db (10cm uzaklıkta) Sabit / 90 db (10cm distance) Single Melody	K
MBZX024SE	LED	IP65	24V AC/DC	85 db (10cm uzaklıkta) Sabit / 85db (10cm distance) Single Melody	K
MBZX110S		IP40	110V AC	90 db (10cm uzaklıkta) Sabit / 90 db (10cm distance) Single Melody	H
MBZX220S		IP40	220V AC	90 db (10cm uzaklıkta) Sabit / 90 db (10cm distance) Single Melody	H
MBZX220SE		IP65	220V AC	85 db (10cm uzaklıkta) Sabit / 85db (10cm distance) Single Melody	H

- IP65 istendiğinde sonuna "E" harfi eklenmektedir. Ses 5 desibel düşmektedir.
- For IP65 preferences, please add "E" letter to end of the code. In case of IP65 preferences, volume has been decreased 5 db.



MBZS024S



MBZX220S

# Kumanda Butonları ve Sinyal Lambaları

## Control Units and Pilot Lights



### Sinyaller / Pilot Lights

Ürün Kodu	Işık	Özellik	Nominal Gerilim	Renk
Code	Illumination	Features	Nominal Voltage	Colour
MBSD012*	LED	Düz / Flat	12V AC/DC	B K M S Y H
MBSD024*	LED	Düz / Flat	24V AC/DC	B K M S Y H
MBSD110*	LED	Düz / Flat	110V AC	B K M S Y H
MBSD220*	LED	Düz / Flat	220V AC	B K M S Y H
MBSP012*	LED	Petekli / Cellular	12V AC/DC	B K M S Y H
MBSP024*	LED	Petekli / Cellular	24V AC/DC	B K M S Y H
MBSP110*	LED	Petekli / Cellular	110V AC	B K M S Y H
MBSP220*	LED	Petekli / Cellular	220V AC	B K M S Y H



MBSD024Y



MBSP220M

### Özel Tampon Baskılı Butonlar / Special Pad Printed Control Units

Ürün Kodu / Code	MB100DY-0D	MB100DY-0Y	MB100DH-0D	MB100DH-0Y	MB100DB-0D	MB100DB-0Y	MB100DB-Z	MB100DB-L
Baskı / Print	Dikey Oklu Vertical Arrow	Yatay Oklu Horizontal Arrow	Dikey Oklu Vertical Arrow	Yatay Oklu Horizontal Arrow	Dikey Oklu Vertical Arrow	Yatay Oklu Horizontal Arrow	Zil / Bell	Lamba / Lamp
Ürün Kodu / Code	MB100DY-1	MB100DY-2	MB100DB-1	MB100DB-2	MB200DK-0	MB200DH-0	MB200DS-Z	MB200DS-L
Baskı / Print	I	II	I	II	O	O	Zil / Bell	Lamba / Lamp

### Aksesuarlar / Accessories

Ürün Kodu	Tip	Özellik
Code	Type	Features
BPUL	Pul / Plate	Buton Sıkıştırma / Button Tightening
BSOMAN	Somun Anahtarları / Nut Tightener	

# Kumanda Butonları ve Sinyal Lambaları

## Control Units and Pilot Lights



### BOYUTLAR (mm) / DIMENSIONS (mm)

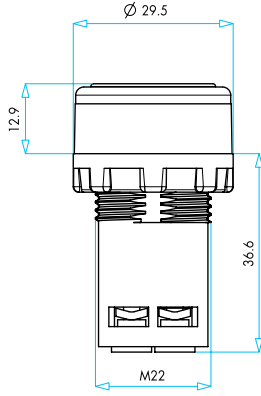

Düz Kafalı Yaylı Buton  
Flush, Spring Return

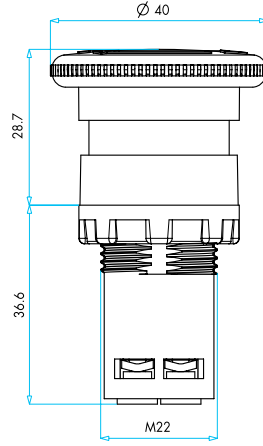

40 mm Acil Stop Butonu  
40 mm Emergency Stop

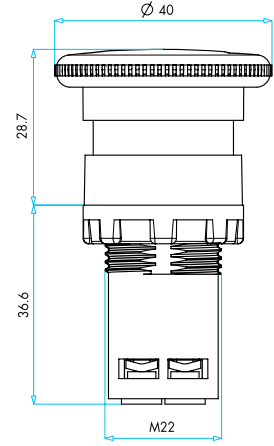

40 mm Mantar Buton  
40 mm Mushroom Button

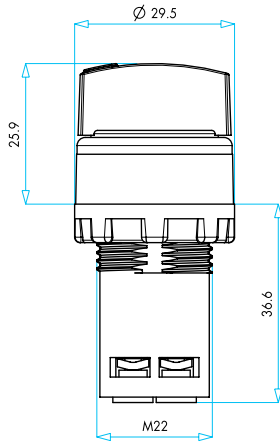

Seçici Buton  
Selector Switch

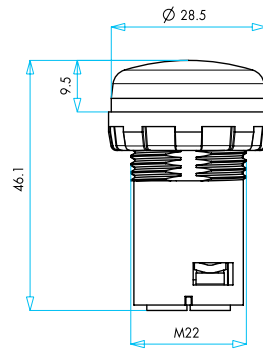

Sinyal (Petekli Cam)  
Signal (Comb Glass)

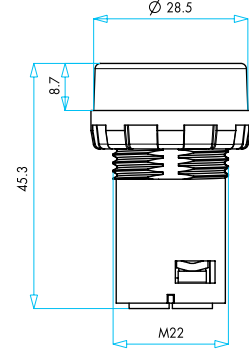

Sinyal (Düz Cam)  
Signal (Flat Glass)

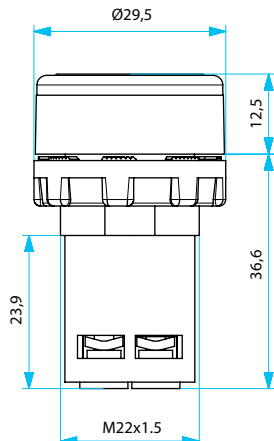

Monoblok Kalıcı Buton  
Monoblock Stay-Put Button

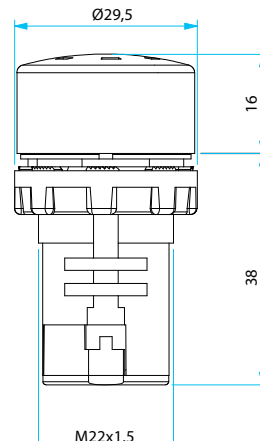

Monoblok Buzzer  
Monoblock Buzzer



## KB Serisi Ø 22mm Kumanda Butonları

- Darbe dayanıklı polikarbonat buton lensi
- Alev almayan VO PA6.6 kontak bloklar
- Farklı dillerde ve özel işaretli çeşitli markalama etiketleri
- Tüm uygulamalara cevap verecek ürün çeşitliliği
- 1980'den beri güvenle kullanılan tasarım

### Teknik Bilgiler

Mekanik Ömür	: 500.000 açma-kapama min.
Elektriksel Ömür	: 100.000 açma-kapama min.
Çalışma Sıcaklığı	: min./maks. °C -5/+40
Koruma Sınıfı	: IP50
Çalışma Sıklığı	: Yüksüz 3.000 açma-kapama/saat
	: Yükte 1.200 açma-kapama/saat
Anma İşletme Gerilimi (Ue)	: 220 V AC
Anma İşletme Akımı (Ie)	: 4 A
Yalıtım Gerilimi (Ui)	: 300 V
Darbe Dayanım Gerilimi (Uimp)	: 2.5 kV
Anma Kesme Kapasitesi AC 15	: 1 kA
İzolasyon Direnci	: 10 MΩ min. (500 V DC)
Kullanım Sınıfı	: AC15
Dielektrik Mukavemeti	: 1.500 V AC (1 dk. için)
Standart Kontak Malzemesi	: AgNi
Bağlantı Kablo Kesiti	: 1.5 - 2.5 mm <sup>2</sup>
Standart	: UL 508 TS EN 60947-5-1 VDE0660



## KB Series Ø 22mm Control Units

- Impact-resistant polycarbonate button lens
- Non-flammable VO PA6.6 contact blocks
- Various legend plates with different languages and custom markings
- Variety of products for all areas of application
- Reliable design since 1980

### Technical Information

Mechanical Life	: 500.000 operations min.
Electrical Life	: 100.000 operations min.
Operating Temperature	: min./max. °C -5/+40
Protection Degree	: IP50
Operating Frequency	: Without load 3.000 operations/hour
	: At full load 1.200 operations/hour
Operating Voltage (Ue)	: 220 V AC
Operating Current (Ie)	: 4 A
Insulation Voltage (Ui)	: 300 V
Impact Resistance (Uimp)	: 2.5 kV
Short Circuit Breaking Capacity (Icn)	: 1 kA
Insulation Resistance	: 10 MΩ min. (500 V DC)
Utilization Category	: AC15
Dielectric Strength	: 1.500 V AC (For 1 minute)
Standard Contact Material	: AgNi
Cable Section	: 1.5 - 2.5 mm <sup>2</sup>
Standard	: UL 508 TS EN 60947-5-1 VDE0660



# Kumanda Butonları ve Sinyal Lambaları Control Units and Pilot Lights



## KB Serisi Ø 22mm Kumanda Butonları Genel Şema

KB Series Ø 22mm Control Units General Scheme

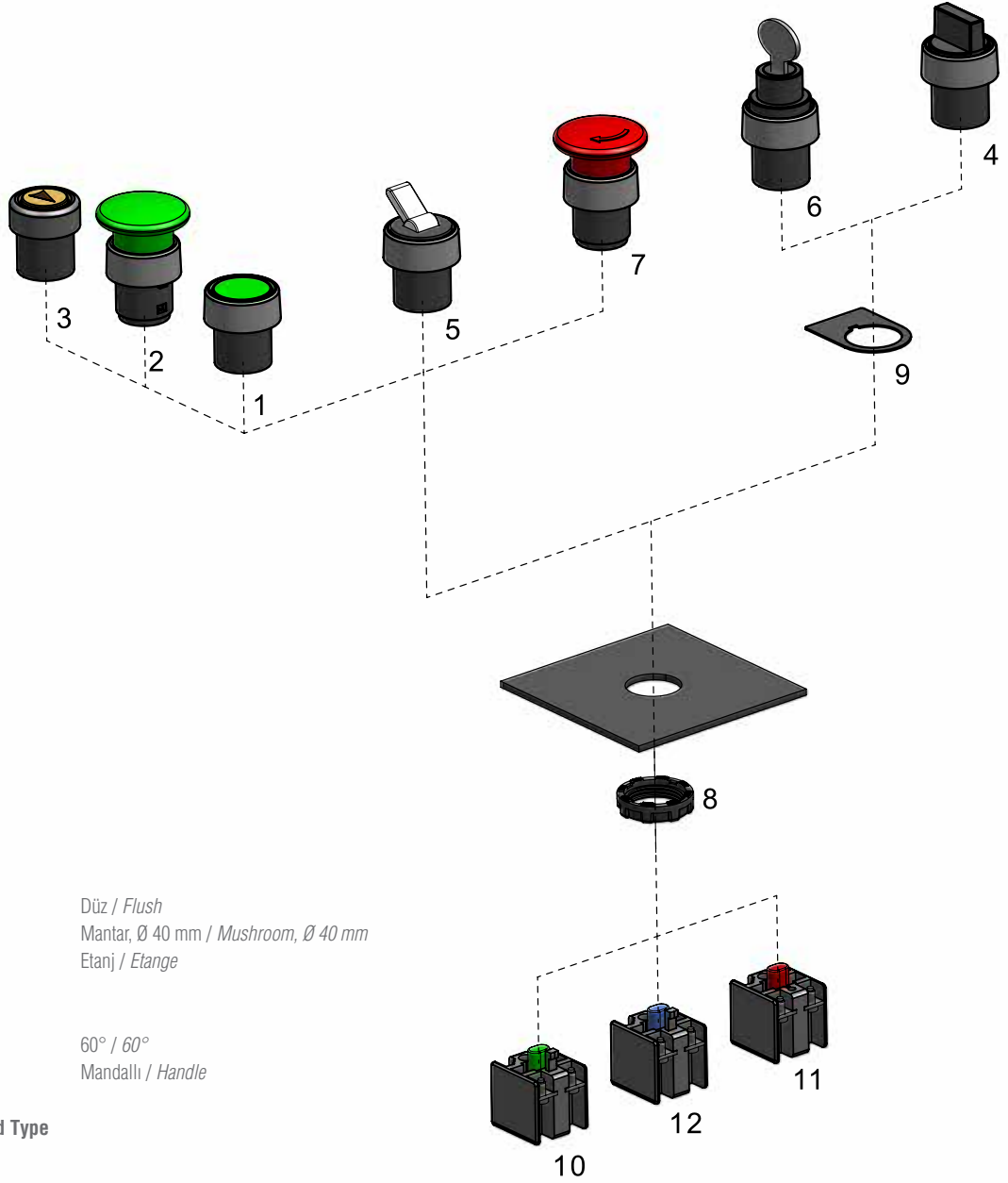

### Yaylı Tip / Spring Type

- 1 D Düz / Flush  
2 M Mantar, Ø 40 mm / Mushroom, Ø 40 mm  
3 R Etanj / Etange

### Seçici Tip / Selector Type

- 4 S2 60° / 60°  
5 C Mandallı / Handle

### Anahtarlı Tip / Key Operated Type

- 6 A2

### Acil Stop / Emergency Stop Type

- 7 E Ø 40mm, Çevirmeli / Ø 40mm, Turn to Release

### Aksesuarlar / Accessories

- 8 SOMUN Plastic Somun, M22 X 1,5 / Plastic Nut, M22 X 1,5  
9 ROZET Rozet, KB Buton / Legend Plate Holder, KB Buton  
10 START KONTAKBLOK Kontak Blok, Start (NA) / Contact Block, Start (NO)  
11 STOP KONTAKBLOK Kontak Blok, Stop (NK) / Contact Block, Stop (NC)  
12 START-STOP KONTAK BLOK Kontak Blok, Start-Stop (NA+NK) / Contact Block, Start-Stop (NO+NC)

# Kumanda Butonları ve Sinyal Lambaları

## Control Units and Pilot Lights



### KB Serisi Kumanda Butonlar Seçim Tablosu

#### Series Control Units Selection Table

Seri	Kontakt Tipi	Buton Tipi	Renk	Yazı
<b>KB</b> Series	<b>12</b> Contact Block Type	<b>D</b> Button Type	<b>K</b> Colour	<b>1</b> Pad Printing
<b>Seri</b> Series <b>KB</b> Serisi Ø 22mm Kumanda Butonu Series Ø 22mm Control Units	<b>Kontakt Blok Tipi</b> Contact Block Type <b>12</b> Stop Stop <b>14</b> Çift Devre Double Circuit <b>34</b> Start Start	<b>Buton Tipi</b> Button Type <b>Yaylı Tip</b> Spring Type <b>D</b> Düz Flush <b>M</b> Mantar Ø40 mm Mushroom Ø 40 mm <b>R</b> Etanj Etange <b>Seçici Tip</b> Selector Type <b>S2</b> 2 Pozisyonlu Kalıcı 2 Position Stay Put <b>C</b> Mandallı Handle <b>Anahtarlı Tip</b> Key Operated Type <b>A2</b> 2 Pozisyonlu 0 Pozisyonunda Anahtarı Çıkan Kalıcı 2 Position Key Removal at 0 position Stay Put <b>Acil Stop Tip</b> Emergency Stop Type <b>E</b> Ø 40mm Çevirmeli Ø 40mm Turn to Release	<b>Renk</b> Colour <b>B</b> Beyaz White <b>K</b> Kırmızı Red <b>M</b> Mavi Blue <b>S</b> Sarı Yellow <b>Y</b> Yeşil Green <b>H</b> Siyah Black <b>0</b> 0 Yazılı 0 Printed	<b>Yazı</b> Pad Printing <b>1</b>

**Örnek:** KB12DK → KB Serisi Stop, Düz kırmızı buton seçilmiştir.

**Example:** KB12DK → KB Series, Stop, Flush, Red button has been selected.

# Kumanda Butonları ve Sinyal Lambaları

## Control Units and Pilot Lights



### KB Serisi Ø 22 mm Kumanda Buton Tipleri

#### Series Ø 22 mm Control Units Types

#### Yaylı Tip Kumanda Butonlar / Spring Type Control Units

Ürün Kodu	Kontakt Blok Tipi		Işık	Buton Tipi	Renk
Code	Contact Block Type		Illumination	Button Type	Colour
	Normal Açık Normally Open	Normal Kapalı Normally Closed			
KB12D*		1	-	Düz / Flush	
KB14D*	1	1	-	Düz / Flush	
KB34D*	1		-	Düz / Flush	
KB12M*		1	-	Mantar / Mushroom	
KB14M*	1	1	-	Mantar / Mushroom	
KB34M*	1		-	Mantar / Mushroom	
KB12R*		1	-	Etanj / Etange	
KB14R*	1	1	-	Etanj / Etange	
KB34R*	1		-	Etanj / Etange	
KB12RB-0		1	-	Etanj Oklu / Etange	
KB14RB-0	1	1	-	Etanj Oklu / Etange	
KB34RB-0	1		-	Etanj Oklu / Etange	



KB34DY



KB12C

#### Seçici Tip Kumanda Butonları / Selector Type Control Units

Ürün Kodu	Kontakt Blok Tipi		Işık	Etiket	Buton Tipi	Pozisyon	Renk
Code	Contact Block Type		Illumination	Button Plates	Button Type	Position	Colour
			LED LED				
	Normal Açık Normally Open	Normal Kapalı Normally Closed	LED LED				
KB14S2	1	1	-	0-I	Seçici / Selector	2 Pozisyonlu-Kalıcı-60° / 2 Position-Stay Put-60°	
KB34S2	1	-	-	0-I	Seçici / Selector	2 Pozisyonlu-Kalıcı-60° / 2 Position-Stay Put-60°	
KB12C	-	1	-	0-I	Mandallı / Handle Switch		
KB14C	1	1	-	0-I	Mandallı / Handle Switch		
KB34C	1	-	-	0-I	Mandallı / Handle Switch		



KB34S2





# Kumanda Butonları ve Sinyal Lambaları

## Control Units and Pilot Lights







### Anahtarlı Tip Kumanda Butonları / Key Operated Type Control Units

Ürün Kodu	Kontakt Blok Tipi		Etiket	Tip	Pozisyon	Anahtar Çıkma Pozisyonu
Code	Contact Block Type		Button Plates	Type	Position	Key Removal Position
	 Normal Açık Normally Open	 Normal Kapalı Normally Closed				
KB14A2	1	1	(0-1)	Kalıcı / Stay Put	2 Pozisyonlu / 2 Position	0
KB34A2	1	-	(0-1)	Kalıcı / Stay Put	2 Pozisyonlu / 2 Position	0



KB14A2

### Acil Stop Tip Kumanda Butonları / Emergency Stop Type Control Units

Ürün Kodu	Kontakt Blok Tipi		Tip	Çap (mm)	Renk
Code	Contact Block Type		Type	Dia (mm)	Colour
	 Normal Açık Normally Open	 Normal Kapalı Normally Closed			
KB12E	-	1	Çevirmeli / Turn to Release	Ø 40mm	
KB14E	1	1	Çevirmeli / Turn to Release	Ø 40mm	





KB12E

# Kumanda Butonları ve Sinyal Lambaları Control Units and Pilot Lights





## Kontak Blok Tipler / Contact Block Types

Ürün Kodu Code	Kontak Blok Tipi Contact Block Type	Nominal Akım Nominal Current	Nominal Gerilim Nominal Voltage	Kullanım Yeri	
	 Normal Açık Normally Open	 Normal Kapalı Normally Closed			
KB12	-	1	4A	220V	Butonluk / For Control Units
KB14B	1	1	4A	220V	Butonluk / For Control Units
KB14K	1	1	4A	220V	Kutuluk / For Boxes
KB34B	1	-	4A	220V	Butonluk / For Control Units
KB34K	1	-	4A	220V	Kutuluk / For Boxes



KB12

## Yedekler / Spare Parts

Ürün Kodu Code	Nominal akım Nominal Current	Buton Tipi Control Unit Types	Pozisyon Position	Renk Colour
D*		Düz / Flush		
DM*		Mantar / Mushroom		
DR*		Etanj / Etange		
DR-0		Etanj Oklu / Etange		
DS2		Seçici / Selector		
DC		Mandallı / Handle Switch		
DA2	0-1	Kalıcı / Stay Put	2 Pozisyonlu / 2 Position	
DE		Çevirmeli / Turn to Release	Ø 40mm	

## **KB** Serisi Ø 22 mm Kumanda Buton Tipleri

Series Ø 22 mm Control Units Types

BOYUTLAR (mm) / DIMENSIONS (mm)

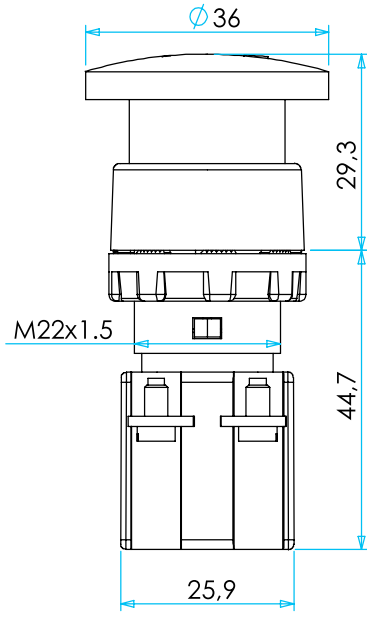

**KB14E**

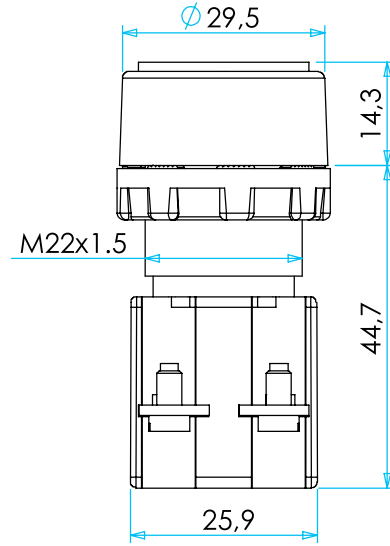

**KB14DY**

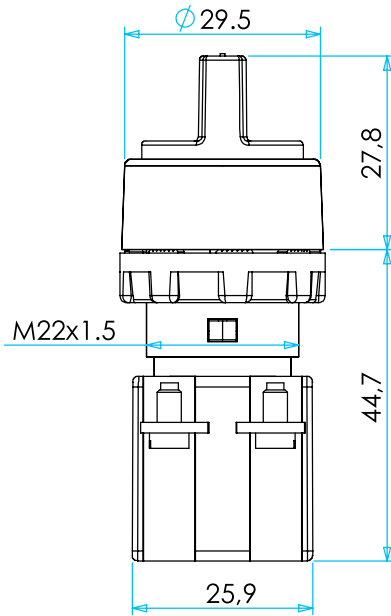

**KB14S2**

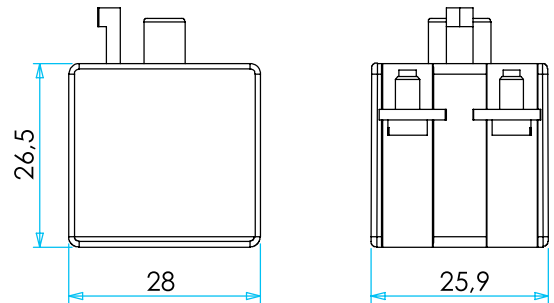

**KB14B**



### Sinyal Lambaları

- Ø10, 14, 22 mm çaplı yuvarlak sinyaller
- Darbe dayanıklı polikarbonat lens
- Farklı terminal çeşitleri ile bağlantı kolaylığı
- Değişik voltaj seçenekleri
- Somunlu veya tırnaklı sistem ile basit ve hızlı montaj

### Teknik Bilgiler

Elektriksel Ömür : min. 10.000 saat  
Çalışma Sıcaklığı : -5°C/ +85°C



### Pilot Lights

- Ø10, 14, 22 mm round types
- Impact - resistant polycarbonate lens
- Connection facility with different terminal types
- Different voltage variety
- Basic and fast mounting with nut and fingerproof system

### Technical Information

Electrical Life : min. 10.000 hours  
Operating Temperature : -5°C/ +85°C



# Kumanda Butonları ve Sinyal Lambaları

## Control Units and Pilot Lights



### Sinyal Lambaları

#### Pilot Lights



S100K



S100LK

Ürün Kodu	Cam Tipi	Bağlantı Tipi	Montaj Tipi	Çalışma Gerilimi (V)	Ampul ve Duy Tipi
Code	Lens Type	Connection Type	Mounting Type	Voltage	Lamp and Socket Type
S100*	Yuvarlak, İnce, Termo Round, Thin, Thermo	Kablolu With Cable	Somunlu With Nut	230V AC	Neon Neon
S100L*	Yuvarlak, İnce, Termo Round, Thin, Thermo	Kablolu With Cable	Somunlu With Nut	230V AC	LED LED
S100L1*	Yuvarlak, İnce, Termo Round, Thin, Thermo	Kablolu With Cable	Somunlu With Nut	12V AC/DC	LED LED
S100L2*	Yuvarlak, İnce, Termo Round, Thin, Thermo	Kablolu With Cable	Somunlu With Nut	24V AC/DC	LED LED

\* Renk/Colour B: Beyaz/White, K: Kırmızı/Red, M: Mavi/Blue, S: Sarı/Yellow, Y: Yeşil/Green



S102S

Ürün Kodu	Cam Tipi	Bağlantı Tipi	Montaj Tipi	Çalışma Gerilimi (V)	Ampul ve Duy Tipi
Code	Lens Type	Connection Type	Mounting Type	Voltage	Lamp and Socket Type
S102*	Yuvarlak, İnce, Termo Round, Thin, Thermo	Terminalli With Terminal	Somunlu With Nut	230V AC	Neon Neon
S102L*	Yuvarlak, İnce, Termo Round, Thin, Thermo	Terminalli With Terminal	Somunlu With Nut	230V AC/DC	LED LED
S102L1*	Yuvarlak, İnce, Termo Round, Thin, Thermo	Terminalli With Terminal	Somunlu With Nut	12V AC/DC	LED LED
S102L2*	Yuvarlak, İnce, Termo Round, Thin, Thermo	Terminalli With Terminal	Somunlu With Nut	24V AC/DC	LED LED

\* Renk/Colour B: Beyaz/White, K: Kırmızı/Red, M: Mavi/Blue, S: Sarı/Yellow, Y: Yeşil/Green



S105Y

Ürün Kodu	Cam Tipi	Bağlantı Tipi	Montaj Tipi	Çalışma Gerilimi (V)	Ampul ve Duy Tipi
Code	Lens Type	Connection Type	Mounting Type	Voltage	Lamp and Socket Type
S105*	Yuvarlak, İnce, Termo Round, Thin, Thermo	Terminalli With Terminal	Somunsuz Nutless	230V AC	Neon Neon

\* Renk/Colour B: Beyaz/White, K: Kırmızı/Red, M: Mavi/Blue, S: Sarı/Yellow, Y: Yeşil/Green



S140K

Ürün Kodu	Cam Tipi	Bağlantı Tipi	Montaj Tipi	Çalışma Gerilimi (V)	Ampul ve Duy Tipi
Code	Lens Type	Connection Type	Mounting Type	Voltage	Lamp and Socket Type
S140*	Yuvarlak, İnce, Termo Round, Thin, Thermo	Terminalli With Terminal	Somunsuz Nutless	230V AC	Neon Neon

\* Renk/Colour B: Beyaz/White, K: Kırmızı/Red, M: Mavi/Blue, S: Sarı/Yellow, Y: Yeşil/Green

# Kumanda Butonları ve Sinyal Lambaları

## Control Units and Pilot Lights



### Sinyal Lambaları

#### Pilot Lights



S140Y2

Ürün Kodu	Cam Tipi	Bağlantı Tipi	Montaj Tipi	Çalışma Gerilimi (V)	Ampul ve Duy Tipi
Code	Lens Type	Connection Type	Mounting Type	Voltage	Lamp and Socket Type
S140*1	Yuvarlak, İnce, Termo Round, Thin, Thermo	Terminalli With Terminal	Somunlu With Nut	12V AC / DC	Flamanlı With Filament
S140*2	Yuvarlak, İnce, Termo Round, Thin, Thermo	Terminalli With Terminal	Somunlu With Nut	24V AC / DC	Flamanlı With Filament

\* Renk/Colour B: Beyaz/White, K: Kırmızı/Red, M: Mavi/Blue, S: Sarı/Yellow, Y: Yeşil/Green



S145S

Ürün Kodu	Cam Tipi	Bağlantı Tipi	Montaj Tipi	Çalışma Gerilimi (V)	Ampul ve Duy Tipi
Code	Lens Type	Connection Type	Mounting Type	Voltage	Lamp and Socket Type
S145*	Yuvarlak, İnce, Termo Round, Thin, Thermo	Terminalli With Terminal	Somunsuz Nutless	230V AC	Neon Neon
S145*1	Yuvarlak, İnce, Termo Round, Thin, Thermo	Terminalli With Terminal	Somunsuz Nutless	12V AC / DC	Flamanlı With Filament
S145*2	Yuvarlak, İnce, Termo Round, Thin, Thermo	Terminalli With Terminal	Somunsuz Nutless	24V AC / DC	Flamanlı With Filament

\* Renk/Colour B: Beyaz/White, K: Kırmızı/Red, M: Mavi/Blue, S: Sarı/Yellow, Y: Yeşil/Green



S220K

Ürün Kodu	Cam Tipi	Bağlantı Tipi	Montaj Tipi	Çalışma Gerilimi (V)	Ampul ve Duy Tipi
Code	Lens Type	Connection Type	Mounting Type	Voltage	Lamp and Socket Type
S220*	Yuvarlak, Konik, Normal Round, Conic, Normal	Vidalı Screw Mounting	Somunlu With Nut	230V AC	Neon - Plastik Neon - Plastic
S220*6	Yuvarlak, Konik, Normal Round, Conic, Normal	Vidalı Screw Mounting	Somunlu With Nut	-	Neon - Vidalı Neon - Screwed

\* Renk/Colour B: Beyaz/White, K: Kırmızı/Red, M: Mavi/Blue, S: Sarı/Yellow, Y: Yeşil/Green

# Kumanda Butonları ve Sinyal Lambaları

## Control Units and Pilot Lights



S222K



S222LS



S224Y

Ürün Kodu	Cam Tipi	Bağlantı Tipi	Montaj Tipi	Çalışma Gerilimi (V)	Ampul ve Duy Tipi
Code	Lens Type	Connection Type	Mounting Type	Voltage	Lamp and Socket Type
S222*	Düz, Petek, Termo Flat, Cellular, Thermo	Vidalı Screw Mounting	Somunlu With Nut	230V AC	Neon - Plastik Neon - Plastic
S222L*	Düz, Petek, Termo Flat, Cellular, Thermo	Vidalı Screw Mounting	Somunlu With Nut	230V AC	LED LED

\* Renk/Colour B: Beyaz/White, K: Kırmızı/Red, M: Mavi/Blue, S: Sarı/Yellow, Y: Yeşil/Green

Ürün Kodu	Cam Tipi	Bağlantı Tipi	Montaj Tipi	Çalışma Gerilimi (V)	Ampul ve Duy Tipi
Code	Lens Type	Connection Type	Mounting Type	Voltage	Lamp and Socket Type
S224*	Düz, Petek, Termo Flat, Cellular, Thermo	Terminalli / Vidalı With Terminal / Screw Mounting	Somunlu With Nut	230V AC	Neon - Sürgülü Neon - Bayonet Ba9s
S224*7	Düz, Petek, Termo Flat, Cellular, Thermo	Terminalli / Vidalı With Terminal / Screw Mounting	Somunlu With Nut	-	Sürgülü Ba9s - 10 mm Bayonet Ba9s - 10 mm

\* Renk/Colour B: Beyaz/White, K: Kırmızı/Red, M: Mavi/Blue, S: Sarı/Yellow, Y: Yeşil/Green

### Ampuller / Neon Lamps



PDA



N201



NA101



LED220K



LED24S

Ürün Kodu	Çalışma Gerilimi (V)	Akım (mA)	Ampul ve Duy Tipi	Ömür (s)	Renk
Code	Voltage	Current	Lamp and Socket Type	Life (h)	Colour
PDA	230 V AC	1.10÷1.80	Neon-Plastik Neon-Plastic	10.000	Sarı Yellow
NA101	230 V AC	0.80÷1.70	Neon-Vidalı 10 mm EX-10 Neon-Screw 10 mm EX-10	10.000	Sarı Yellow
NA101Y	230 V AC	0.45÷1.00	Neon-Vidalı 10 mm EX-10 Neon-Screw 10 mm EX-10	10.000	Yeşil Green
NA201	230 V AC	2.30÷2.50	Neon-Sürgülü 10 mm Ba9s Neon-Bayonet 10 mm Ba9s	10.000	Sarı Yellow
NA201Y	230 V AC	1.60÷1.80	Neon-Sürgülü 10 mm Ba9s Neon-Bayonet 10 mm Ba9s	10.000	Yeşil Green
LED24*	24 VDC/ AC		Ba9S Duyulu LED		* *
LED220*	220 V AC		Ba9S Duyulu LED		* *

\* Beyaz, Kırmızı, Mavi, Sarı, Yeşil / White, Red, Blue, Yellow, Green

# Kumanda Butonları ve Sinyal Lambaları

## Control Units and Pilot Lights



BOYUTLAR (mm) / DIMENSIONS (mm)

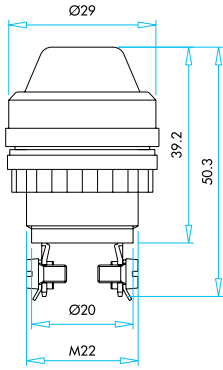

S220

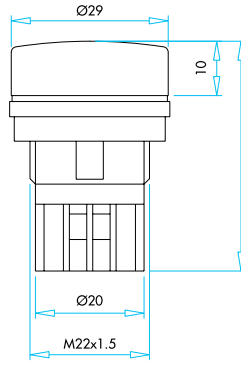

S222

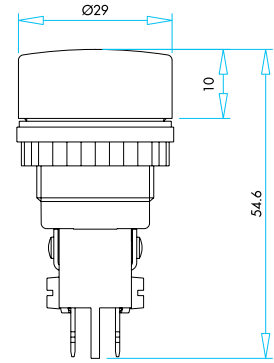

S224

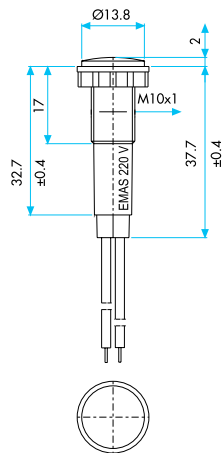

S100

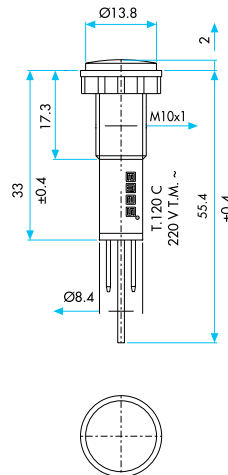

S102

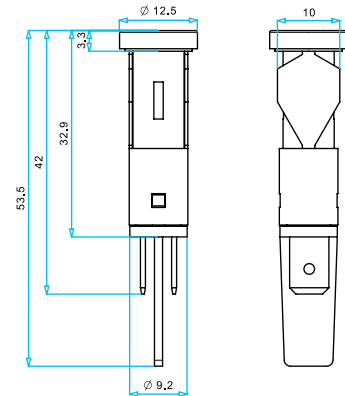

S105

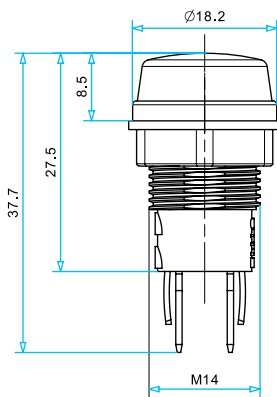

S140

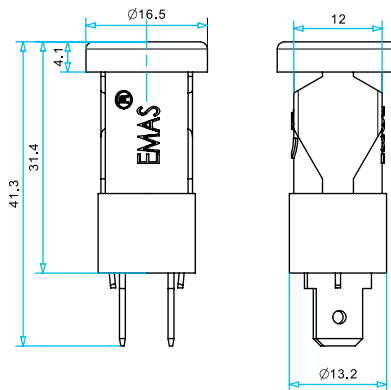

S145