









6 A / 250 V AC

• Miniature dimensions • Cadmium - free contacts • AC and DC coils • For plug-in sockets, 35 mm rail mount acc. to PN-EN 60715 or on panel mounting • For PCB and for soldering connections - option • Relays of general application • WT (mechanical indicator + lockable front test button) - standard features of relays for plug-in sockets. Relays may be provided with the test buttons (no latching) and plugs - page 251 • **Have obtained LR Type Approval Certificate (Lloyd's Register) - R4...WT** • Recognitions, certifications, directives: RoHS, AUCOTEAM GmbH Berlin - railway standards,      

Contact data

Number and type of contacts		4 C/O	
Contact material		AgNi , AgNi/Au 0,2 µm, AgNi/Au 5 µm	
Rated / max. switching voltage	AC	250 V / 250 V	
Min. switching voltage		5 V	
Rated load (capacity)	AC1	6 A / 250 V AC	
	AC15	1,5 A / 120 V 0,75 A / 240 V (C300)	
	AC3	125 W (single-phase motor)	
	DC1	6 A / 24 V DC (see Fig. 3)	
	DC13	0,22 A / 120 V 0,1 A / 250 V (R300)	
Min. switching current		5 mA AgNi, 5 mA AgNi/Au 0,2 µm, 2 mA AgNi/Au 5 µm	
Max. inrush current		12 A	
Rated current		6 A	
Max. breaking capacity	AC1	1 500 VA	
Min. breaking capacity		0,3 W AgNi, 0,3 W AgNi/Au 0,2 µm, 0,1 W AgNi/Au 5 µm	
Contact resistance		≤ 100 mΩ	
Max. operating frequency	AC1	• at rated load	1 200 cycles/hour
		• no load	18 000 cycles/hour

Coil data

Rated voltage	50/60 Hz AC	6 ... 240 V
	DC	5 ... 220 V
Must release voltage		AC: ≥ 0,2 U _n DC: ≥ 0,1 U _n
Operating range of supply voltage		see Tables 1, 2
Rated power consumption	AC	1,6 VA
	DC	0,9 W

Insulation according to PN-EN 60664-1

Insulation rated voltage		250 V AC
Rated surge voltage		2 500 V 1,2 / 50 µs
Overtoltage category		II
Insulation pollution degree		2
Dielectric strength	• between coil and contacts	2 500 V AC type of insulation: basic
	• contact clearance	1 500 V AC type of clearance: micro-disconnection
	• pole - pole	2 000 V AC type of insulation: basic
Contact - coil distance	• clearance	≥ 1,6 mm
	• creepage	≥ 3,2 mm

General data

Operating / release time (typical values)		AC: 10 ms / 8 ms	DC: 13 ms / 3 ms
Electrical life	• resistive AC1	≥ 10 ⁵ 6 A, 250 V AC	
	• cos φ	see Fig. 2	
Mechanical life (cycles)		≥ 2 x 10 ⁷	
Dimensions (L x W x H)		27,5 x 21,2 x 35,6 mm ❶	27,5 x 21,1 x 33,5 mm ❷
		27,5 x 21,2 x 33 mm ❸	
Weight		35 g	
Ambient temperature	• storage	-40...+85 °C	
	• operating	AC: -40...+55 °C	DC: -40...+70 °C
Cover protection category		IP 40	PN-EN 60529
Environmental protection		RTI	PN-EN 116000-3
Shock resistance	(NO/NC)	10 g / 5 g	
Vibration resistance		5 g 10...150 Hz	
Solder bath temperature		max. 270 °C	
Soldering time		max. 5 s	

The data in bold type pertain to the standard versions of the relays.

❶ For plug-in sockets version: standard (WT) ❷ For PCB version ❸ For version with threaded bolt

Coil data - DC voltage version

Table 1

Coil code	Rated voltage V DC	Coil resistance (± 10%) at 20 °C Ω	Coil operating range V DC	
			min. (at 20 °C)	max. (at 55 °C)
1005	5	28	4,0	5,5
1006	6	40	4,8	6,6
1012	12	160	9,6	13,2
1024	24	640	19,2	26,4
1048	48	2 600	38,4	52,8
1060	60	4 000	48,0	66,0
1080	80	7 100	64,0	88,0
1110	110	13 600	88,0	121,0
1125	125	16 000	100,0	137,5
1220	220	54 000	176,0	242,0

The data in bold type pertain to the standard versions of the relays.

Coil data - AC 50/60 Hz voltage version

Table 2

Coil code	Rated voltage V AC	Coil resistance (± 10%) at 20 °C Ω	Coil operating range V AC	
			min. (at 20 °C)	max. (at 55 °C)
5006	6	9,8	4,8	6,6
5012	12	39,5	9,6	13,2
5024	24	158,0	19,2	26,4
5042	42	470,0	33,6	46,2
5048	48	640,0	38,4	52,8
5060	60	930,0	48,0	66,0
5080	80	1 720,0	64,0	88,0
5110	110	3 450,0	88,0	121,0
5115	115	3 610,0	92,0	127,0
5120	120	3 770,0	96,0	132,0
5127	127	4 000,0	101,6	139,0
5220	220	15 400,0	176,0	242,0
5230	230	16 100,0	184,0	253,0
5240	240	16 800,0	192,0	264,0

The data in bold type pertain to the standard versions of the relays.

Dimensions - plug-in version (WT), with lockable front test button type T

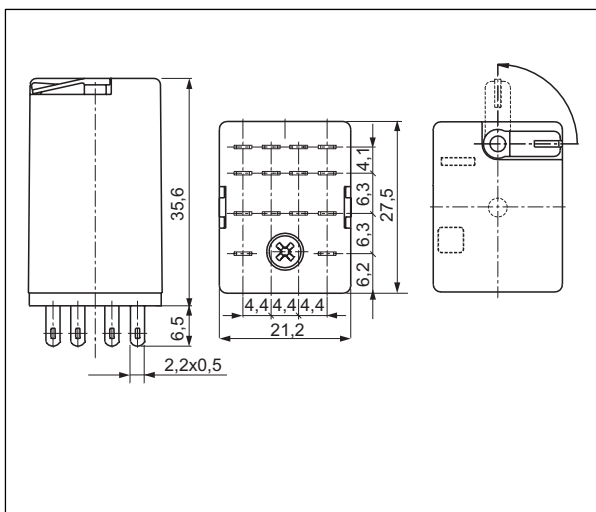

Dimensions - plug-in version, with test button (no latching) or with plug (no manual operation)

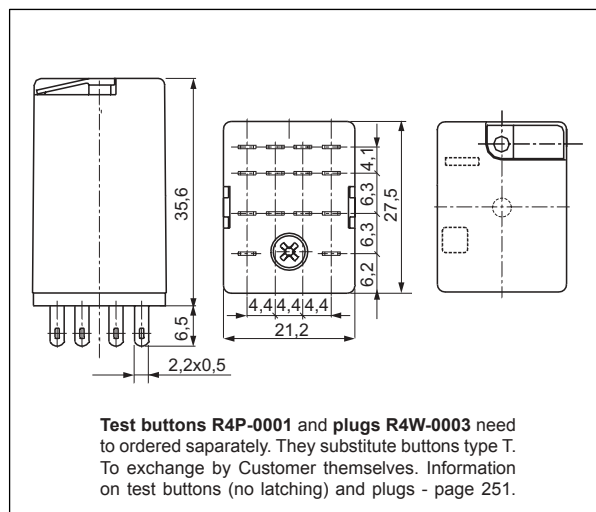

Dimensions - PCB version (without WT)

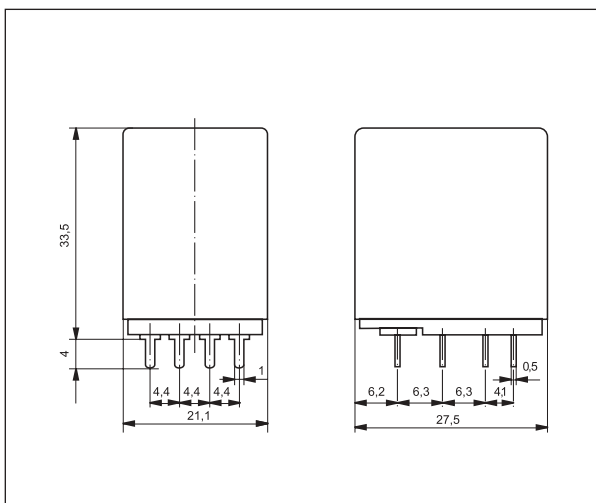

Dimensions - version with threaded bolt

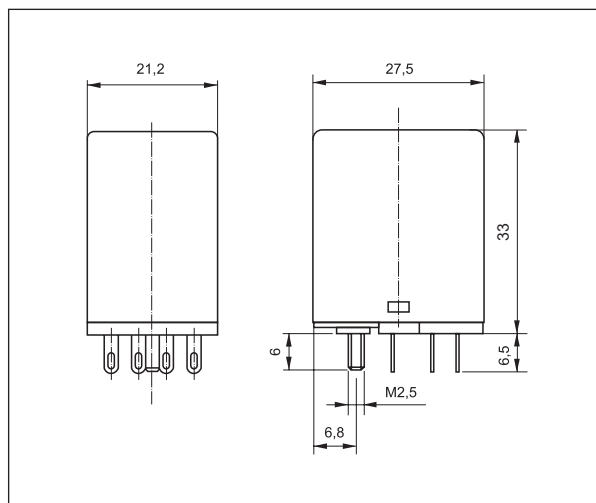

Mounting

Relays R4 are offered in versions: • standard WT (mechanical indicator + lockable front test button), for plug-in sockets. In standard version of relays (WT) is possibility self-exchange of button type T for test button R4P-0001 (no latching) or plug R4W-0003 (no manual operation). Test buttons (no latching) and plugs need to be ordered separately • for PCB (without WT) • with threaded bolt.

Connection diagram (pin side view)

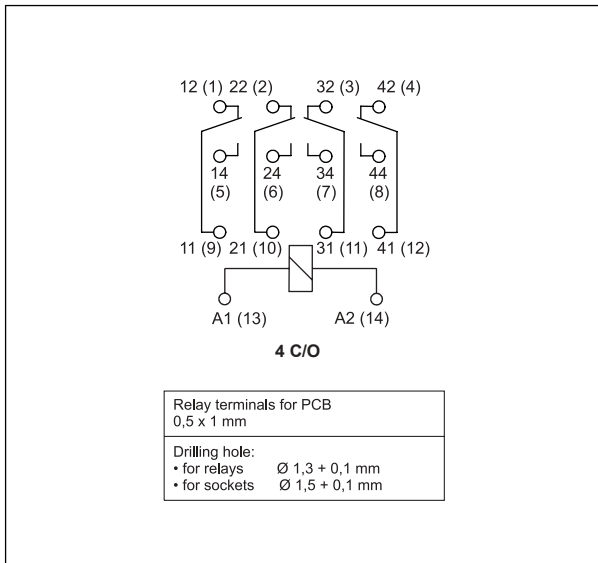

Electrical life at AC resistive load. Switching frequency: 1 200 cycles/hour

Fig. 1

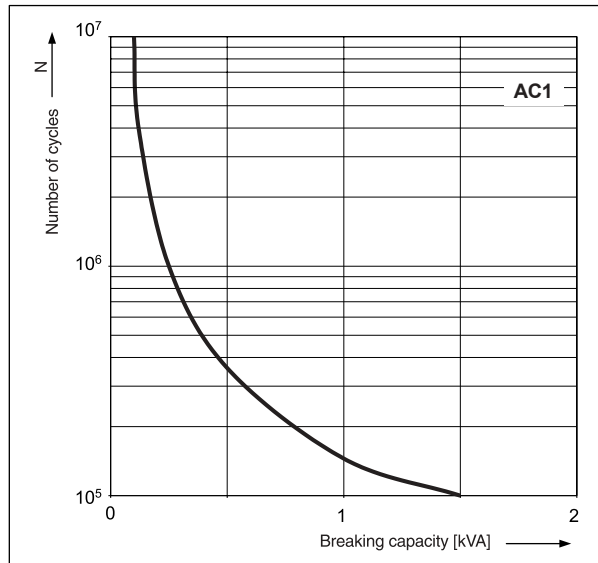

Electrical life reduction factor at AC inductive load

Fig. 2

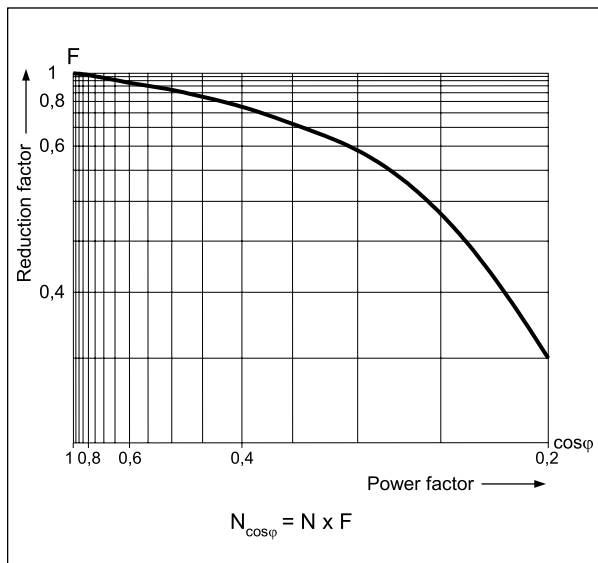

Max. DC breaking capacity A - resistive load DC1 B - inductive load L/R = 40 ms

Fig. 3

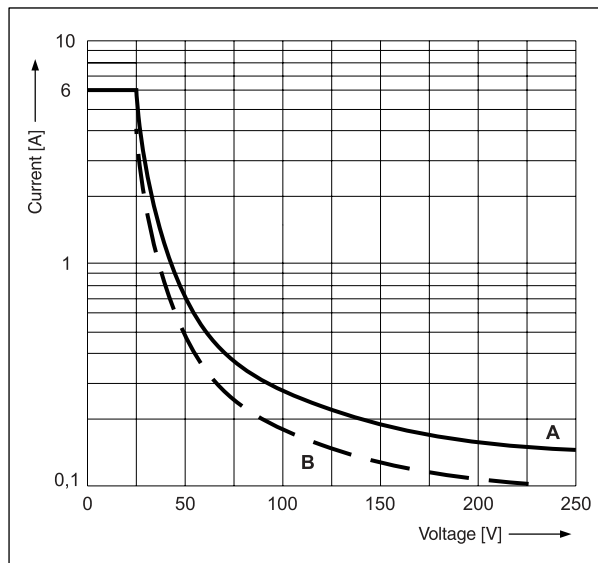

Mounting

Relays **R4** are designed for: • screw terminals plug-in sockets **GZT4** ① and **GZM4** ① with clip **GZT4-0040** or **G4 1052**, 35 mm rail mount acc. to PN-EN 60715 or on panel mounting with two M3 screws. Signalling / protecting modules **type M...** are available with sockets (see page 250) • screw terminals plug-in sockets **GZ4** with clip **G4 1052** or plug-in sockets **GS4** with clip **GS4-0036**, 35 mm rail mount acc. to PN-EN 60715 or on panel mounting with two M3 screws • plug-in sockets for PCB mounting **SU4D** with clip **G4 1053 (WT)** or **G4 1050 (without WT)** • solder terminals sockets **SU4L** with clip **G4 1053 (WT)** or **G4 1050 (without WT)** and spring clamp **G4 1040** • solder terminals sockets **G4** with clip **G4 1053 (WT)** or **G4 1050 (without WT)** • direct PCB mounting.

① Plug-in sockets **GZT4** and **GZM4** may be linked with interconnection strip type **ZGGZ4** (see page 262).

Contact material selection for different load types

- **AgNi** - for resistive or inductive loads,
- **AgNi/Au 0,2 µm** - contact surface protection against oxidation during storage,
- **AgNi/Au 5 µm** - for small resistive loads in control circuits.

Ordering codes

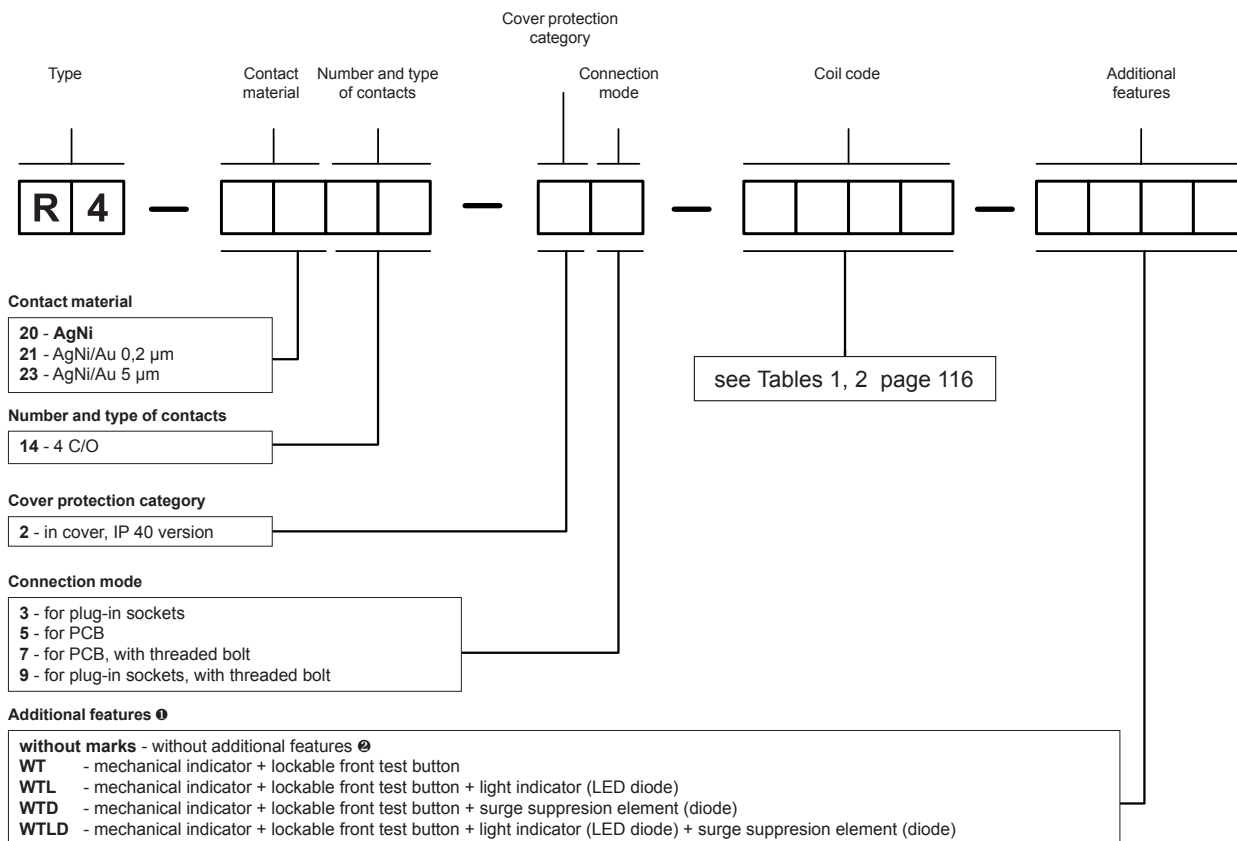

① WT - standard features of relays for plug-in sockets. **WTD, WTLD** - only for DC coils

② Refer relays for PCB and with threaded bolt

Test buttons (no latching) and plugs need to be ordered separately. They substitute buttons type T. To be exchanged by the customer themselves.

Information on test buttons (no latching) and plugs - page 251.

- Button R4P-0001-A - orange colour (AC coils)
- Button R4P-0001-D - green colour (DC coils)
- Plug R4W-0003-A - orange colour (AC coils)
- Plug R4W-0003-D - green colour (DC coils)

Note:

For relays with DC coils and additional features inclusive: **D** - surge suppression element (diode) and **L** - light indicator (LED diode) coil supply polarization is fixed. Terminal A1 (13) "+"; terminal A2 (14) "-". Supply polarization is marked on relay cover. Colour of lockable front test button type T represents type of coil supply current: orange - AC coil, green - DC coil.

Example of ordering code:

R4-2014-23-5230-WTL relay **R4**, contact material AgNi, with four changeover contacts, in cover IP 40, for plug-in sockets, voltage version 230 V AC 50/60 Hz, with mechanical indicator and lockable front test button and light indicator (LED diode)

Plug-in sockets and accessories for relays R4

GZT4 ⑥

For R4, T-R4

Screw terminals
Maximum screw torque: 0,7 Nm
35 mm rail mount acc. to PN-EN 60715
or on panel mounting
76,3 x 27 x 42,5(80) mm ②
Four poles
6 A, 300 V AC



Connection diagram

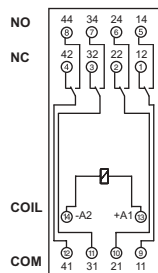

Dimensions

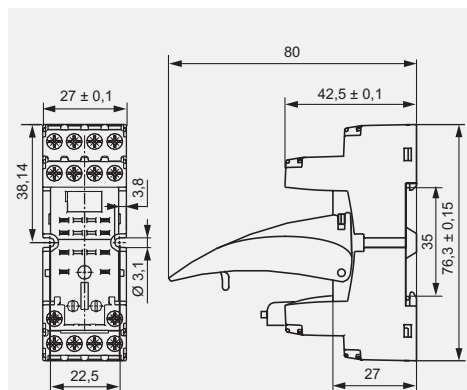

Accessories ① ⑦

GZM4

For R4, T-R4

Screw terminals
Maximum screw torque: 0,7 Nm
35 mm rail mount acc. to PN-EN 60715
or on panel mounting
75 x 27 x 61(82) mm ②
Four poles
6 A, 300 V AC

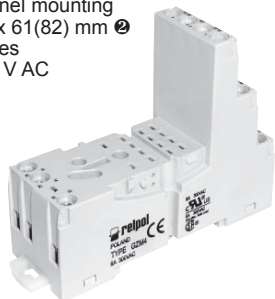

Connection diagram

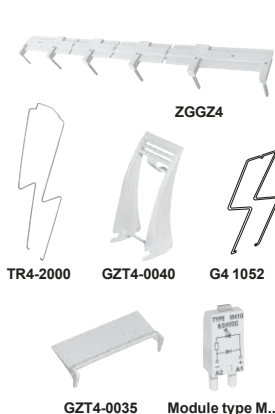
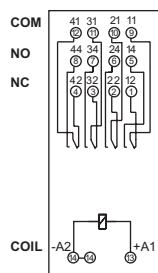

Dimensions

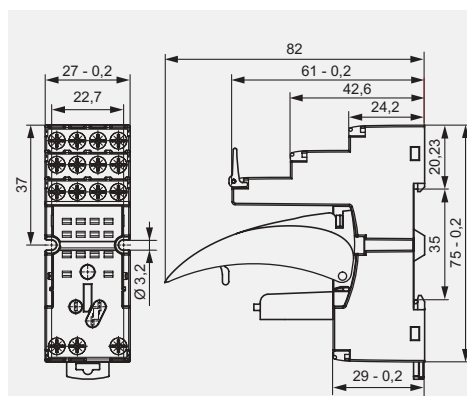

Accessories ① ⑦

GZ4

For R4

Screw terminals
Maximum screw torque: 0,7 Nm
35 mm rail mount acc. to PN-EN 60715
or on panel mounting
66,4 x 29,5 x 29 mm
Four poles
10 A, 300 V AC

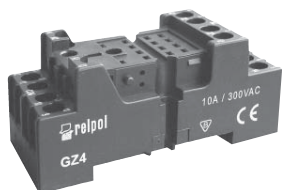

Connection diagram

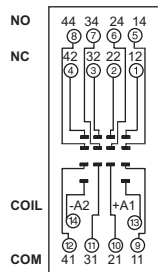

Dimensions

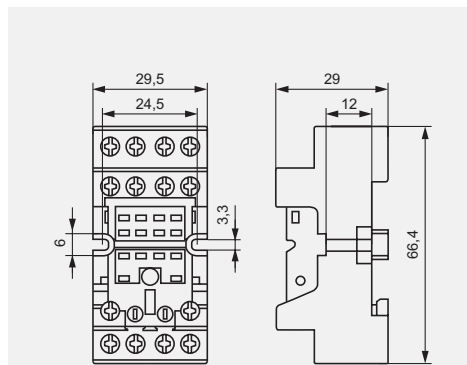

Accessories

G4 1052

GS4

For R4

Screw terminals
Maximum screw torque: 0,7 Nm
35 mm rail mount acc. to PN-EN 60715
or on panel mounting
67 x 30,8 x 30(~63,7) mm ③
Four poles
6 A, 300 V AC

NEW product

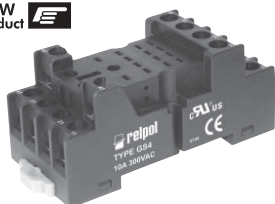

Connection diagram

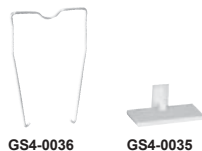
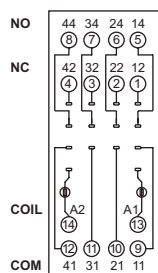

Dimensions

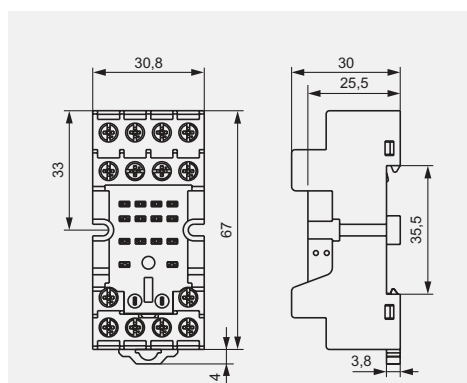

Accessories

GS4-0036

GS4-0035

① "Mounting and sub-assemblies of accessories in the socket" and "Signalling / protecting modules type M..." - see www.repol.com.pl - Product Guide - Type of relay - Additional information. ② In the bracket the height of socket with retainer / retractor clip is shown. ③ Have obtained LR Type Approval Certificate (Lloyd's Register). ⑦ For R4 relays: G4 1052, GZT4-0040, GZT4-0035, module type M...; for T-R4 relays: TR4-2000, GZT4-0035

Plug-in sockets and accessories for relays R4

SU4D

For R4
For PCB
29,6 x 21,5 x 11 mm
Four poles
6 A, 250 V AC

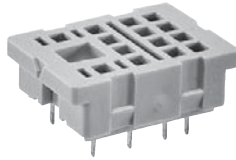

Pinout

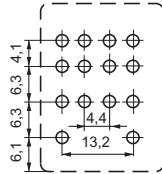

Accessories ⑤ G4 1053 G4 1050

Dimensions

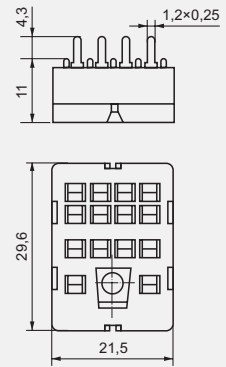

SU4L

For R4
Solder terminals
29,6 x 21,5 x 18,1 mm
Four poles
6 A, 250 V AC

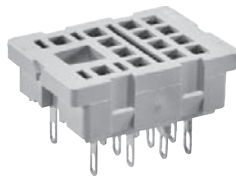

Dimensions of opening on panel mounting

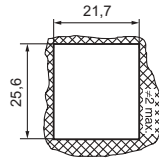

Accessories ⑤ G4 1053 G4 1050 G4 1040

Dimensions

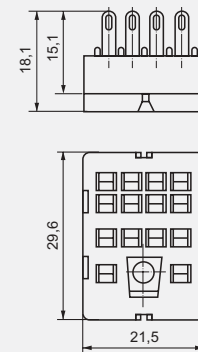

G4

For R4
Solder terminals
40,5 x 21,5 x 18,1 mm
Four poles
6 A, 250 V AC

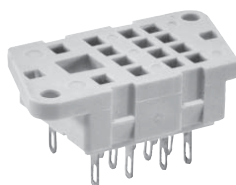

Pinout of openings on panel mounting

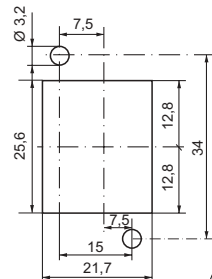

Accessories ⑤ G4 1053 G4 1050

Dimensions

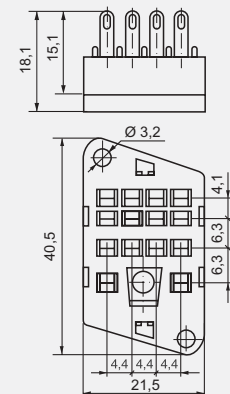

⑤ G4 1053 - for R2...WT, R4...WT relays; G4 1050 - for R2, R4 without WT