



LA4555

2-Channel AF Power Amplifier for Radio, Tape Recorder Use

Features

- Low quiescent current.
- On-chip 2 channels permitting use in stereo and bridge amplifier applications.
- High output.
- Minimum number of external parts required.
(9 pcs. minimum)
- Good ripple rejection (at steady state).
- Soft tone at the output saturation mode.
- Good channel separation.
- Easy thermal design.
- Small pop noise at the time of power supply ON/OFF.

Package Dimensions

unit:mm

3022A-DIP12F

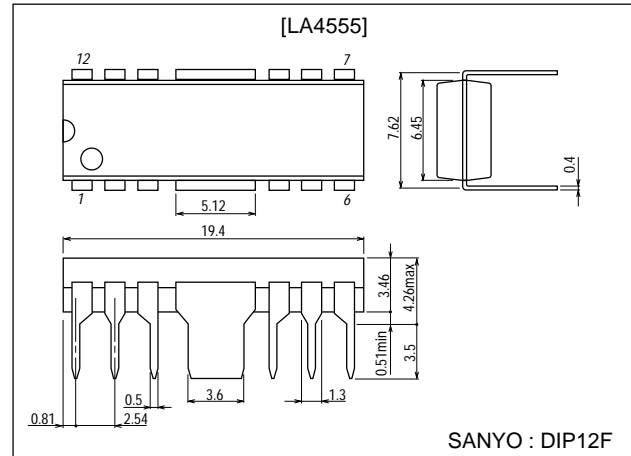

Specifications

Absolute Maximum Ratings at $T_a = 25^\circ\text{C}$

Parameter	Symbol	Conditions	Ratings	Unit
Maximum supply voltage	$V_{CC\text{ max}}$		13	V
Allowable power dissipation	$P_d\text{ max}$	With recommended PCB (See sample printed circuit pattern.)	4	W
Operating temperature	T_{opr}		-20 to +75	$^\circ\text{C}$
Storage temperature	T_{stg}		-55 to +150	$^\circ\text{C}$

Operating Conditions at $T_a = 25^\circ\text{C}$

Parameter	Symbol	Conditions	Ratings	Unit
Recommended supply voltage	V_{CC}		6, 9	V
Load resistance	R_L	Stereo 6V	2 to 8	Ω
		BTL 6V	4 to 8	Ω
		Stereo 9V	4 to 8	Ω
		BTL 9V	8	Ω
Operating voltage range	V_{CCop}		3.6 to 12	V

■ Any and all SANYO products described or contained herein do not have specifications that can handle applications that require extremely high levels of reliability, such as life-support systems, aircraft's control systems, or other applications whose failure can be reasonably expected to result in serious physical and/or material damage. Consult with your SANYO representative nearest you before using any SANYO products described or contained herein in such applications.

■ SANYO assumes no responsibility for equipment failures that result from using products at values that exceed, even momentarily, rated values (such as maximum ratings, operating condition ranges, or other parameters) listed in products specifications of any and all SANYO products described or contained herein.

SANYO Electric Co., Ltd. Semiconductor Company

TOKYO OFFICE Tokyo Bldg., 1-10, 1 Chome, Ueno, Taito-ku, TOKYO, 110-8534 JAPAN

21800TN (KT)/90196RM/O147KI/5275MW, TS No.1697-1/10

LA4555

Operating Characteristics at $T_a = 25^\circ\text{C}$, $V_{CC} = 9\text{V}$, $f = 1\text{kHz}$, $R_g = 600\Omega$, $R_L = 4\Omega$, (): $R_L = 8\Omega$,

See specified Test Circuit.

Parameter	Symbol	Conditions	Ratings			Unit
			min	typ	max	
Quiescent current	I_{CCO}	Stereo 9V		15	30	mA
		Stereo 6V		13		mA
Voltage gain	VG	$R_f = 0$, $V_{IN} = -51\text{dBm}$	49	51	53	dB
Voltage gain difference	ΔVG	$R_f = 0$, $V_{IN} = -51\text{dBm}$			± 1	dB
Output power	P_O	THD=10%, 6V, Stereo	0.7	1.0		W
		THD=10%, BTL		2.8		W
		THD=10%, 9V, Stereo	1.7	2.3		W
		THD=10%, BTL		(4.5)		W
Total harmonic distortion	THD	$P_O = 250\text{mW}$		0.3	1.5	%
Input resistance	r_i		21	30		k Ω
Output noise voltage	V_{NO}	$R_g = 0$		0.5	1.0	mV
		$R_g = 10\text{k}\Omega$		0.8	2.0	mV
Ripple rejection	R_r	$R_g = 0$, $f = 100\text{Hz}$, $V_R = 150\text{mV}$	40	48		dB
Crosstalk	CT	$R_g = 10\text{k}\Omega$, $f = 1\text{kHz}$, $V_o = 0\text{dBm}$	40	58		dB

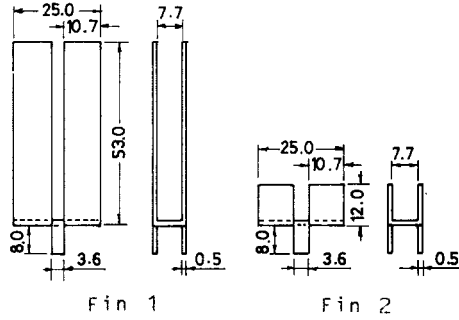
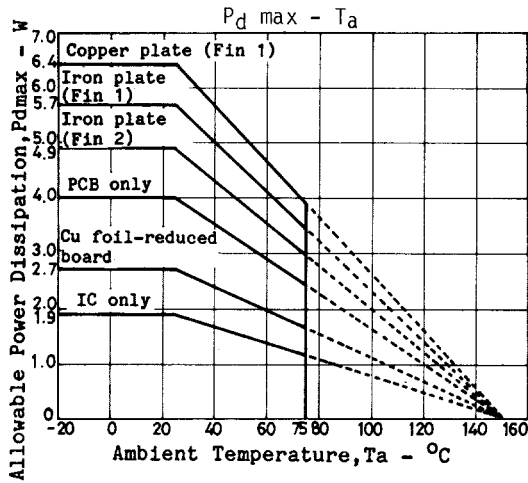

Equivalent Circuit Block Diagram

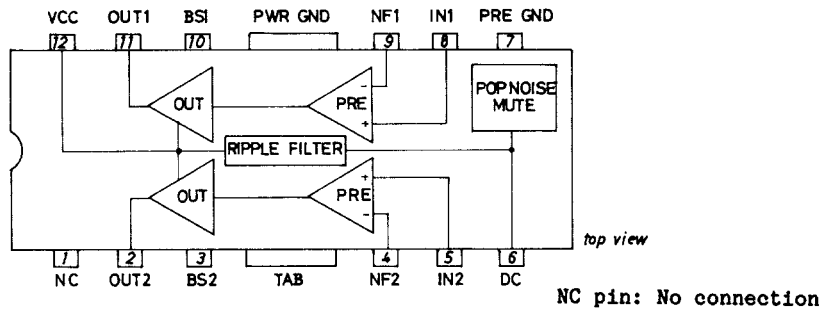

Sample Application Circuit : Stereo Use

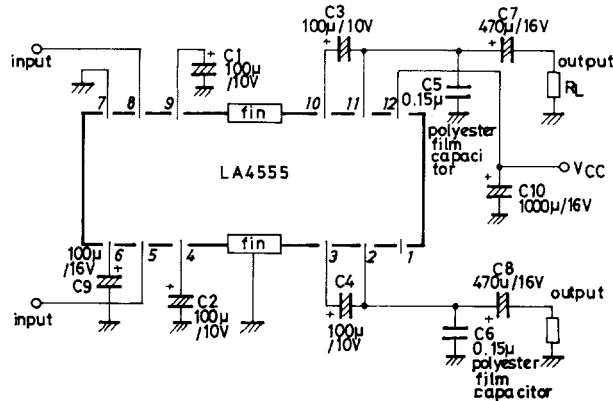

LA4555

Sample Printed Circuit Pattern (Cu-foiled side)

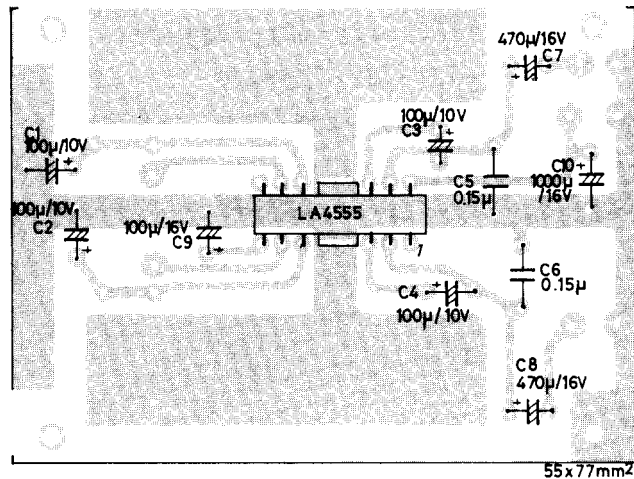

Sample Application Circuit : Bridge Amplifier Use 1

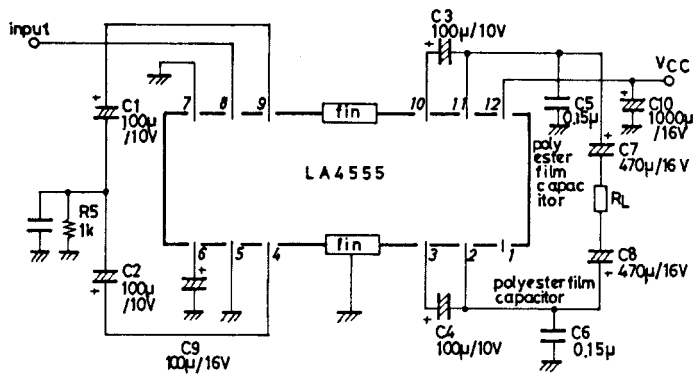

Sample Application Circuit : Bridge Amplifier Use 2

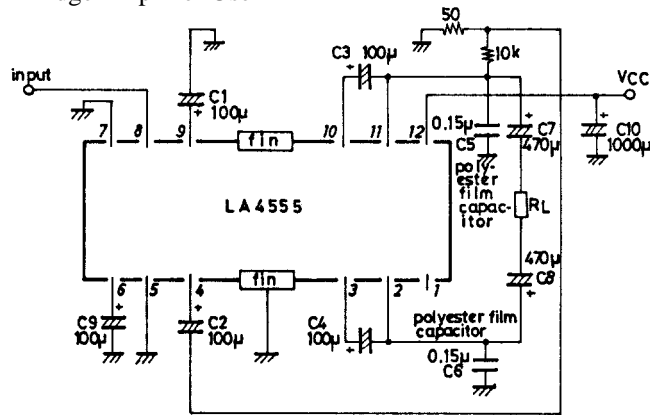

Description of External Parts

C1 (C2) : Feedback capacitor. The low cutoff frequency is determined by the following formula.

$$f_L = \frac{1}{2\pi C_1 R_f}$$

f_L : Low cutoff frequency
R_f : Feedback resistance

Since this capacitor as well as decoupling capacitor affects the starting time, the capacitor value must be fixed with the necessary low frequency band fully considered.

C3 (C4) : Bootstrap capacitor. The output at low frequencies depends on this capacitor. Decreasing the capacitor value lowers the output at low frequencies. A capacitor value of 47µF or more is required.

C5 (C6) : Oscillation blocking capacitor. Use a polyester film capacitor that is good in high frequency response and temperature characteristic. The use of an electrolytic capacitor, ceramic capacitor may cause oscillation to occur at low temperatures.

Continued on next page.

Continued from preceding page.

C7 (C8) : Output capacitor. The low cutoff frequency is determined by the following formula.

$$f_L = \frac{1}{2\pi C7 R_L}$$

f_L : Low cutoff frequency
 R_L : Load resistance

To make the low frequency response in the bridge amplifier mode identical with that in the stereo mode, the capacitor value must be doubled.

C9 : Decoupling capacitor. Used for the ripple filter. Since the rejection effect is saturated at a certain capacitor value, it is meaningless to increase the capacitor value more than needed. This capacitor, being also used for the time constant of the muting circuit, affects the starting time.

C10 : Power source capacitor.

Application Circuits

Voltage gain adjust

· Stereo mode

The voltage gain is determined by on-chip resistor R1 (R2) and external feedback resistor Rf as follows :

$$VG = 20 \log \frac{R1}{Rf1 + R2} \text{ [dB]}$$

Any voltage gain can be obtained by external resistor Rf.

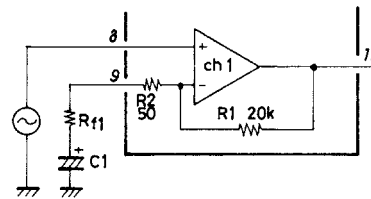

· Bridge amplifier 1 mode

Since point (A) is at the same potential as Vi and point (B) is a virtual GND point,

$$Vo1 \approx \frac{R1}{R2 + R4 + Rf1 + Rf2} Vi$$

$$Vo2 \approx \frac{-R3}{R2 + R4 + Rf1 + Rf2} Vi$$

$$Vo = Vo1 - Vo2 = \frac{R1 + R3}{R2 + R4 + Rf1 + Rf2} Vi$$

$$VG = 20 \log \frac{Vo}{Vi} = 20 \log \frac{R1 + R3}{R2 + R4 + Rf1 + Rf2} \text{ [dB]}$$

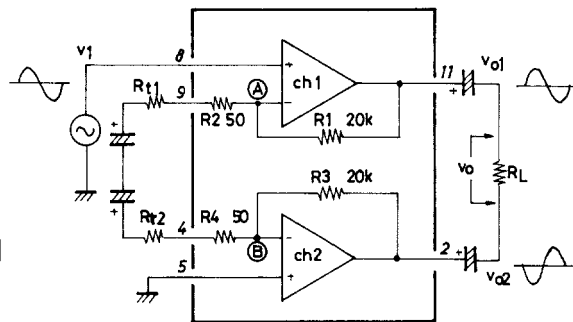

Assuming R2=R4=50Ω, R1=R3=20kΩ and Rf1=Rf2, the voltage gain is obtained by :

$$VG = 20 \log \frac{R1}{Rf1 + R2} \text{ [dB]}$$

· Bridge amplifier 2 mode

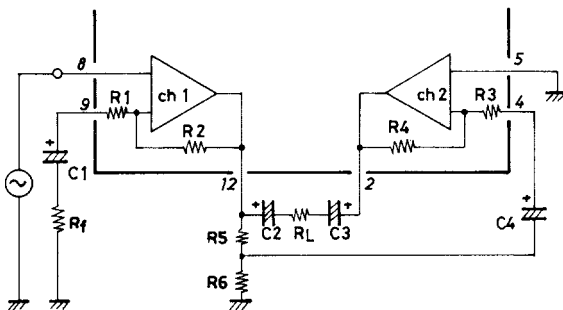

The CH1 is a noninverting amplifier and the CH2 is an inverting amplifier. The total voltage gain, being apparently higher than that of the CH1 by 6dB, is approximately calculated by the following formula.

$$VG = 20 \log \frac{R2}{R1} + 6 \text{ (dB)}$$

To reduce the voltage gain, Rf is connected and the following formula is used.

$$VG = 20 \log \frac{R2}{Rf + R1} + 6 \text{ (dB)}$$

Proper Cares in Using LA4555-Applied Set

1. If the transformer regulation is not as specified, the supply voltage drops momentarily when the motor is an AC-powered set is turned ON. In this case, hum noise may be generated. So, be careful of the transformer regulation.

2. DC muting

To apply DC muting by controlling the NF pin, it is recommended to use the circuit configuration shown right. The potential at point(A) is set to 3.5 to 4V.

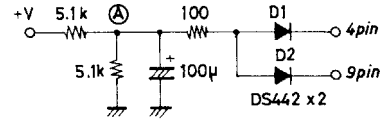

3. Pop noise

If pop noise generated at the time of power ON/OFF disturbs you, connect a resistor of approximately 620Ω across the middle point and GND.

4. Slider contact noise of variable resistor

Since the input circuit uses PNP transistors, no input coupling capacitor is required. However, if slider contact noise of the variable resistor presents any problem, connect a capacitor in series with input.

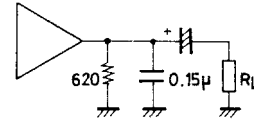

Thermal Design

Since the DIP-12F package is such that the Cu-foiled area of the printed circuit board is used to dissipate heat, make the Cu-foiled area in the vicinity of the heat sink of the IC as large as possible when designing the printed circuit board. The use of the Cu-foiled area indicated by shading in the above-mentioned sample printed circuit pattern makes it possible to dissipate more heat. Power dissipation Pd is increased depending on the supply voltage and load. So, it is recommended to use the printed circuit board together with the heat sink. The following is a formula to be used to calculate Pd (for stereo use). For AC power supply, however, it is recommended to actually measure Pd on the transformer of each set. For bridge amplifier use, Pd is calculated at 1/2 of the load.

(1) DC power supply

$$Pd \max = \frac{V_{CC}^2}{\pi^2 R_L} + I_{cco} \cdot V_{CC} \quad (\text{For stereo use}) \dots (1)$$

(2) AC power supply

- V_{CC2} : Supply voltage at quiescent mode
- $V_{CC} (Pd)$: Supply voltage at Pd max
- V_{CC1} : Supply voltage at maximum output
- r : Voltage regulation $\frac{V_{CC2} - V_{CC1}}{V_{CC1}}$

I_{cco} : Quiescent current

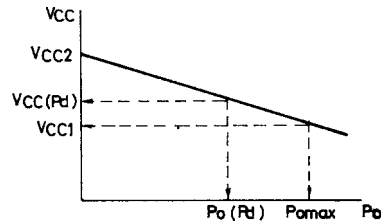

$$Pd \max = \frac{V_{CC}(Pd)^2}{\pi^2 R_L} + I_{cco} \cdot V_{CC} (Pd) \quad (\text{For stereo use}) \dots (2)$$

where

$$V_{CC} (Pd) = \frac{(1+r) V_{CC1}}{1 + \frac{r \cdot V_{CC1}}{\sqrt{2} \cdot \pi \cdot R_L} \times \sqrt{\frac{R_L}{Po \max}}}$$

Example of Heat Sink Mounting Method

The heat sink must be of such a shape as to be able to dissipate heat from the IC plastic area and fin area and is soldered to the printed circuit board as shown below. For the size of the heat sink, refer to the Pd – Ta characteristic. The material of the heat sink is recommended to be copper or iron which is solderable. It is recommended to apply silicone grease to the IC plastic area to reduce thermal resistance between the heat sink and the IC plastic area.

Example of Heat Sink Mounting

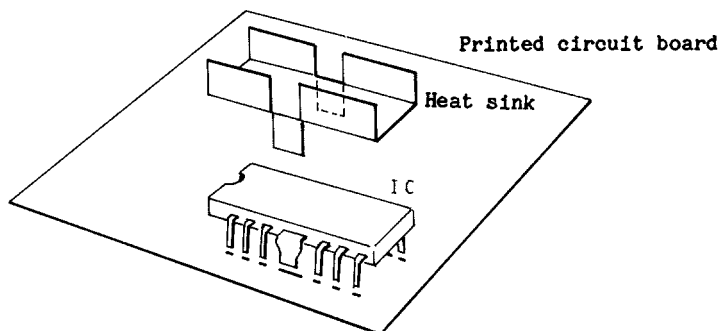

LA4555

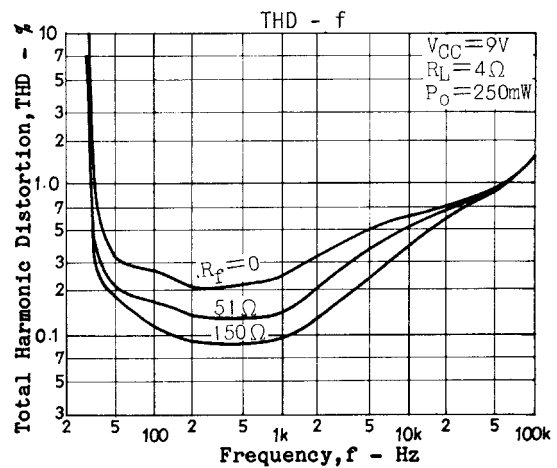
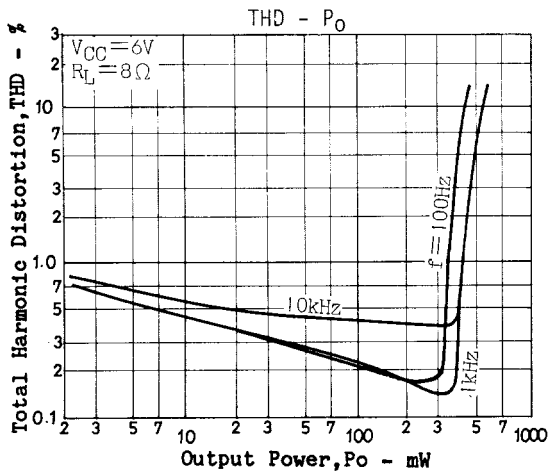
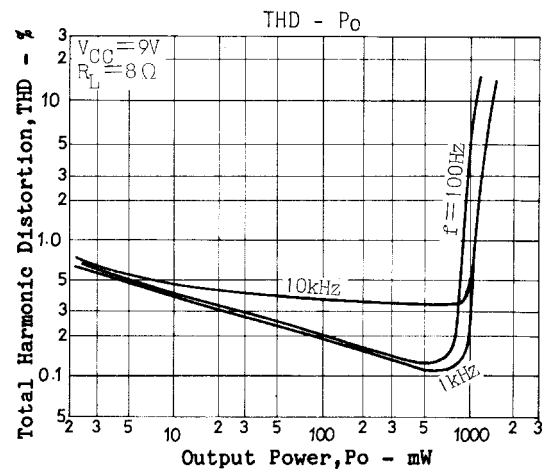
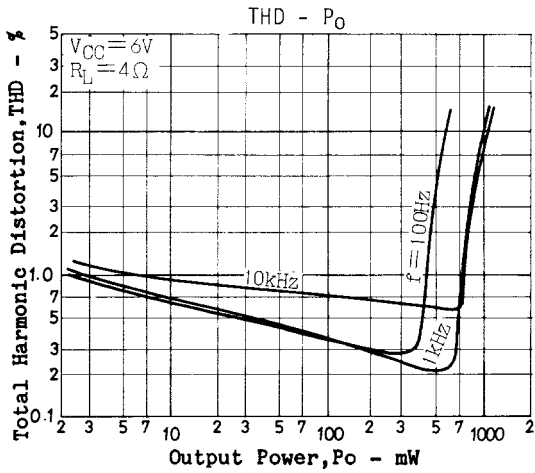
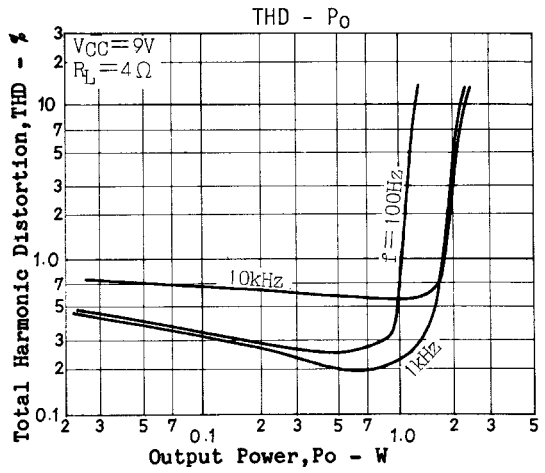
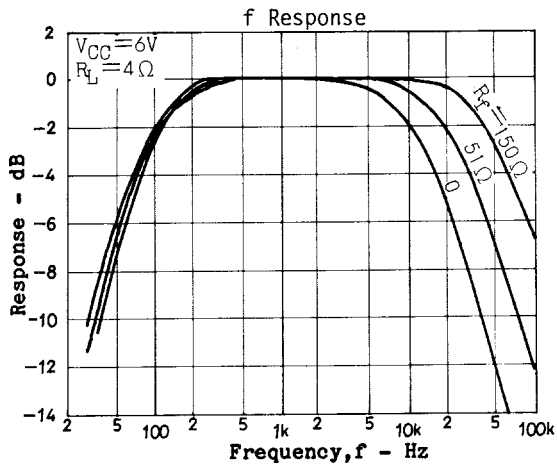
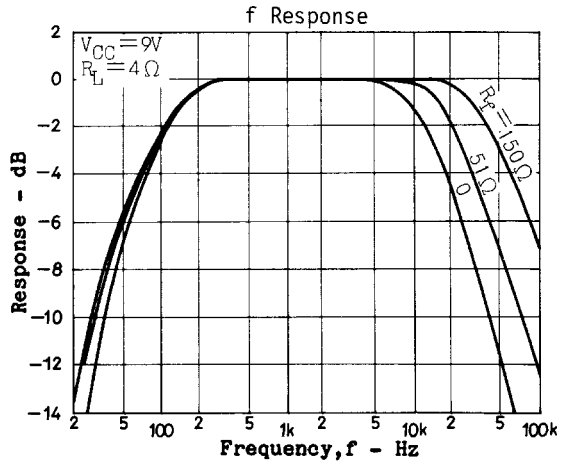
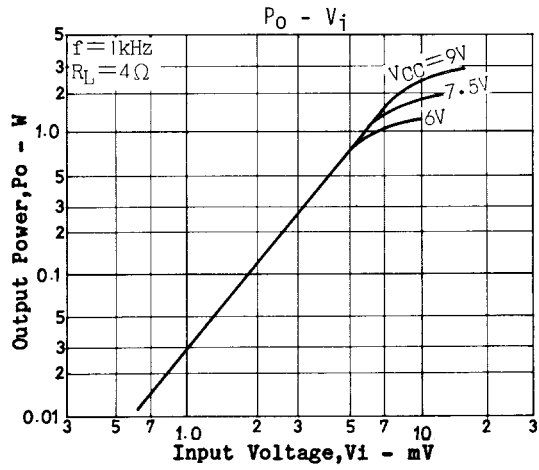

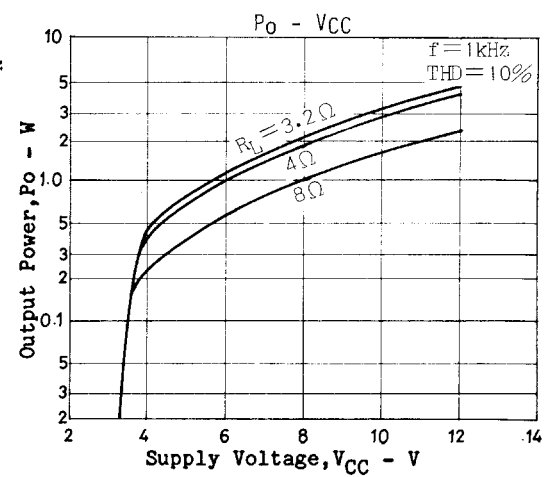
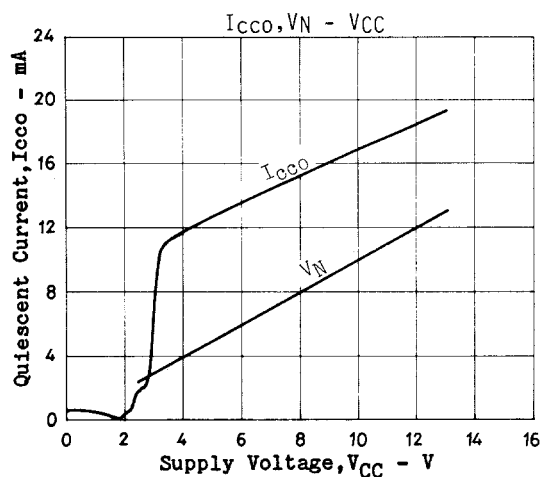
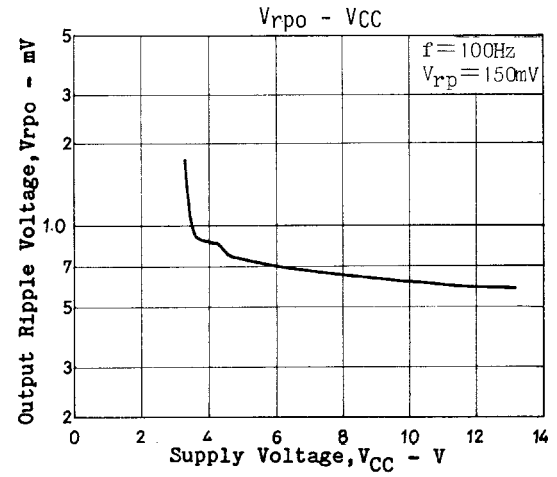
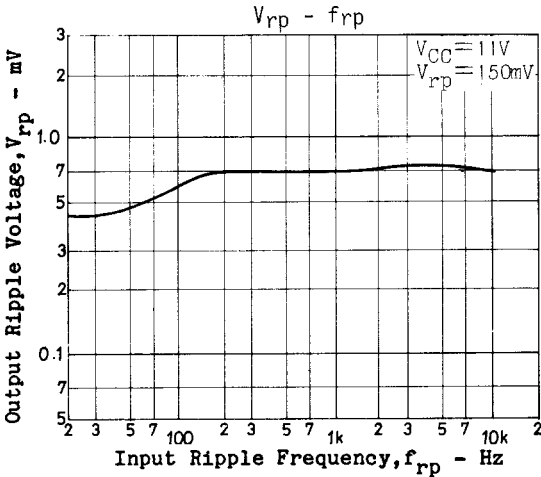
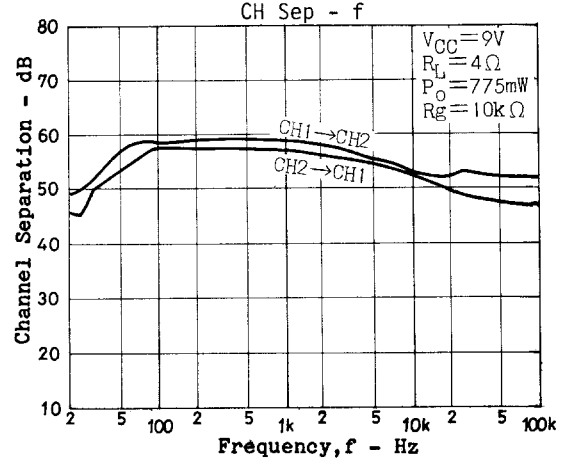
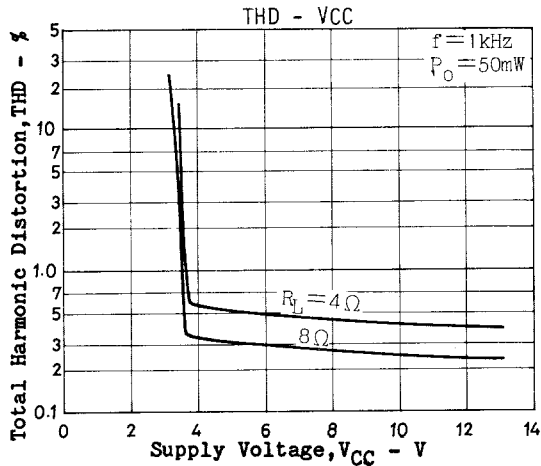
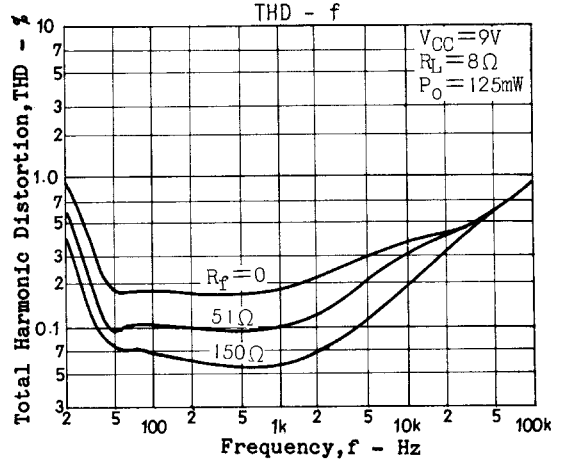
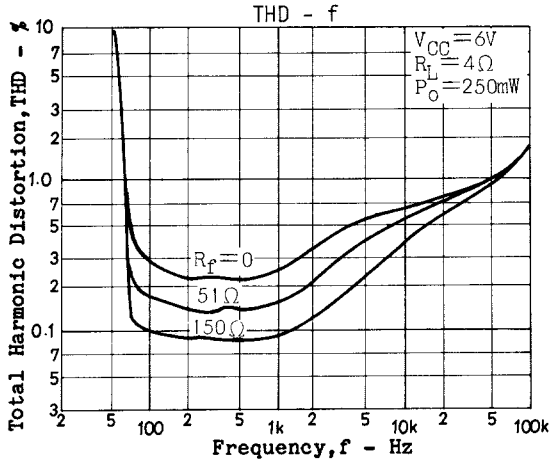

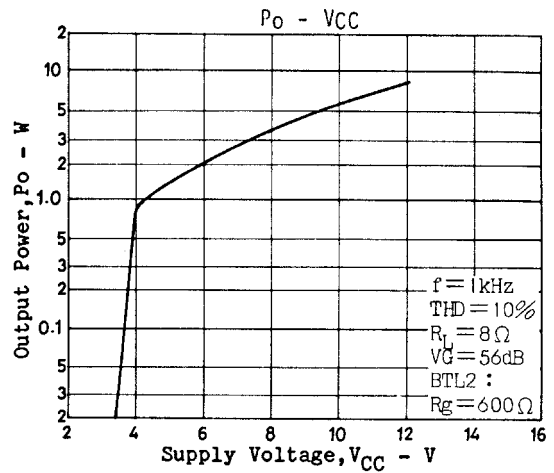
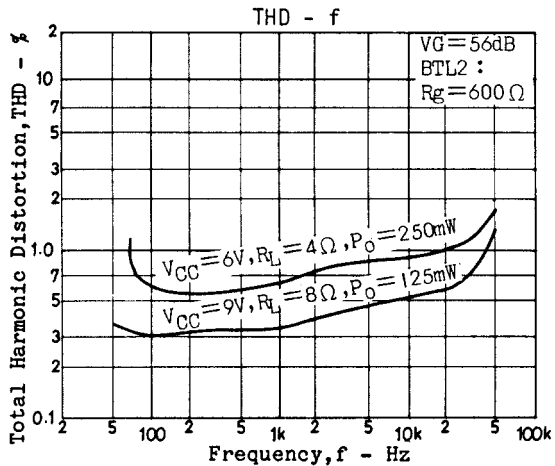
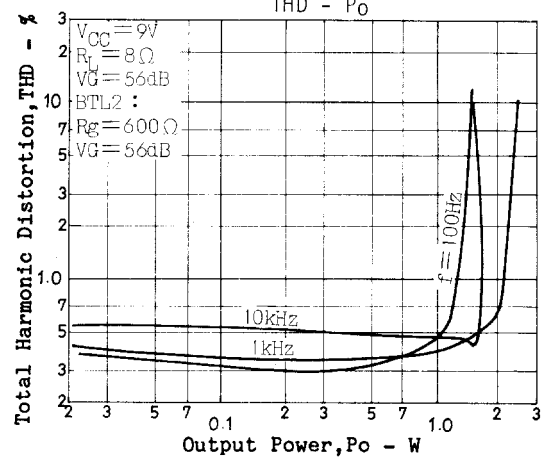
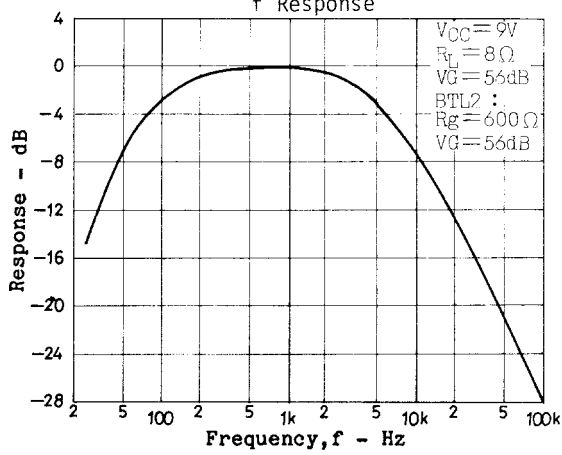
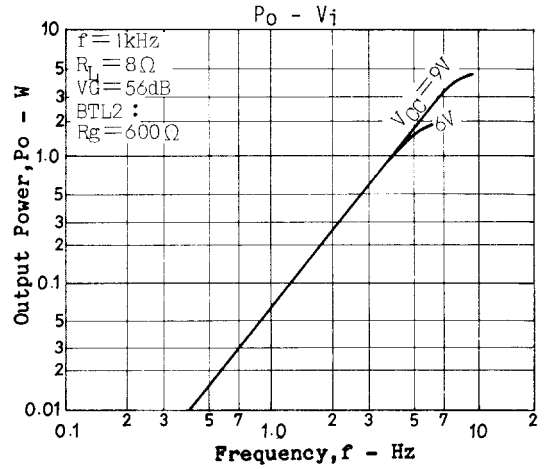
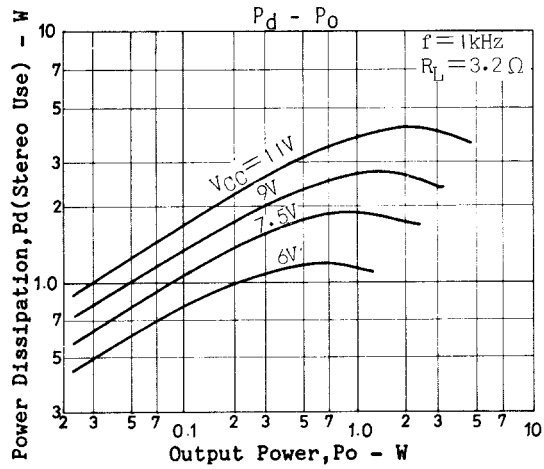
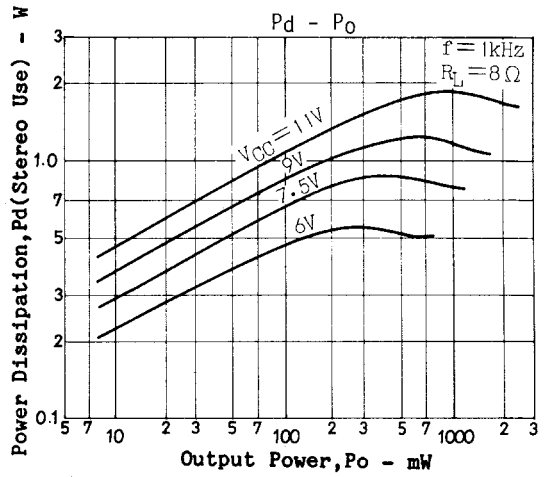
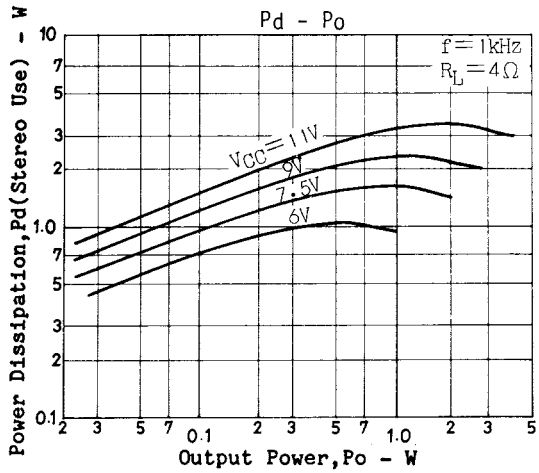

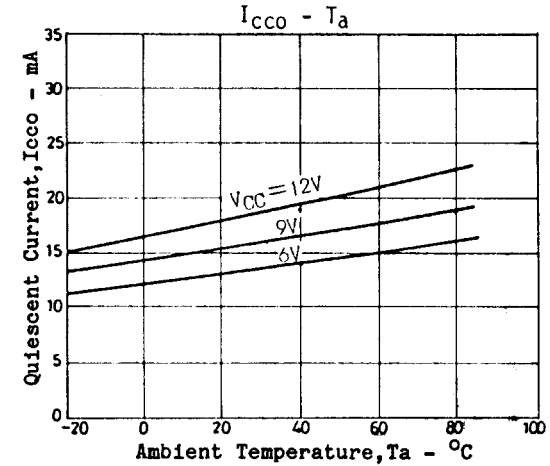
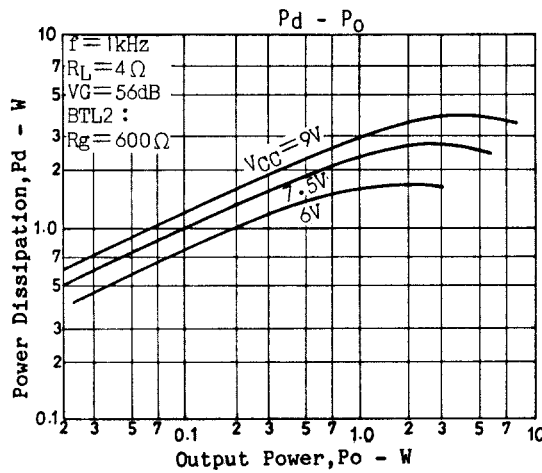
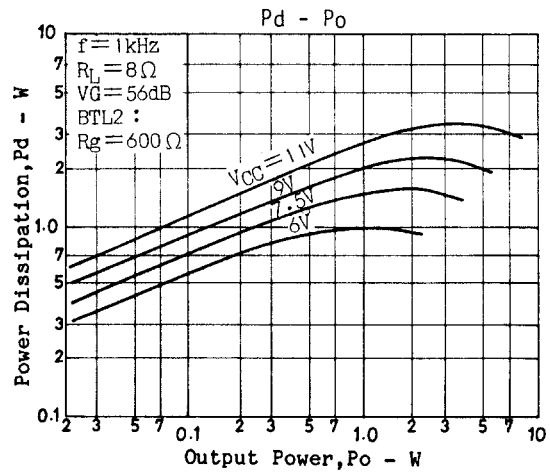
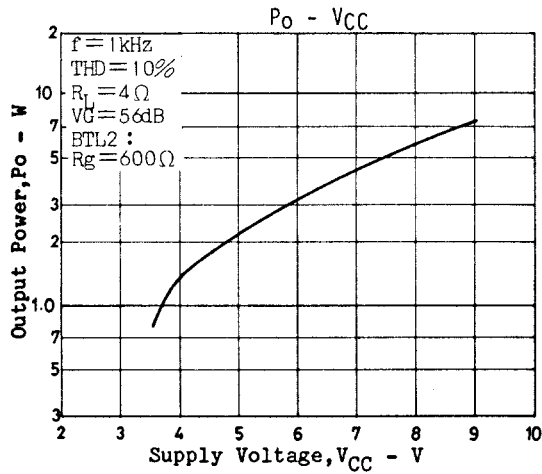

Proper Cares in Using IC

1. If the IC is used in the vicinity of the maximum ratings, even a slight variation in conditions may cause the maximum ratings to be exceeded, thereby leading to breakdown. Allow an ample margin of variation for supply voltage, etc. and use the IC in the range where the maximum ratings are not exceeded.
2. Pin-to-pin short : If power is applied when the space between pins is shorted, breakdown or deterioration may occur.
 When mounting the IC on the board and applying power, make sure that the space between pins is not shorted with solder, etc.
3. Load short : If the IC is used with the load shorted for a long time, breakdown or deterioration may occur. Be sure not to short the load.
4. When the IC is used in radios or radio cassette tape recorders, keep a good distance between IC and bar antenna.
5. When making the board, refer to the sample printed circuit pattern.
6. It should be noted that some plug jacks to be used for connecting to the external speaker are such that both poles are shorted once when connecting.

- Specifications of any and all SANYO products described or contained herein stipulate the performance, characteristics, and functions of the described products in the independent state, and are not guarantees of the performance, characteristics, and functions of the described products as mounted in the customer's products or equipment. To verify symptoms and states that cannot be evaluated in an independent device, the customer should always evaluate and test devices mounted in the customer's products or equipment.
- SANYO Electric Co., Ltd. strives to supply high-quality high-reliability products. However, any and all semiconductor products fail with some probability. It is possible that these probabilistic failures could give rise to accidents or events that could endanger human lives, that could give rise to smoke or fire, or that could cause damage to other property. When designing equipment, adopt safety measures so that these kinds of accidents or events cannot occur. Such measures include but are not limited to protective circuits and error prevention circuits for safe design, redundant design, and structural design.
- In the event that any or all SANYO products(including technical data, services) described or contained herein are controlled under any of applicable local export control laws and regulations, such products must not be exported without obtaining the export license from the authorities concerned in accordance with the above law.
- No part of this publication may be reproduced or transmitted in any form or by any means, electronic or mechanical, including photocopying and recording, or any information storage or retrieval system, or otherwise, without the prior written permission of SANYO Electric Co., Ltd.
- Any and all information described or contained herein are subject to change without notice due to product/technology improvement, etc. When designing equipment, refer to the "Delivery Specification" for the SANYO product that you intend to use.
- Information (including circuit diagrams and circuit parameters) herein is for example only ; it is not guaranteed for volume production. SANYO believes information herein is accurate and reliable, but no guarantees are made or implied regarding its use or any infringements of intellectual property rights or other rights of third parties.

This catalog provides information as of February, 2000. Specifications and information herein are subject to change without notice.