

SIPMOS® Power Transistor

- N channel
- Enhancement mode
- Logic Level
- Avalanche-rated
- dv/dt rated
- 175°C operating temperature
- also in SMD available



Pin 1	Pin 2	Pin 3
G	D	S

Type	V _{DS}	I _D	R _{DS(on)}	Package	Ordering Code
BUZ 102 SL	55 V	47 A	0.028 Ω	TO-220 AB	Q67040-S4010-A2

Maximum Ratings

Parameter	Symbol	Values	Unit
Continuous drain current <i>T_C</i> = 25 °C <i>T_C</i> = 100 °C	<i>I_D</i>	47 33	A
Pulsed drain current <i>T_C</i> = 25 °C	<i>I_{Dpuls}</i>	188	
Avalanche energy, single pulse <i>I_D</i> = 47 A, <i>V_{DD}</i> = 25 V, <i>R_{GS}</i> = 25 Ω <i>L</i> = 222 μH, <i>T_j</i> = 25 °C	<i>E_{AS}</i>	245	mJ
Avalanche current, limited by <i>T_{jmax}</i>	<i>I_{AR}</i>	47	A
Avalanche energy, periodic limited by <i>T_{jmax}</i>	<i>E_{AR}</i>	12	mJ
Reverse diode dv/dt <i>I_S</i> = 47 A, <i>V_{DS}</i> = 40 V, <i>di_F/dt</i> = 200 A/μs <i>T_{jmax}</i> = 175 °C	dv/dt	6	kV/μs
Gate source voltage	<i>V_{GS}</i>	± 14	V
Power dissipation <i>T_C</i> = 25 °C	<i>P_{tot}</i>	120	W

Maximum Ratings

Parameter	Symbol	Values	Unit
Operating temperature	T_j	-55 ... + 175	°C
Storage temperature	T_{stg}	-55 ... + 175	
Thermal resistance, junction - case	R_{thJC}	≤ 1.25	K/W
Thermal resistance, junction - ambient	R_{thJA}	≤ 62	
IEC climatic category, DIN IEC 68-1		55 / 175 / 56	

Electrical Characteristics, at $T_j = 25^\circ\text{C}$, unless otherwise specified

Parameter	Symbol	Values			Unit
		min.	typ.	max.	

Static Characteristics

Drain- source breakdown voltage $V_{GS} = 0 \text{ V}$, $I_D = 0.25 \text{ mA}$, $T_j = 25 \text{ }^\circ\text{C}$	$V_{(BR)DSS}$	55	-	-	V
Gate threshold voltage $V_{GS} = V_{DS}$, $I_D = 90 \text{ } \mu\text{A}$	$V_{GS(th)}$	1.2	1.6	2	
Zero gate voltage drain current $V_{DS} = 50 \text{ V}$, $V_{GS} = 0 \text{ V}$, $T_j = -40 \text{ }^\circ\text{C}$ $V_{DS} = 50 \text{ V}$, $V_{GS} = 0 \text{ V}$, $T_j = 25 \text{ }^\circ\text{C}$ $V_{DS} = 50 \text{ V}$, $V_{GS} = 0 \text{ V}$, $T_j = 150 \text{ }^\circ\text{C}$	I_{DSS}	-	-	0.1 1 100	μA
Gate-source leakage current $V_{GS} = 20 \text{ V}$, $V_{DS} = 0 \text{ V}$	I_{GSS}	-	10	100	
Drain-Source on-resistance $V_{GS} = 4.5 \text{ V}$, $I_D = 33 \text{ A}$ $V_{GS} = 10 \text{ V}$, $I_D = 33 \text{ A}$	$R_{DS(on)}$	-	0.022 0.014	0.028 0.018	Ω

Electrical Characteristics, at $T_j = 25^\circ\text{C}$, unless otherwise specified

Parameter	Symbol	Values			Unit
		min.	typ.	max.	
Dynamic Characteristics					
Transconductance $V_{DS} \geq 2 \cdot I_D \cdot R_{DS(on)max}$, $I_D = 33 \text{ A}$	g_{fs}	10	-	-	S
Input capacitance $V_{GS} = 0 \text{ V}$, $V_{DS} = 25 \text{ V}$, $f = 1 \text{ MHz}$	C_{iss}	-	1380	1730	pF
Output capacitance $V_{GS} = 0 \text{ V}$, $V_{DS} = 25 \text{ V}$, $f = 1 \text{ MHz}$	C_{oss}	-	410	515	
Reverse transfer capacitance $V_{GS} = 0 \text{ V}$, $V_{DS} = 25 \text{ V}$, $f = 1 \text{ MHz}$	C_{rss}	-	230	290	
Turn-on delay time $V_{DD} = 30 \text{ V}$, $V_{GS} = 4.5 \text{ V}$, $I_D = 47 \text{ A}$ $R_G = 3.6 \Omega$	$t_{d(on)}$	-	15	25	ns
Rise time $V_{DD} = 30 \text{ V}$, $V_{GS} = 4.5 \text{ V}$, $I_D = 47 \text{ A}$ $R_G = 3.6 \Omega$	t_r	-	30	45	
Turn-off delay time $V_{DD} = 30 \text{ V}$, $V_{GS} = 4.5 \text{ V}$, $I_D = 47 \text{ A}$ $R_G = 3.6 \Omega$	$t_{d(off)}$	-	30	45	
Fall time $V_{DD} = 30 \text{ V}$, $V_{GS} = 4.5 \text{ V}$, $I_D = 47 \text{ A}$ $R_G = 3.6 \Omega$	t_f	-	20	30	
Gate charge at threshold $V_{DD} = 40 \text{ V}$, $I_D = 0.1 \text{ A}$, $V_{GS} = 0 \text{ to } 1 \text{ V}$	$Q_{g(th)}$	-	2	3	nC
Gate charge at 5.0 V $V_{DD} = 40 \text{ V}$, $I_D = 47 \text{ A}$, $V_{GS} = 0 \text{ to } 5 \text{ V}$	$Q_{g(5)}$	-	35	55	
Gate charge total $V_{DD} = 40 \text{ V}$, $I_D = 47 \text{ A}$, $V_{GS} = 0 \text{ to } 10 \text{ V}$	$Q_{g(total)}$	-	60	90	
Gate plateau voltage $V_{DD} = 40 \text{ V}$, $I_D = 47 \text{ A}$	$V_{(plateau)}$	-	4.1	-	V

Electrical Characteristics, at $T_j = 25^\circ\text{C}$, unless otherwise specified

Parameter	Symbol	Values			Unit
		min.	typ.	max.	
Reverse Diode					
Inverse diode continuous forward current $T_C = 25^\circ\text{C}$	I_S	-	-	47	A
Inverse diode direct current, pulsed $T_C = 25^\circ\text{C}$	I_{SM}	-	-	188	
Inverse diode forward voltage $V_{GS} = 0\text{ V}, I_F = 94\text{ A}$	V_{SD}	-	1.1	1.7	V
Reverse recovery time $V_R = 30\text{ V}, I_F = I_S, di_F/dt = 100\text{ A}/\mu\text{s}$	t_{rr}	-	75	115	ns
Reverse recovery charge $V_R = 30\text{ V}, I_F = I_S, di_F/dt = 100\text{ A}/\mu\text{s}$	Q_{rr}	-	0.15	0.25	μC

Power dissipation

$$P_{\text{tot}} = f(T_C)$$

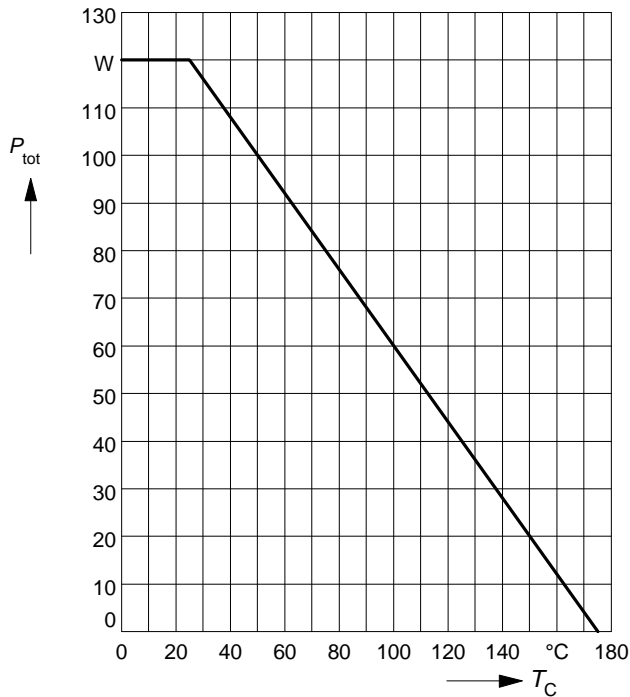

Drain current

$$I_D = f(T_C)$$

parameter: $V_{GS} \geq 4 \text{ V}$

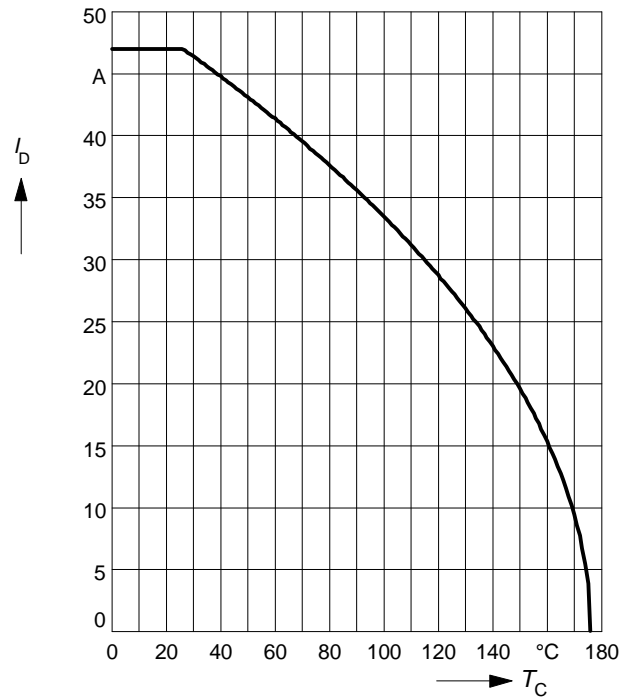

Safe operating area

$$I_D = f(V_{DS})$$

parameter: $D = 0, T_C = 25^\circ\text{C}$

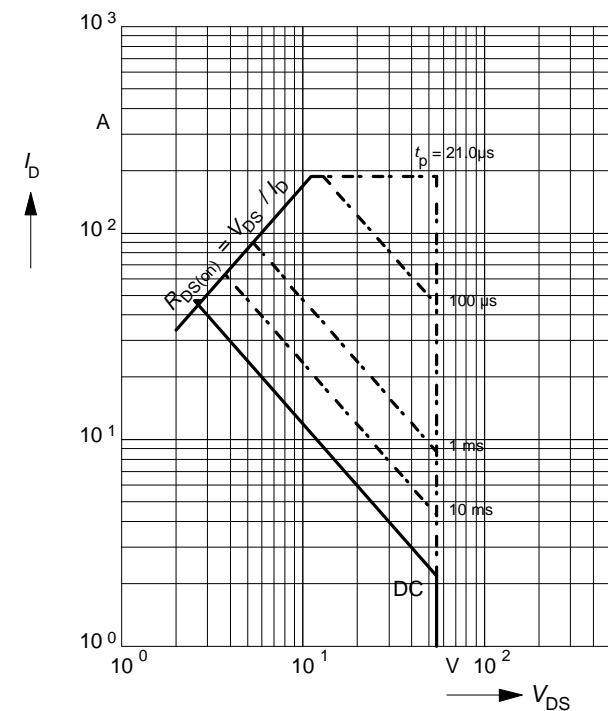

Transient thermal impedance

$$Z_{\text{th JC}} = f(t_p)$$

parameter: $D = t_p / T$

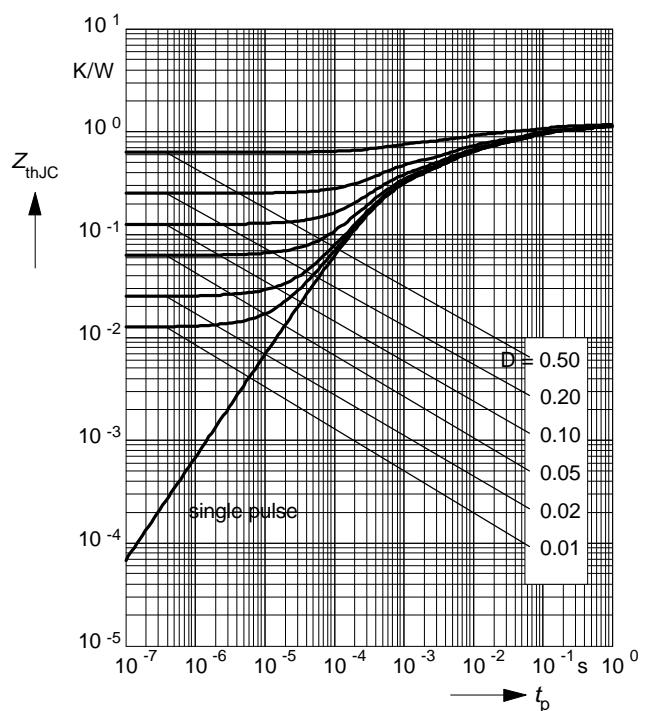

Typ. output characteristics

$$I_D = f(V_{DS})$$

parameter: $t_p = 80 \mu s$, $T_j = 25^\circ C$

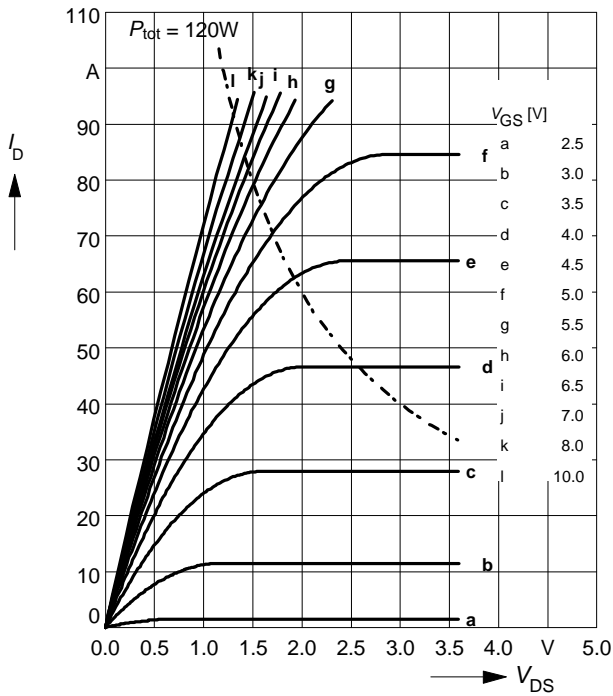

Typ. drain-source on-resistance

$$R_{DS(on)} = f(I_D)$$

parameter: $t_p = 80 \mu s$, $T_j = 25^\circ C$

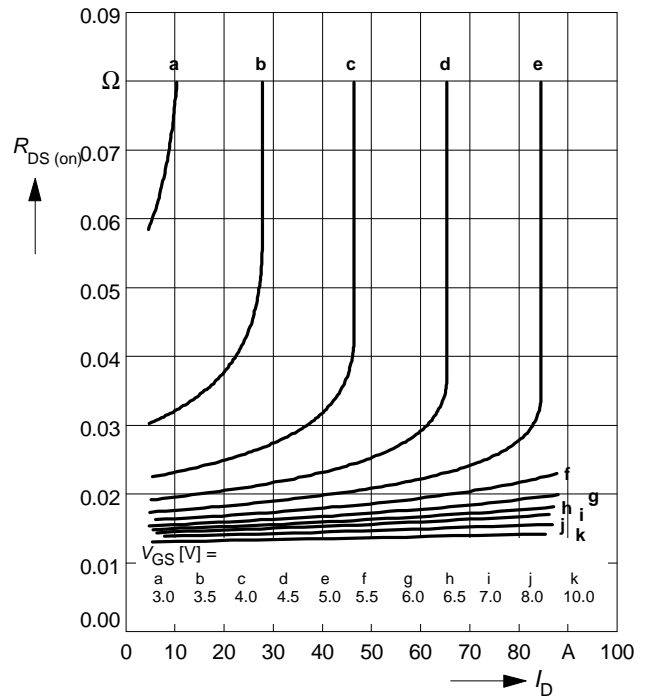

Typ. transfer characteristics $I_D = f(V_{GS})$

parameter: $t_p = 80 \mu s$

$$V_{DS} \geq 2 \times I_D \times R_{DS(on)max}$$

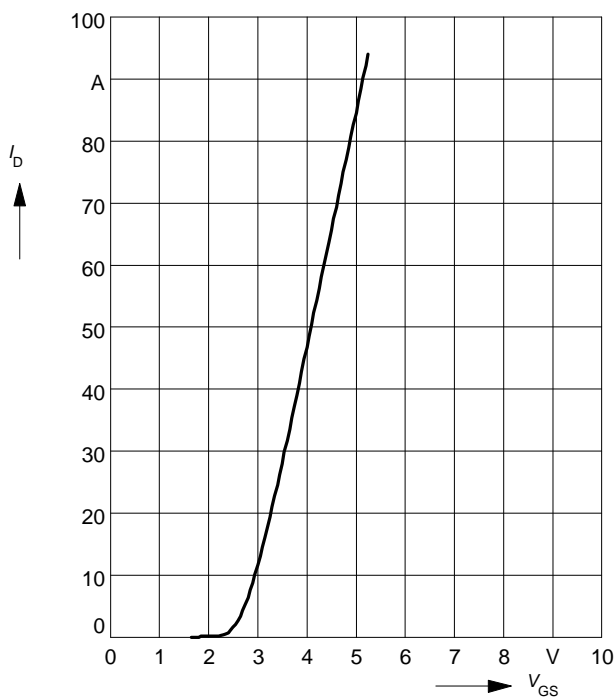

Drain-source on-resistance

$$R_{DS(on)} = f(T_j)$$

parameter: $I_D = 33 \text{ A}$, $V_{GS} = 4.5 \text{ V}$

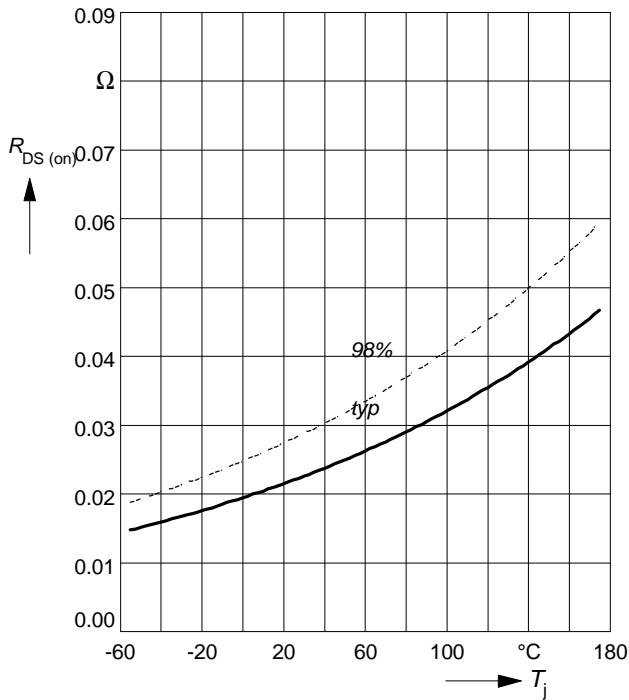

Gate threshold voltage

$$V_{GS(th)} = f(T_j)$$

parameter: $V_{GS} = V_{DS}$, $I_D = 90 \mu\text{A}$

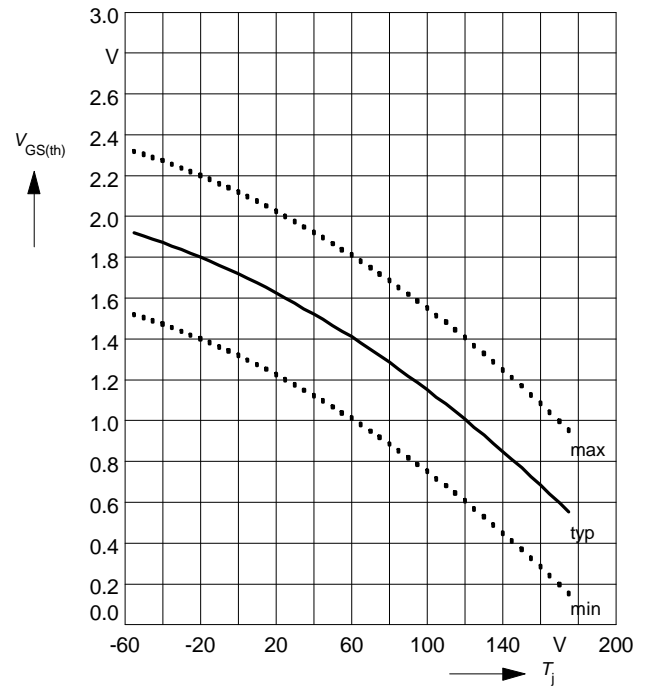

Typ. capacitances

$$C = f(V_{DS})$$

parameter: $V_{GS} = 0\text{V}$, $f = 1\text{MHz}$

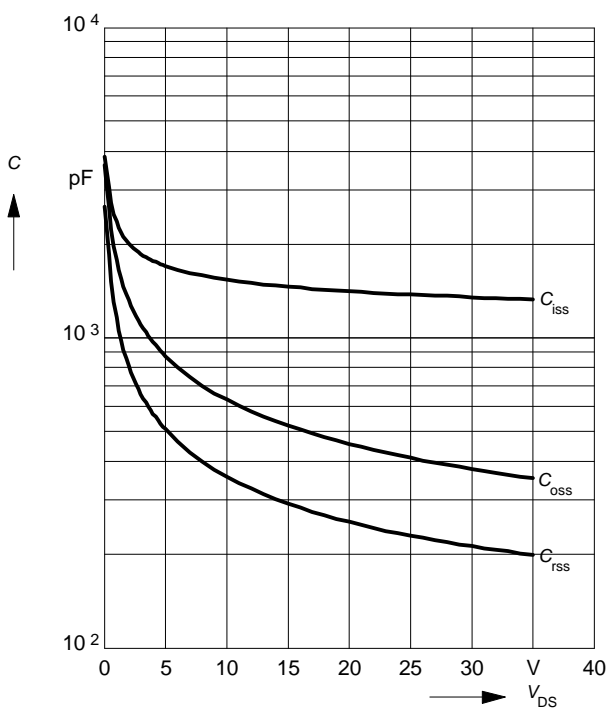

Forward characteristics of reverse diode

$$I_F = f(V_{SD})$$

parameter: T_j , $t_p = 80 \mu\text{s}$

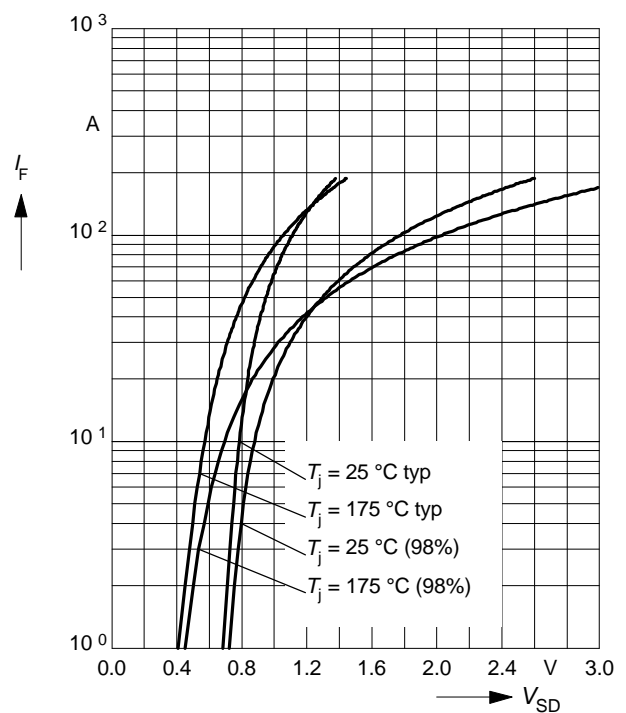

Avalanche energy $E_{AS} = f(T_j)$

parameter: $I_D = 47 \text{ A}$, $V_{DD} = 25 \text{ V}$

$R_{GS} = 25 \text{ } \Omega$, $L = 222 \text{ } \mu\text{H}$

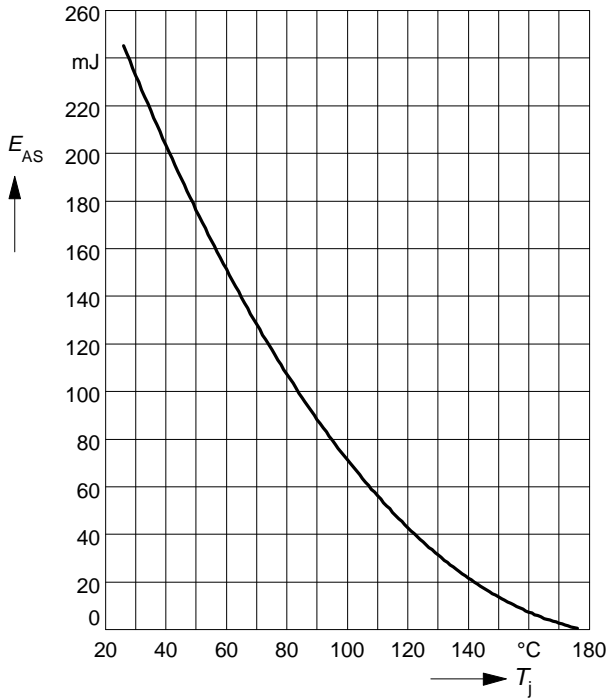

Typ. gate charge

$V_{GS} = f(Q_{Gate})$

parameter: $I_{D \text{ puls}} = 47 \text{ A}$

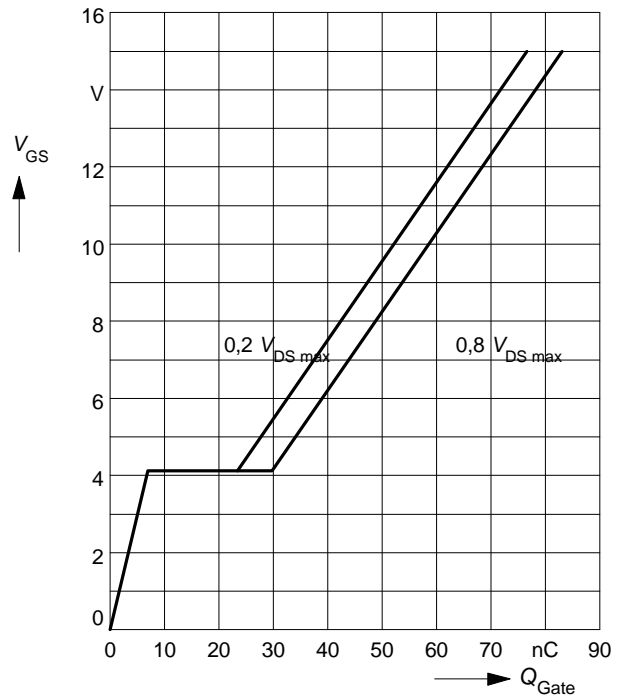

Drain-source breakdown voltage

$V_{(BR)DSS} = f(T_j)$

