

Silicon PN Photodiode

Description

BPW21R is a planar Silicon PN photodiode in a hermetically sealed short TO-5 case, especially designed for high precision linear applications.

Due to its extremely high dark resistance, the short circuit photocurrent is linear over seven decades of illumination level.

On the other hand, there is a strictly logarithmic correlation between open circuit voltage and illumination over the same range.

The device is equipped with a flat glass window with built in color correction filter, giving an approximation to the spectral response of the human eye.

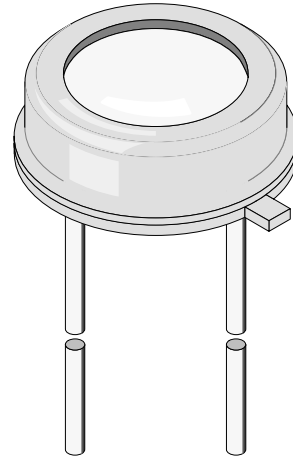

94 8394

Features

- Hermetically sealed TO-5 case
- Flat glass window with built-in color correction filter for visible radiation
- Cathode connected to case
- Wide viewing angle $\varphi = \pm 50^\circ$
- Large radiant sensitive area ($A=7.5 \text{ mm}^2$)
- Suitable for visible radiation
- High sensitivity
- Low dark current
- High shunt resistance
- Excellent linearity
- For photodiode and photovoltaic cell operation

Applications

Sensor in exposure and color measuring purposes

Absolute Maximum Ratings

$T_{amb} = 25^{\circ}\text{C}$

Parameter	Test Conditions	Symbol	Value	Unit
Reverse Voltage		V_R	10	V
Power Dissipation	$T_{amb} \leq 50^{\circ}\text{C}$	P_V	300	mW
Junction Temperature		T_j	125	$^{\circ}\text{C}$
Operating Temperature Range		T_{amb}	-55...+125	$^{\circ}\text{C}$
Storage Temperature Range		T_{stg}	-55...+125	$^{\circ}\text{C}$
Soldering Temperature	$t \leq 5\text{ s}$	T_{sd}	260	$^{\circ}\text{C}$
Thermal Resistance Junction/Ambient		R_{thJA}	250	K/W

Basic Characteristics

$T_{amb} = 25^{\circ}\text{C}$

Parameter	Test Conditions	Symbol	Min	Typ	Max	Unit
Forward Voltage	$I_F = 50\text{ mA}$	V_F		1.0	1.3	V
Breakdown Voltage	$I_R = 20\text{ }\mu\text{A}, E = 0$	$V_{(BR)}$	10			V
Reverse Dark Current	$V_R = 5\text{ V}, E = 0$	I_{ro}		2	30	nA
Diode Capacitance	$V_R = 0\text{ V}, f = 1\text{ MHz}, E = 0$	C_D		1.2		nF
	$V_R = 5\text{ V}, f = 1\text{ MHz}, E = 0$	C_D		400		pF
Dark Resistance	$V_R = 10\text{ mV}$	R_D		38		$\text{G}\Omega$
Open Circuit Voltage	$E_A = 1\text{ klx}$	V_o	280	450		mV
Temp. Coefficient of V_o	$E_A = 1\text{ klx}$	TK_{V_o}		-2		mV/K
Short Circuit Current	$E_A = 1\text{ klx}$	I_k	4.5	9		μA
Temp. Coefficient of I_k	$E_A = 1\text{ klx}$	TK_{I_k}		-0.05		%/K
Reverse Light Current	$E_A = 1\text{ klx}, V_R = 5\text{ V}$	I_{ra}	4.5	9		μA
Sensitivity	$V_R = 5\text{ V}, E_A = 10^{-2} \dots 10^5\text{ lx}$	S		9		nA/lx
Angle of Half Sensitivity		φ		± 50		deg
Wavelength of Peak Sensitivity		λ_p		565		nm
Range of Spectral Bandwidth		$\lambda_{0.5}$		420...675		nm
Rise Time	$V_R = 0\text{ V}, R_L = 1\text{ k}\Omega,$ $\lambda = 660\text{ nm}$	t_r		3.1		μs
Fall Time	$V_R = 0\text{ V}, R_L = 1\text{ k}\Omega,$ $\lambda = 660\text{ nm}$	t_f		3.0		μs

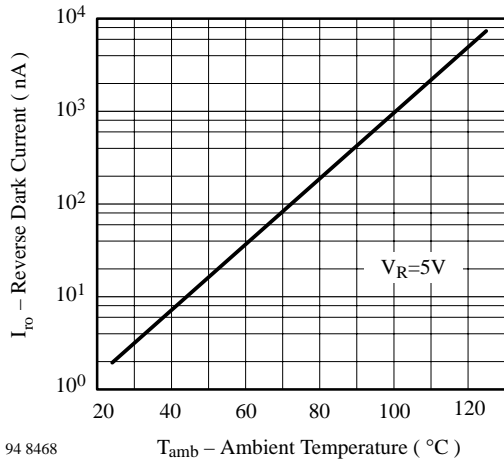
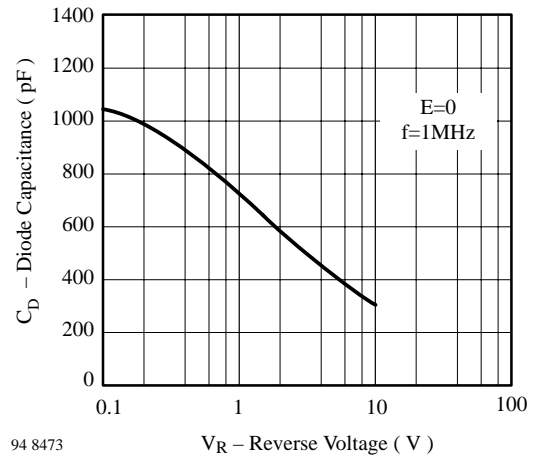
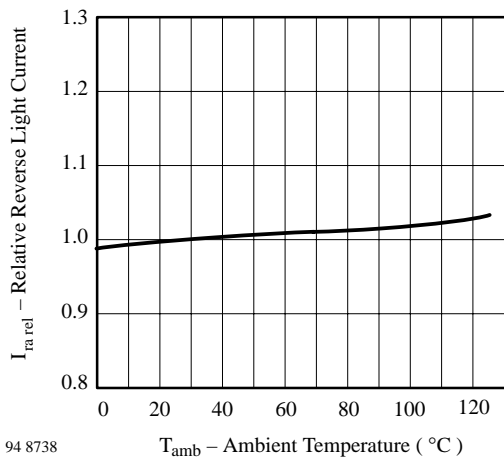
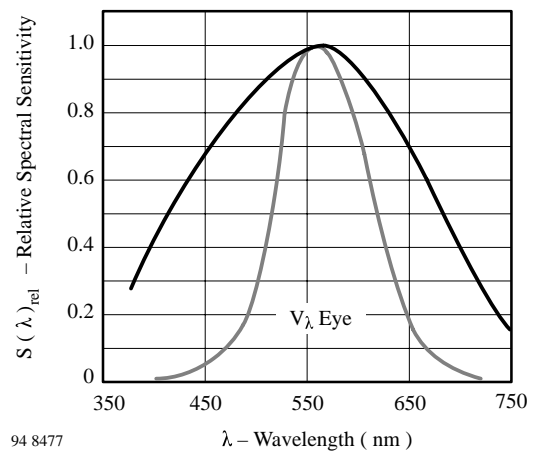
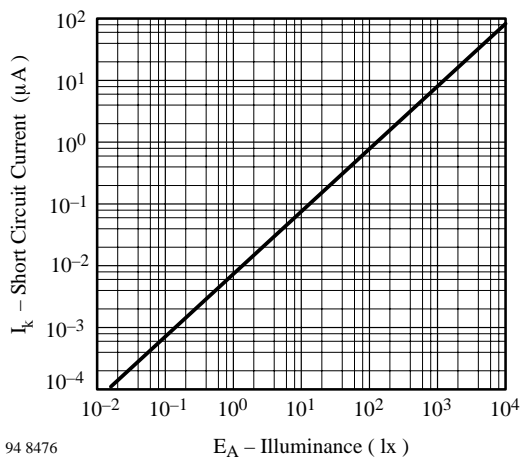
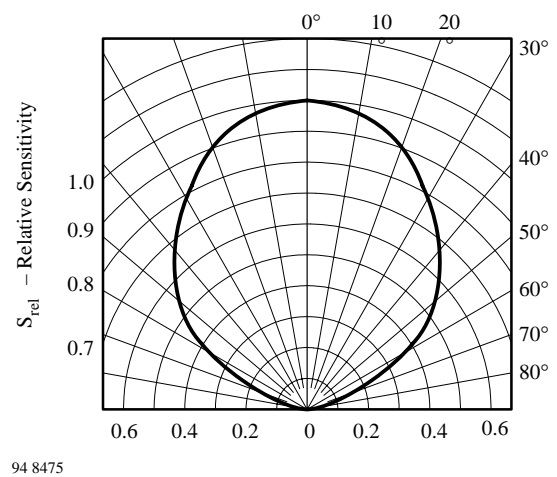
Typical Characteristics ($T_{amb} = 25^{\circ}\text{C}$ unless otherwise specified)

Figure 1. Reverse Dark Current vs. Ambient Temperature

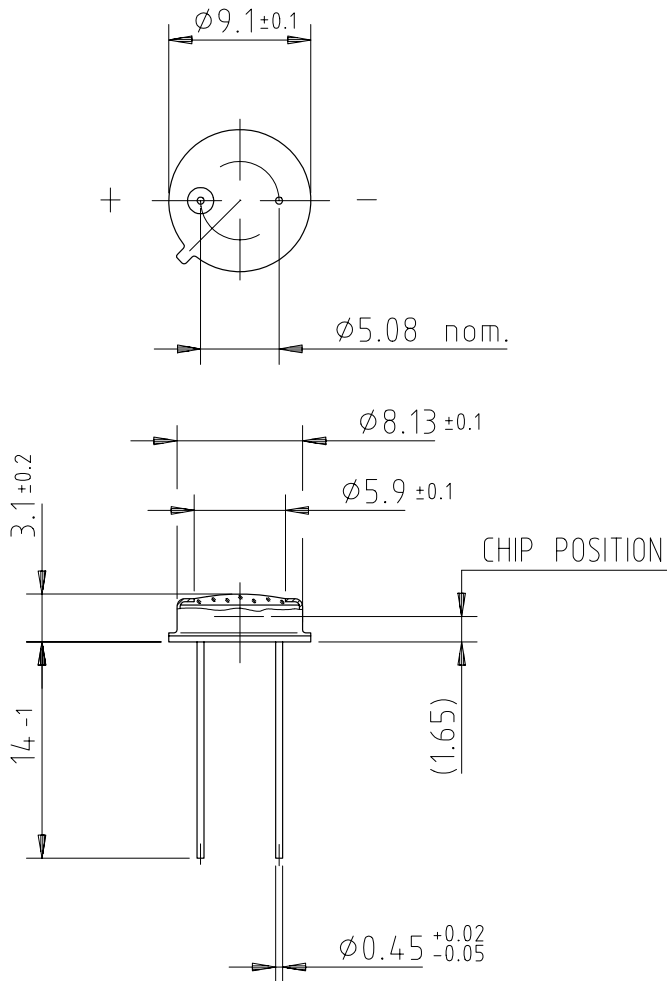
Figure 4. Diode Capacitance vs. Reverse Voltage

Figure 2. Relative Reverse Light Current vs. Ambient Temperature

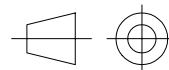
Figure 5. Relative Spectral Sensitivity vs. Wavelength

Figure 3. Short Circuit Current vs. Illuminance

Figure 6. Relative Radiant Sensitivity vs. Angular Displacement

Dimensions in mm



96 12181



technical drawings
according to DIN
specifications



Ozone Depleting Substances Policy Statement

It is the policy of **Vishay Semiconductor GmbH** to

1. Meet all present and future national and international statutory requirements.
2. Regularly and continuously improve the performance of our products, processes, distribution and operating systems with respect to their impact on the health and safety of our employees and the public, as well as their impact on the environment.

It is particular concern to control or eliminate releases of those substances into the atmosphere which are known as ozone depleting substances (ODSs).

The Montreal Protocol (1987) and its London Amendments (1990) intend to severely restrict the use of ODSs and forbid their use within the next ten years. Various national and international initiatives are pressing for an earlier ban on these substances.

Vishay Semiconductor GmbH has been able to use its policy of continuous improvements to eliminate the use of ODSs listed in the following documents.

1. Annex A, B and list of transitional substances of the Montreal Protocol and the London Amendments respectively
2. Class I and II ozone depleting substances in the Clean Air Act Amendments of 1990 by the Environmental Protection Agency (EPA) in the USA
3. Council Decision 88/540/EEC and 91/690/EEC Annex A, B and C (transitional substances) respectively.

Vishay Semiconductor GmbH can certify that our semiconductors are not manufactured with ozone depleting substances and do not contain such substances.

We reserve the right to make changes to improve technical design and may do so without further notice.

Parameters can vary in different applications. All operating parameters must be validated for each customer application by the customer. Should the buyer use Vishay-Telefunken products for any unintended or unauthorized application, the buyer shall indemnify Vishay-Telefunken against all claims, costs, damages, and expenses, arising out of, directly or indirectly, any claim of personal damage, injury or death associated with such unintended or unauthorized use.

Vishay Semiconductor GmbH, P.O.B. 3535, D-74025 Heilbronn, Germany
Telephone: 49 (0)7131 67 2831, Fax number: 49 (0)7131 67 2423