

## CD4001BC/CD4011BC

### Quad 2-Input NOR Buffered B Series Gate • Quad 2-Input NAND Buffered B Series Gate

#### General Description

The CD4001BC and CD4011BC quad gates are monolithic complementary MOS (CMOS) integrated circuits constructed with N- and P-channel enhancement mode transistors. They have equal source and sink current capabilities and conform to standard B series output drive. The devices also have buffered outputs which improve transfer characteristics by providing very high gain.

All inputs are protected against static discharge with diodes to  $V_{DD}$  and  $V_{SS}$ .

#### Features

- Low power TTL:
  - Fan out of 2 driving 74L compatibility: or 1 driving 74LS
- 5V–10V–15V parametric ratings
- Symmetrical output characteristics
- Maximum input leakage 1  $\mu$ A at 15V over full temperature range

#### Ordering Code:

Order Number	Package Number	Package Description
CD4001BCM	M14A	14-Lead Small Outline Integrated Circuit (SOIC), JEDEC MS-120, 0.150" Narrow
CD4001BCSJ	M14D	14-Lead Small Outline Package (SOP), EIAJ TYPE II, 5.3mm Wide
CD4001BCN	N14A	14-Lead Plastic Dual-In-Line Package (PDIP), JEDEC MS-001, 0.300" Wide
CD4011BCM	M14A	14-Lead Small Outline Integrated Circuit (SOIC), JEDEC MS-120, 0.150" Narrow
CD4011BCN	N14A	14-Lead Plastic Dual-In-Line Package (PDIP), JEDEC MS-001, 0.300" Wide

Devices also available in Tape and Reel. Specify by appending the suffix letter "X" to the ordering code.

#### Connection Diagrams

Pin Assignments for DIP, SOIC and SOP  
CD4001BC

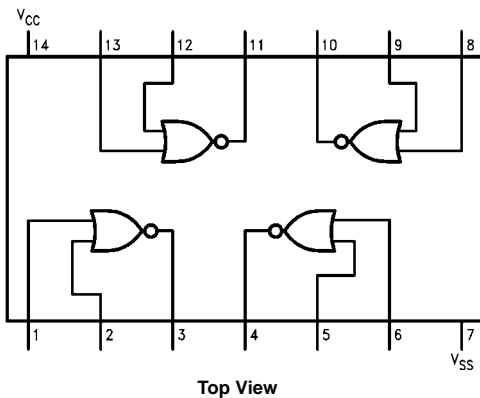

Pin Assignments for DIP and SOIC  
CD4011BC

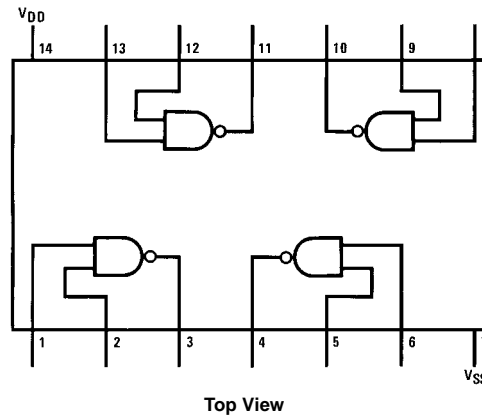

Schematic Diagrams

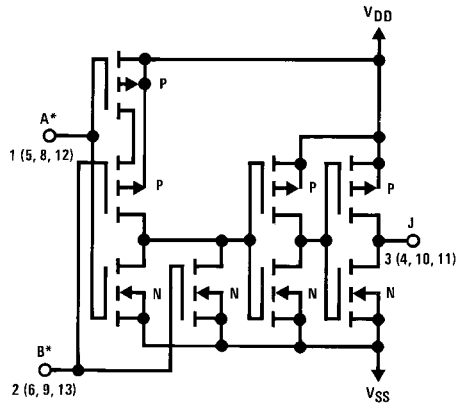

$1/4$  of device shown  
 $J = \overline{A + B}$   
 Logical "1" = HIGH  
 Logical "0" = LOW  
 All inputs protected by standard  
 CMOS protection circuit.

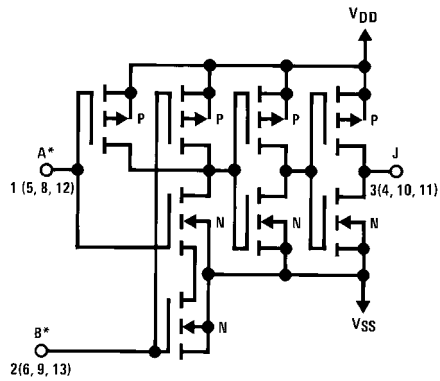
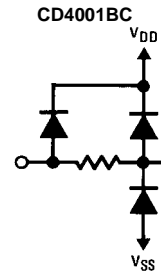

$1/4$  of device shown  
 $J = \overline{A \cdot B}$   
 Logical "1" = HIGH  
 Logical "0" = LOW  
 All inputs protected by standard  
 CMOS protection circuit.

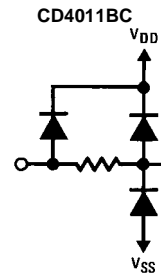

Absolute Maximum Ratings (Note 1)		Recommended Operating Conditions	
(Note 2)			
Voltage at any Pin	-0.5V to V <sub>DD</sub> +0.5V	Operating Range (V <sub>DD</sub> )	3 V <sub>DC</sub> to 15 V <sub>DC</sub>
Power Dissipation (P <sub>D</sub> )		Operating Temperature Range	
Dual-In-Line	700 mW	CD4001BC, CD4011BC	-40°C to +85°C
Small Outline	500 mW		
V <sub>DD</sub> Range	-0.5 V <sub>DC</sub> to +18 V <sub>DC</sub>		
Storage Temperature (T <sub>S</sub> )	-65°C to +150°C		
Lead Temperature (T <sub>L</sub> )			
(Soldering, 10 seconds)	260°C		

**Note 1:** "Absolute Maximum Ratings" are those values beyond which the safety of the device cannot be guaranteed. Except for "Operating Temperature Range" they are not meant to imply that the devices should be operated at these limits. The Electrical Characteristics tables provide conditions for actual device operation.

**Note 2:** All voltages measured with respect to V<sub>SS</sub> unless otherwise specified.

### DC Electrical Characteristics (Note 2)

Symbol	Parameter	Conditions	-40°C		+25°C			+85°C		Units
			Min	Max	Min	Typ	Max	Min	Max	
I <sub>DD</sub>	Quiescent Device Current	V <sub>DD</sub> = 5V, V <sub>IN</sub> = V <sub>DD</sub> or V <sub>SS</sub>		1		0.004	1		7.5	μA
		V <sub>DD</sub> = 10V, V <sub>IN</sub> = V <sub>DD</sub> or V <sub>SS</sub>		2		0.005	2		15	μA
		V <sub>DD</sub> = 15V, V <sub>IN</sub> = V <sub>DD</sub> or V <sub>SS</sub>		4		0.006	4		30	μA
V <sub>OL</sub>	LOW Level Output Voltage	V <sub>DD</sub> = 5V		0.05		0	0.05		0.05	V
		V <sub>DD</sub> = 10V	I <sub>O</sub>   < 1 μA	0.05		0	0.05		0.05	V
		V <sub>DD</sub> = 15V		0.05		0	0.05		0.05	V
V <sub>OH</sub>	HIGH Level Output Voltage	V <sub>DD</sub> = 5V	4.95		4.95	5		4.95		V
		V <sub>DD</sub> = 10V	9.95		9.95	10		9.95		V
		V <sub>DD</sub> = 15V	14.95		14.95	15		14.95		V
V <sub>IL</sub>	LOW Level Input Voltage	V <sub>DD</sub> = 5V, V <sub>O</sub> = 4.5V		1.5		2	1.5		1.5	V
		V <sub>DD</sub> = 10V, V <sub>O</sub> = 9.0V		3.0		4	3.0		3.0	V
		V <sub>DD</sub> = 15V, V <sub>O</sub> = 13.5V		4.0		6	4.0		4.0	V
V <sub>IH</sub>	HIGH Level Input Voltage	V <sub>DD</sub> = 5V, V <sub>O</sub> = 0.5V	3.5		3.5	3		3.5		V
		V <sub>DD</sub> = 10V, V <sub>O</sub> = 1.0V	7.0		7.0	6		7.0		V
		V <sub>DD</sub> = 15V, V <sub>O</sub> = 1.5V	11.0		11.0	9		11.0		V
I <sub>OL</sub>	LOW Level Output Current (Note 3)	V <sub>DD</sub> = 5V, V <sub>O</sub> = 0.4V	0.52		0.44	0.88		0.36		mA
		V <sub>DD</sub> = 10V, V <sub>O</sub> = 0.5V	1.3		1.1	2.25		0.9		mA
		V <sub>DD</sub> = 15V, V <sub>O</sub> = 1.5V	3.6		3.0	8.8		2.4		mA
I <sub>OH</sub>	HIGH Level Output Current (Note 3)	V <sub>DD</sub> = 5V, V <sub>O</sub> = 4.6V	-0.52		-0.44	-0.88		-0.36		mA
		V <sub>DD</sub> = 10V, V <sub>O</sub> = 9.5V	-1.3		-1.1	-2.25		-0.9		mA
		V <sub>DD</sub> = 15V, V <sub>O</sub> = 13.5V	-3.6		-3.0	-8.8		-2.4		mA
I <sub>IN</sub>	Input Current	V <sub>DD</sub> = 15V, V <sub>IN</sub> = 0V		-0.30		-10 <sup>-5</sup>	-0.30		-1.0	μA
		V <sub>DD</sub> = 15V, V <sub>IN</sub> = 15V		0.30		10 <sup>-5</sup>	0.30		1.0	μA

**Note 3:** I<sub>OL</sub> and I<sub>OH</sub> are tested one output at a time.

### AC Electrical Characteristics (Note 4)

CD4001BC: T<sub>A</sub> = 25°C, Input t<sub>r</sub>; t<sub>f</sub> = 20 ns. C<sub>L</sub> = 50 pF, R<sub>L</sub> = 200k. Typical temperature coefficient is 0.3%/°C.

Symbol	Parameter	Conditions	Typ	Max	Units
t <sub>PHL</sub>	Propagation Delay Time, HIGH-to-LOW Level	V <sub>DD</sub> = 5V	120	250	ns
		V <sub>DD</sub> = 10V	50	100	ns
		V <sub>DD</sub> = 15V	35	70	ns
t <sub>PLH</sub>	Propagation Delay Time, LOW-to-HIGH Level	V <sub>DD</sub> = 5V	110	250	ns
		V <sub>DD</sub> = 10V	50	100	ns
		V <sub>DD</sub> = 15V	35	70	ns
t <sub>THL}, t<sub>TLH</sub></sub>	Transition Time	V <sub>DD</sub> = 5V	90	200	ns
		V <sub>DD</sub> = 10V	50	100	ns
		V <sub>DD</sub> = 15V	40	80	ns
C <sub>IN</sub>	Average Input Capacitance	Any Input	5	7.5	pF
C <sub>PD</sub>	Power Dissipation Capacity	Any Gate	14		pF

**Note 4:** AC Parameters are guaranteed by DC correlated testing.

### AC Electrical Characteristics (Note 5)

CD4011BC:  $T_A = 25^\circ\text{C}$ , Input  $t_r, t_f = 20$  ns.  $C_L = 50$  pF,  $R_L = 200\text{k}$ . Typical Temperature Coefficient is  $0.3\%/^\circ\text{C}$ .

Symbol	Parameter	Conditions	Typ	Max	Units
$t_{PHL}$	Propagation Delay, HIGH-to-LOW Level	$V_{DD} = 5\text{V}$	120	250	ns
		$V_{DD} = 10\text{V}$	50	100	ns
		$V_{DD} = 15\text{V}$	35	70	ns
$t_{PLH}$	Propagation Delay, LOW-to-HIGH Level	$V_{DD} = 5\text{V}$	85	250	ns
		$V_{DD} = 10\text{V}$	40	100	ns
		$V_{DD} = 15\text{V}$	30	70	ns
$t_{THL}, t_{TLH}$	Transition Time	$V_{DD} = 5\text{V}$	90	200	ns
		$V_{DD} = 10\text{V}$	50	100	ns
		$V_{DD} = 15\text{V}$	40	80	ns
$C_{IN}$	Average Input Capacitance	Any Input	5	7.5	pF
$C_{PD}$	Power Dissipation Capacity	Any Gate	14		pF

Note 5: AC Parameters are guaranteed by DC correlated testing.

### Typical Performance Characteristics

Typical Transfer Characteristics

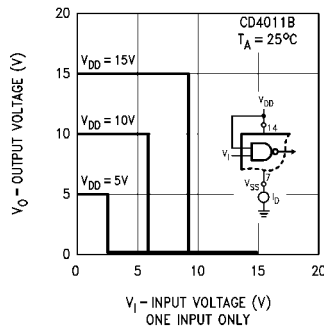

Typical Transfer Characteristics

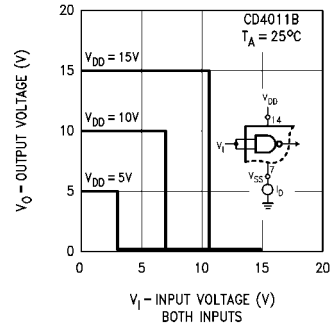

Typical Transfer Characteristics

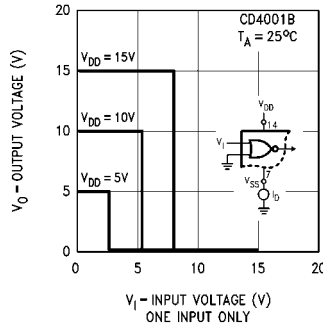

### Typical Transfer Characteristics

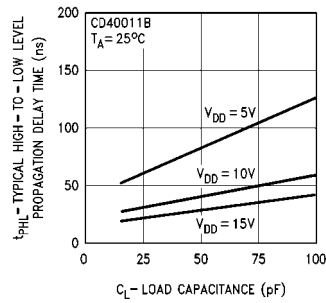
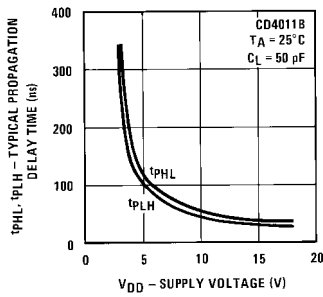
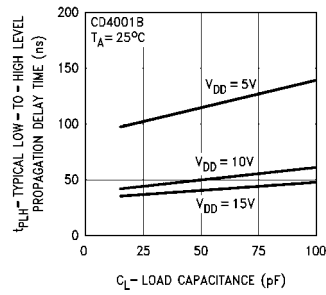
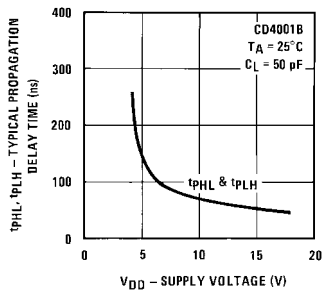
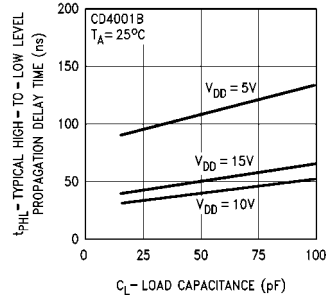
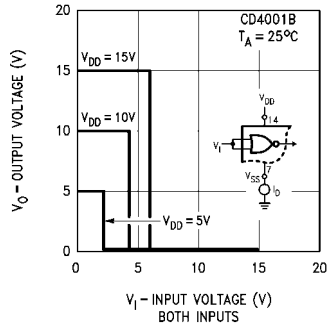

**CD4001BC/CD4011BC**

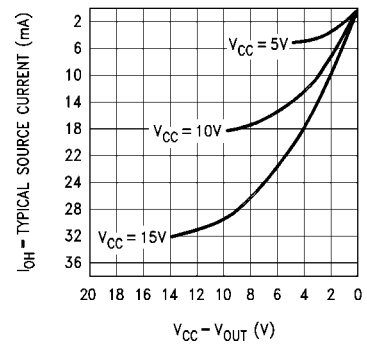
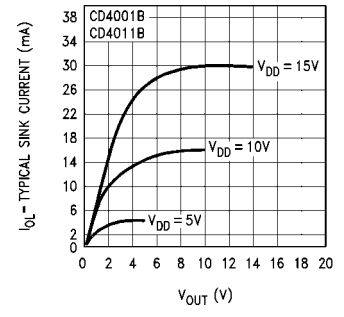
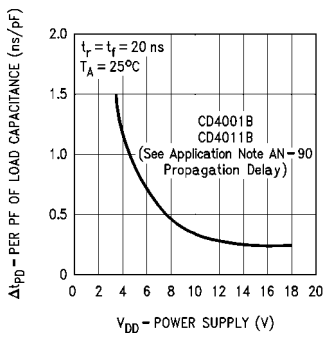
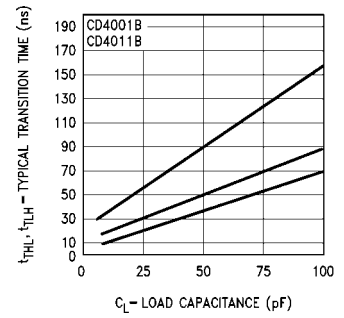
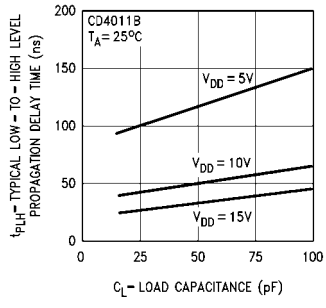

**Physical Dimensions** inches (millimeters) unless otherwise noted

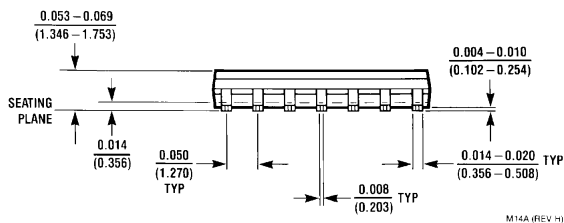
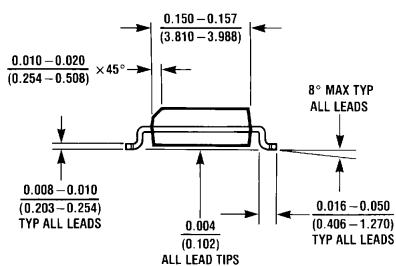
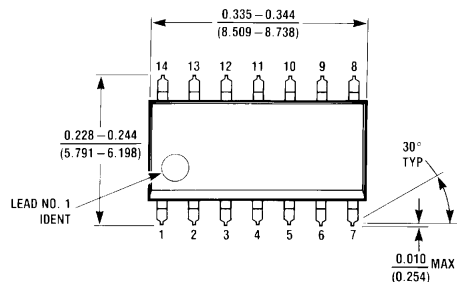

M14A (REV H)

**14-Lead Small Outline Integrated Circuit (SOIC), JEDEC MS-120, 0.150" Narrow  
Package Number M14A**

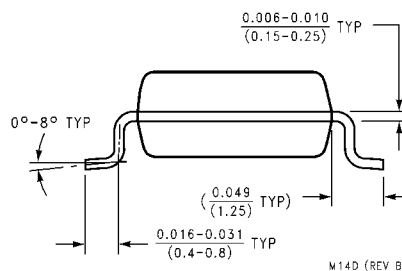
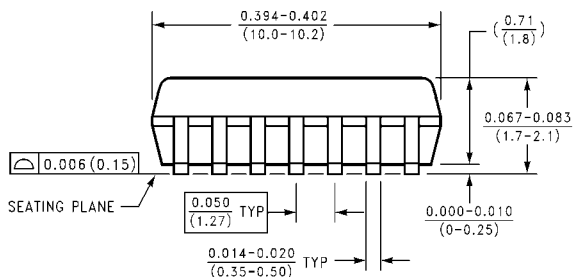
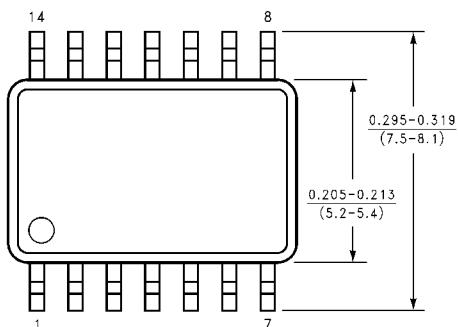

M14D (REV B)

**14-Lead Small Outline Package (SOP), EIAJ TYPE II, 5.3mm Wide  
Package Number M14D**

**Physical Dimensions** inches (millimeters) unless otherwise noted (Continued)

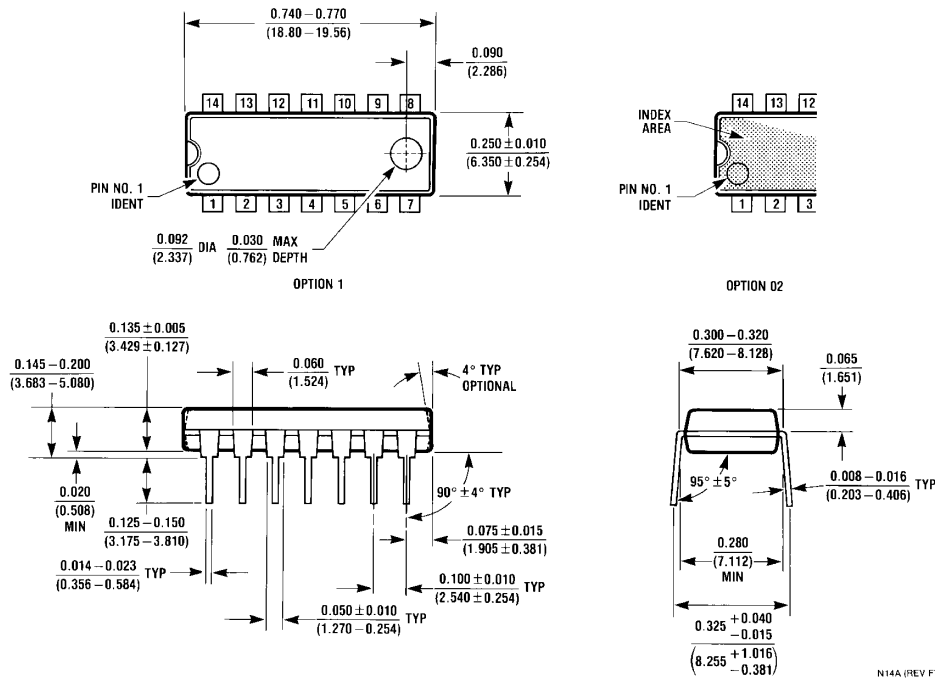

N14A (REV F)

**14-Lead Plastic Dual-In-Line Package (PDIP), JEDEC MS-001, 0.300" Wide Package Number N14A**

**LIFE SUPPORT POLICY**

FAIRCHILD'S PRODUCTS ARE NOT AUTHORIZED FOR USE AS CRITICAL COMPONENTS IN LIFE SUPPORT DEVICES OR SYSTEMS WITHOUT THE EXPRESS WRITTEN APPROVAL OF THE PRESIDENT OF FAIRCHILD SEMICONDUCTOR CORPORATION. As used herein:

1. Life support devices or systems are devices or systems which, (a) are intended for surgical implant into the body, or (b) support or sustain life, and (c) whose failure to perform when properly used in accordance with instructions for use provided in the labeling, can be reasonably expected to result in a significant injury to the user.
2. A critical component in any component of a life support device or system whose failure to perform can be reasonably expected to cause the failure of the life support device or system, or to affect its safety or effectiveness.

[www.fairchildsemi.com](http://www.fairchildsemi.com)



# Mouser Electronics

Authorized Distributor

Click to View Pricing, Inventory, Delivery & Lifecycle Information:

[Fairchild Semiconductor:](#)

[CD4011BCM](#) [CD4011BCN](#) [CD4011BCN\\_Q](#) [CD4011BCM\\_Q](#)