

# 1SMB59xxBT3G Series, SZ1SMB59xxT3G Series

## 3 Watt Plastic Surface Mount Zener Voltage Regulators

This complete new line of 3 W Zener diodes offers the following advantages.

### Features

- Zener Voltage Range – 3.3 V to 200 V
- ESD Rating of Class 3 (> 16 kV) per Human Body Model
- Flat Handling Surface for Accurate Placement
- Package Design for Top Side or Bottom Circuit Board Mounting
- AEC-Q101 Qualified and PPAP Capable – SZ1SMB59xxT3G
- SZ Prefix for Automotive and Other Applications Requiring Unique Site and Control Change Requirements
- Pb-Free Packages are Available\*

### Mechanical Characteristics:

**CASE:** Void-free, transfer-molded plastic

**FINISH:** All external surfaces are corrosion resistant and leads are readily solderable

**MAXIMUM LEAD TEMPERATURE FOR SOLDERING PURPOSES:**  
260°C for 10 Seconds

**LEADS:** Modified L-Bend providing more contact area to bond pads

**POLARITY:** Cathode indicated by polarity band

**FLAMMABILITY RATING:** UL 94 V-0

### MAXIMUM RATINGS

Rating	Symbol	Value	Unit
Maximum Steady State Power Dissipation @ $T_L = 75^\circ\text{C}$ Measured at Zero Lead Length Derate Above $75^\circ\text{C}$	$P_D$	3.0	W
Thermal Resistance from Junction-to-Lead	$R_{\theta JL}$	40 25	$\text{mW}/^\circ\text{C}$ $^\circ\text{C}/\text{W}$
Maximum Steady State Power Dissipation @ $T_A = 25^\circ\text{C}$ (Note) Derate Above $25^\circ\text{C}$	$P_D$	550 4.4	mW $\text{mW}/^\circ\text{C}$
Thermal Resistance from Junction-to-Ambient	$R_{\theta JA}$	226	$^\circ\text{C}/\text{W}$
Operating and Storage Temperature Range	$T_J, T_{stg}$	-65 to +150	$^\circ\text{C}$

Stresses exceeding Maximum Ratings may damage the device. Maximum Ratings are stress ratings only. Functional operation above the Recommended Operating Conditions is not implied. Extended exposure to stresses above the Recommended Operating Conditions may affect device reliability.

1. FR-4 board, using recommended footprint.

\*For additional information on our Pb-Free strategy and soldering details, please download the ON Semiconductor Soldering and Mounting Techniques Reference Manual, SOLDERRM/D.



ON Semiconductor®

<http://onsemi.com>

**PLASTIC SURFACE MOUNT  
ZENER VOLTAGE  
REGULATOR DIODES  
3.3–200 V, 3 W DC POWER**



**SMB  
CASE 403A  
PLASTIC**

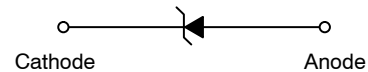

### MARKING DIAGRAM



A = Assembly Location  
Y = Year  
WW = Work Week  
9xxB = Device Code (Refer to page 3)  
▪ = Pb-Free Package

(Note: Microdot may be in either location)

### ORDERING INFORMATION

Device	Package	Shipping†
1SMB59xxBT3G	SMB (Pb-Free)	2,500 / Tape & Reel
SZ1SMB59xxBT3G	SMB (Pb-Free)	2,500 / Tape & Reel

†For information on tape and reel specifications, including part orientation and tape sizes, please refer to our Tape and Reel Packaging Specifications Brochure, BRD8011/D.

### DEVICE MARKING INFORMATION

See specific marking information in the device marking column of the Electrical Characteristics table on page 3 of this data sheet.

# 1SMB59xxBT3G Series, SZ1SMB59xxT3G Series

## ELECTRICAL CHARACTERISTICS

( $T_L = 30^\circ\text{C}$  unless otherwise noted,  
 $V_F = 1.5\text{ V Max. @ } I_F = 200\text{ mA(dc)}$  for all types)

Symbol	Parameter
$V_Z$	Reverse Zener Voltage @ $I_{ZT}$
$I_{ZT}$	Reverse Current
$Z_{ZT}$	Maximum Zener Impedance @ $I_{ZT}$
$I_{ZK}$	Reverse Current
$Z_{ZK}$	Maximum Zener Impedance @ $I_{ZK}$
$I_R$	Reverse Leakage Current @ $V_R$
$V_R$	Reverse Voltage
$I_F$	Forward Current
$V_F$	Forward Voltage @ $I_F$
$I_{ZM}$	Maximum DC Zener Current

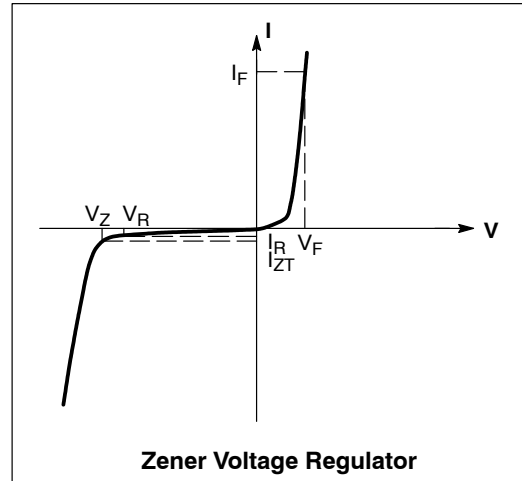

# 1SMB59xxBT3G Series, SZ1SMB59xxT3G Series

**ELECTRICAL CHARACTERISTICS** ( $T_L = 30^\circ\text{C}$  unless otherwise noted,  $V_F = 1.5\text{ V Max.}$  @  $I_F = 200\text{ mA(dc)}$  for all types)  
(Devices listed in **bold, italic** are ON Semiconductor Preferred devices.)

Device* (Note 2)	Device Marking	Zener Voltage (Note 3)				Zener Impedance (Note 4)			Leakage Current		$I_{ZM}$ mA(dc)
		$V_Z$ (Volts)			@ $I_{ZT}$	$Z_{ZT}$ @ $I_{ZT}$	$Z_{ZK}$ @ $I_{ZK}$		$I_R$ @ $V_R$		
		Min	Nom	Max	mA	$\Omega$	$\Omega$	mA	$\mu\text{A}$	Volts	
1SMB5913BT3G	913B	3.13	3.3	3.47	113.6	10	500	1	100	1	454
1SMB5914BT3G	914B	3.42	3.6	3.78	104.2	9	500	1	75	1	416
<b>1SMB5915BT3G</b>	<b>915B</b>	<b>3.70</b>	<b>3.9</b>	<b>4.10</b>	<b>96.1</b>	<b>7.5</b>	<b>500</b>	<b>1</b>	<b>25</b>	<b>1</b>	<b>384</b>
<b>1SMB5916BT3G</b>	<b>916B</b>	<b>4.08</b>	<b>4.3</b>	<b>4.52</b>	<b>87.2</b>	<b>6</b>	<b>500</b>	<b>1</b>	<b>5</b>	<b>1</b>	<b>348</b>
<b>1SMB5917BT3G</b>	<b>917B</b>	<b>4.46</b>	<b>4.7</b>	<b>4.94</b>	<b>79.8</b>	<b>5</b>	<b>500</b>	<b>1</b>	<b>5</b>	<b>1.5</b>	<b>319</b>
<b>1SMB5918BT3G</b>	<b>918B</b>	<b>4.84</b>	<b>5.1</b>	<b>5.36</b>	<b>73.5</b>	<b>4</b>	<b>350</b>	<b>1</b>	<b>5</b>	<b>2</b>	<b>294</b>
<b>1SMB5919BT3G</b>	<b>919B</b>	<b>5.32</b>	<b>5.6</b>	<b>5.88</b>	<b>66.9</b>	<b>2</b>	<b>250</b>	<b>1</b>	<b>5</b>	<b>3</b>	<b>267</b>
<b>1SMB5920BT3G</b>	<b>920B</b>	<b>5.89</b>	<b>6.2</b>	<b>6.51</b>	<b>60.5</b>	<b>2</b>	<b>200</b>	<b>1</b>	<b>5</b>	<b>4</b>	<b>241</b>
1SMB5921BT3G	921B	6.46	6.8	7.14	55.1	2.5	200	1	5	5.2	220
1SMB5922BT3G	922B	7.12	7.5	7.88	50	3	400	0.5	5	6	200
<b>1SMB5923BT3G</b>	<b>923B</b>	<b>7.79</b>	<b>8.2</b>	<b>8.61</b>	<b>45.7</b>	<b>3.5</b>	<b>400</b>	<b>0.5</b>	<b>5</b>	<b>6.5</b>	<b>182</b>
1SMB5924BT3G	924B	8.64	9.1	9.56	41.2	4	500	0.5	5	7	164
<b>1SMB5925BT3G</b>	<b>925B</b>	<b>9.5</b>	<b>10</b>	<b>10.5</b>	<b>37.5</b>	<b>4.5</b>	<b>500</b>	<b>0.25</b>	<b>5</b>	<b>8</b>	<b>150</b>
<b>1SMB5926BT3G</b>	<b>926B</b>	<b>10.45</b>	<b>11</b>	<b>11.55</b>	<b>34.1</b>	<b>5.5</b>	<b>550</b>	<b>0.25</b>	<b>1</b>	<b>8.4</b>	<b>136</b>
<b>1SMB5927BT3G</b>	<b>927B</b>	<b>11.4</b>	<b>12</b>	<b>12.6</b>	<b>31.2</b>	<b>6.5</b>	<b>550</b>	<b>0.25</b>	<b>1</b>	<b>9.1</b>	<b>125</b>
1SMB5928BT3G	928B	12.35	13	13.65	28.8	7	550	0.25	1	9.9	115
<b>1SMB5929BT3G</b>	<b>929B</b>	<b>14.25</b>	<b>15</b>	<b>15.75</b>	<b>25</b>	<b>9</b>	<b>600</b>	<b>0.25</b>	<b>1</b>	<b>11.4</b>	<b>100</b>
1SMB5930BT3G	930B	15.2	16	16.8	23.4	10	600	0.25	1	12.2	93
<b>1SMB5931BT3G</b>	<b>931B</b>	<b>17.1</b>	<b>18</b>	<b>18.9</b>	<b>20.8</b>	<b>12</b>	<b>650</b>	<b>0.25</b>	<b>1</b>	<b>13.7</b>	<b>83</b>
1SMB5932BT3G	932B	19	20	21	18.7	14	650	0.25	1	15.2	75
1SMB5933BT3G	933B	20.9	22	23.1	17	17.5	650	0.25	1	16.7	68
<b>1SMB5934BT3G</b>	<b>934B</b>	<b>22.8</b>	<b>24</b>	<b>25.2</b>	<b>15.6</b>	<b>19</b>	<b>700</b>	<b>0.25</b>	<b>1</b>	<b>18.2</b>	<b>62</b>
<b>1SMB5935BT3G</b>	<b>935B</b>	<b>25.65</b>	<b>27</b>	<b>28.35</b>	<b>13.9</b>	<b>23</b>	<b>700</b>	<b>0.25</b>	<b>1</b>	<b>20.6</b>	<b>55</b>
<b>1SMB5936BT3G</b>	<b>936B</b>	<b>28.5</b>	<b>30</b>	<b>31.5</b>	<b>12.5</b>	<b>28</b>	<b>750</b>	<b>0.25</b>	<b>1</b>	<b>22.8</b>	<b>50</b>
1SMB5937BT3G	937B	31.35	33	34.65	11.4	33	800	0.25	1	25.1	45
<b>1SMB5938BT3G</b>	<b>938B</b>	<b>34.2</b>	<b>36</b>	<b>37.8</b>	<b>10.4</b>	<b>38</b>	<b>850</b>	<b>0.25</b>	<b>1</b>	<b>27.4</b>	<b>41</b>
1SMB5939BT3G	939B	37.05	39	40.95	9.6	45	900	0.25	1	29.7	38
1SMB5940BT3G	940B	40.85	43	45.15	8.7	53	950	0.25	1	32.7	34
1SMB5941BT3G	941B	44.65	47	49.35	8	67	1000	0.25	1	35.8	31
1SMB5942BT3G	942B	48.45	51	53.55	7.3	70	1100	0.25	1	38.8	29
1SMB5943BT3G	943B	53.2	56	58.8	6.7	86	1300	0.25	1	42.6	26
1SMB5944BT3G	944B	58.9	62	65.1	6	100	1500	0.25	1	47.1	24
1SMB5945BT3G	945B	64.6	68	71.4	5.5	120	1700	0.25	1	51.7	22
1SMB5946BT3G	946B	71.25	75	78.75	5	140	2000	0.25	1	56	20
1SMB5947BT3G	947B	77.9	82	86.1	4.6	160	2500	0.25	1	62.2	18
1SMB5948BT3G	948B	86.45	91	95.55	4.1	200	3000	0.25	1	69.2	16
<b>1SMB5949BT3G</b>	<b>949B</b>	<b>95</b>	<b>100</b>	<b>105</b>	<b>3.7</b>	<b>250</b>	<b>3100</b>	<b>0.25</b>	<b>1</b>	<b>76</b>	<b>15</b>
1SMB5950BT3G	950B	104.5	110	115.5	3.4	300	4000	0.25	1	83.6	13
1SMB5951BT3G	951B	114	120	126	3.1	380	4500	0.25	1	91.2	12
1SMB5952BT3G	952B	123.5	130	136.5	2.9	450	5000	0.25	1	98.8	11
1SMB5953BT3G	953B	142.5	150	157.5	2.5	600	6000	0.25	1	114	10
1SMB5954BT3G	954B	152	160	168	2.3	700	6500	0.25	1	121.6	9
1SMB5955BT3G	955B	171	180	189	2.1	900	7000	0.25	1	136.8	8
1SMB5956BT3G	956B	190	200	210	1.9	1200	8000	0.25	1	152	7

2. **TOLERANCE AND TYPE NUMBER DESIGNATION** The type numbers listed indicate a tolerance of  $\pm 5\%$ .

3. **ZENER VOLTAGE ( $V_Z$ ) MEASUREMENT**

Nominal Zener voltage is measured with the device junction in thermal equilibrium with ambient temperature at  $25^\circ\text{C}$ .

4. **ZENER IMPEDANCE ( $Z_Z$ ) DERIVATION**  $Z_{ZT}$  and  $Z_{ZK}$  are measured by dividing the ac voltage drop across the device by the ac current applied. The specified limits are for  $I_{Z(ac)} = 0.1 I_{Z(dc)}$  with the ac frequency = 60 Hz.

\*Include SZ-prefix devices where applicable.

# 1SMB59xxBT3G Series, SZ1SMB59xxT3G Series

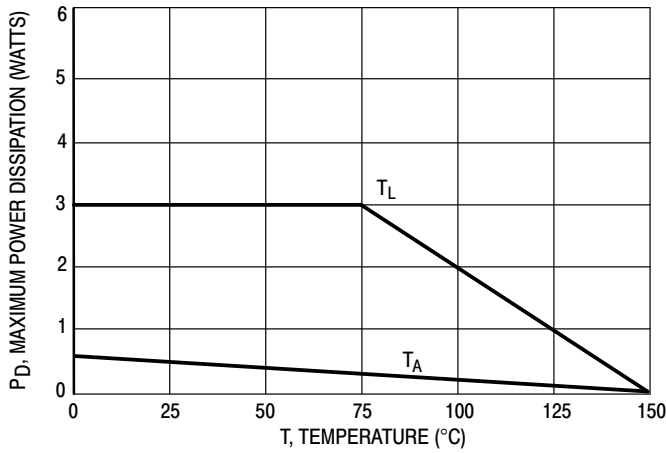

Figure 1. Steady State Power Derating

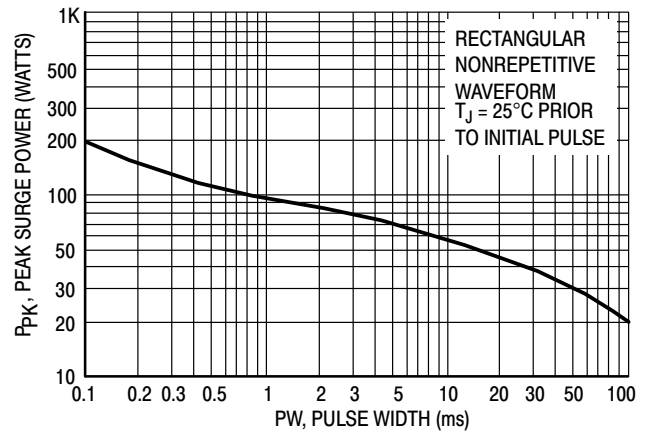

Figure 2. Maximum Surge Power

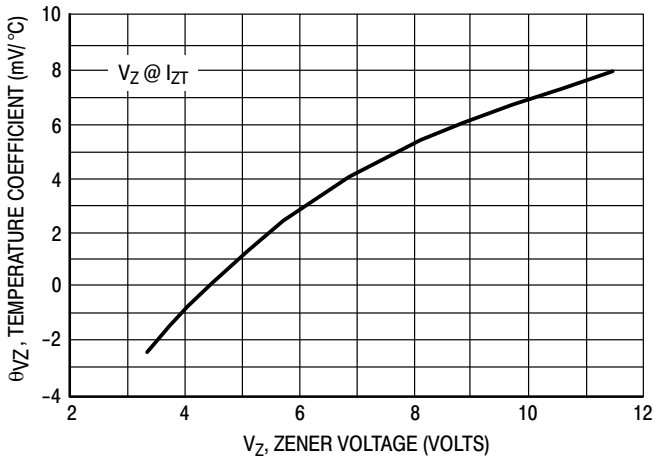

Figure 3. Zener Voltage - To 12 Volts

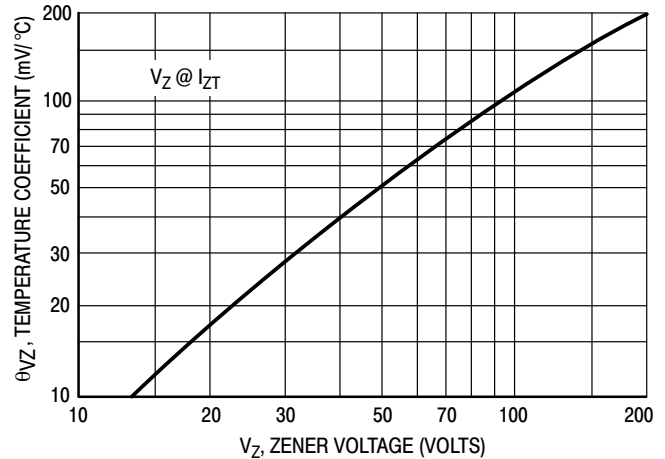

Figure 4. Zener Voltage - 14 To 200 Volts

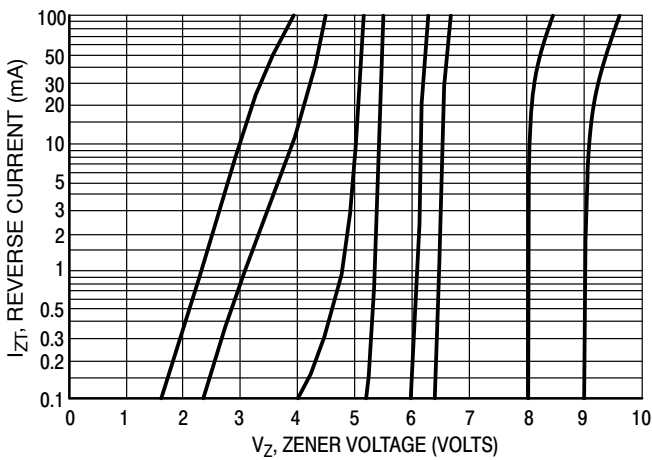

Figure 5.  $V_Z = 3.3$  thru 10 Volts

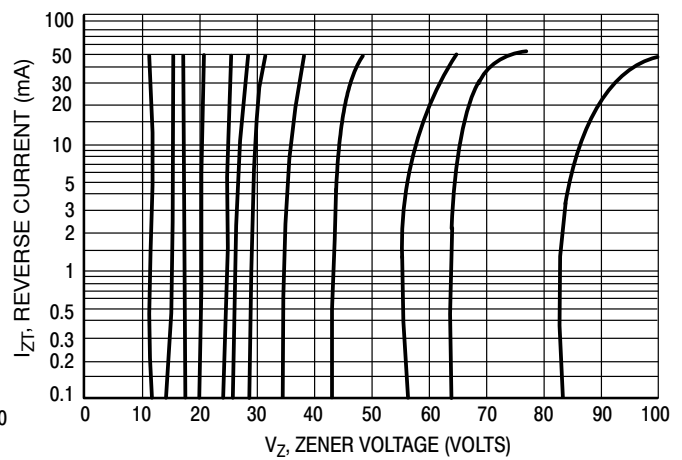

Figure 6.  $V_Z = 12$  thru 82 Volts

# 1SMB59xxBT3G Series, SZ1SMB59xxT3G Series

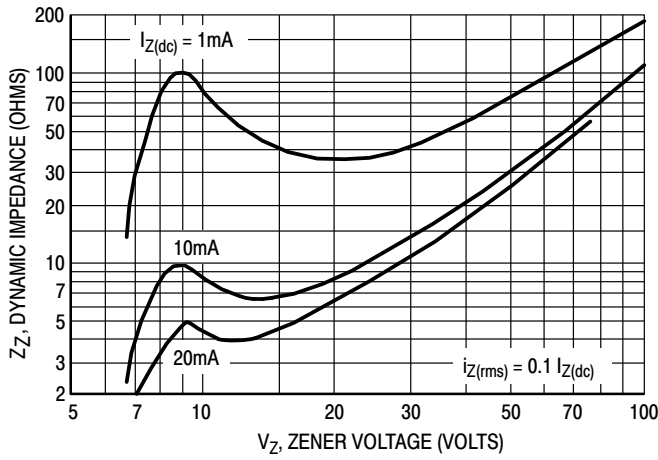

Figure 7. Effect of Zener Voltage

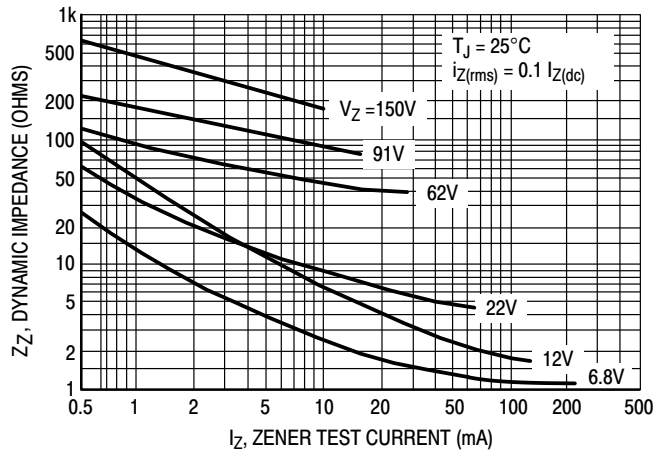

Figure 8. Effect of Zener Current

## Rating and Typical Characteristic Curves ( $T_A = 25^\circ\text{C}$ )

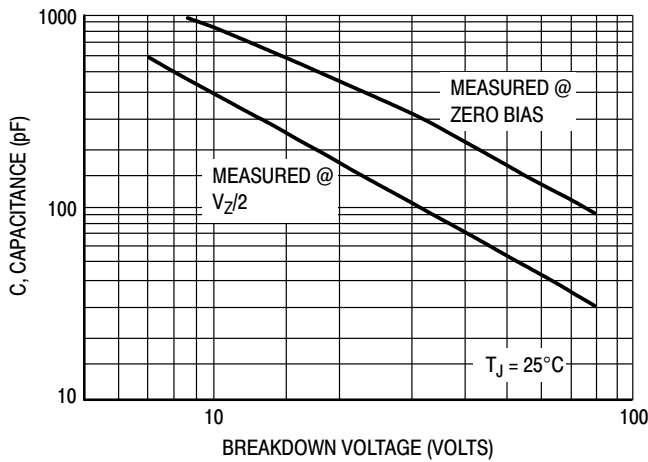

Figure 9. Capacitance Curve

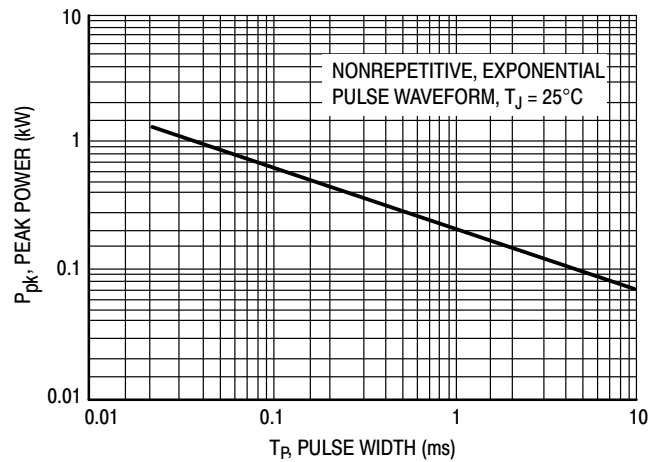

Figure 10. Typical Pulse Rating Curve

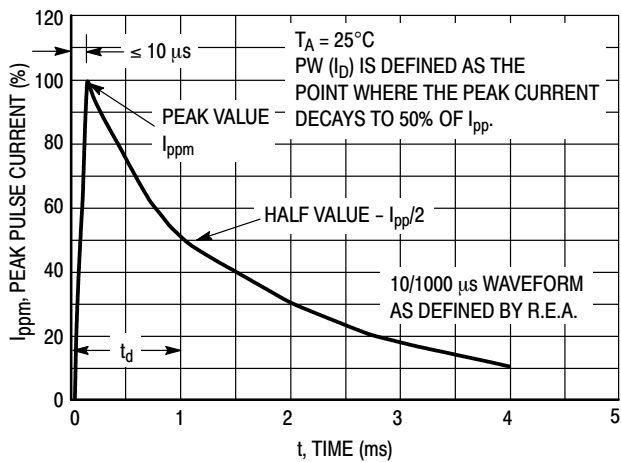

Figure 11. Pulse Waveform

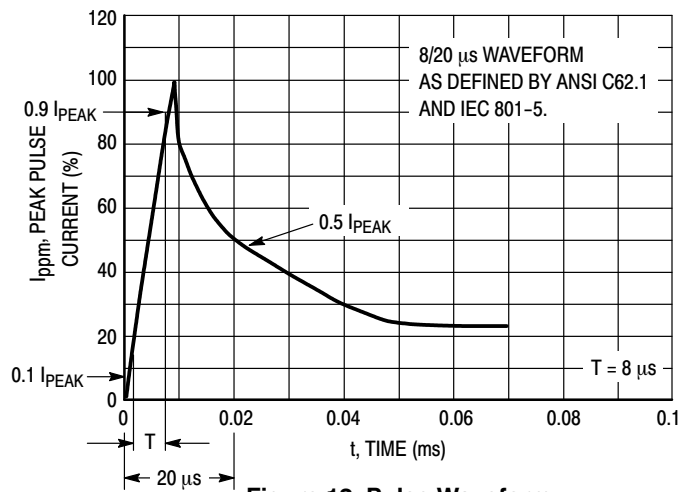
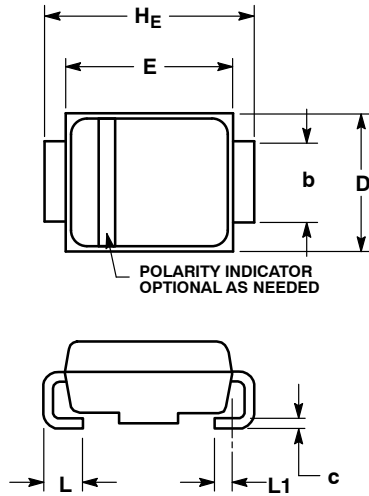

Figure 12. Pulse Waveform

# 1SMB59xxBT3G Series, SZ1SMB59xxT3G Series

## PACKAGE DIMENSIONS

### SMB CASE 403A-03 ISSUE H



- NOTES:
1. DIMENSIONING AND TOLERANCING PER ANSI Y14.5M, 1982.
  2. CONTROLLING DIMENSION: INCH.
  3. D DIMENSION SHALL BE MEASURED WITHIN DIMENSION P.

DIM	MILLIMETERS			INCHES		
	MIN	NOM	MAX	MIN	NOM	MAX
A	1.90	2.20	2.28	0.075	0.087	0.090
A1	0.05	0.10	0.19	0.002	0.004	0.007
b	1.96	2.03	2.20	0.077	0.080	0.087
c	0.15	0.23	0.31	0.006	0.009	0.012
D	3.30	3.56	3.95	0.130	0.140	0.156
E	4.06	4.32	4.60	0.160	0.170	0.181
HE	5.21	5.44	5.60	0.205	0.214	0.220
L	0.76	1.02	1.60	0.030	0.040	0.063
L1	0.51 REF			0.020 REF		

### SOLDERING FOOTPRINT\*

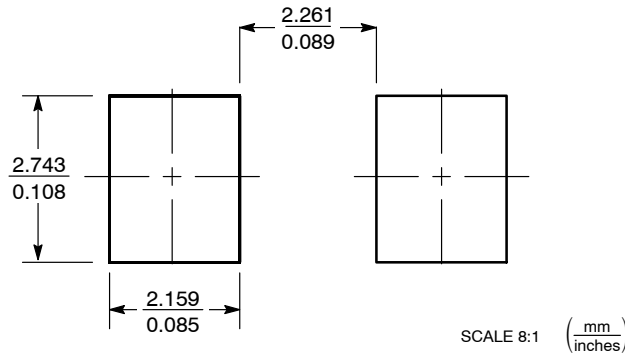

\*For additional information on our Pb-Free strategy and soldering details, please download the ON Semiconductor Soldering and Mounting Techniques Reference Manual, SOLDERRM/D.

ON Semiconductor and are registered trademarks of Semiconductor Components Industries, LLC (SCILLC). SCILLC reserves the right to make changes without further notice to any products herein. SCILLC makes no warranty, representation or guarantee regarding the suitability of its products for any particular purpose, nor does SCILLC assume any liability arising out of the application or use of any product or circuit, and specifically disclaims any and all liability, including without limitation special, consequential or incidental damages. "Typical" parameters which may be provided in SCILLC data sheets and/or specifications can and do vary in different applications and actual performance may vary over time. All operating parameters, including "Typicals" must be validated for each customer application by customer's technical experts. SCILLC does not convey any license under its patent rights nor the rights of others. SCILLC products are not designed, intended, or authorized for use as components in systems intended for surgical implant into the body, or other applications intended to support or sustain life, or for any other application in which the failure of the SCILLC product could create a situation where personal injury or death may occur. Should Buyer purchase or use SCILLC products for any such unintended or unauthorized application, Buyer shall indemnify and hold SCILLC and its officers, employees, subsidiaries, affiliates, and distributors harmless against all claims, costs, damages, and expenses, and reasonable attorney fees arising out of, directly or indirectly, any claim of personal injury or death associated with such unintended or unauthorized use, even if such claim alleges that SCILLC was negligent regarding the design or manufacture of the part. SCILLC is an Equal Opportunity/Affirmative Action Employer. This literature is subject to all applicable copyright laws and is not for resale in any manner.

### PUBLICATION ORDERING INFORMATION

**LITERATURE FULFILLMENT:**  
Literature Distribution Center for ON Semiconductor  
P.O. Box 5163, Denver, Colorado 80217 USA  
**Phone:** 303-675-2175 or 800-344-3860 Toll Free USA/Canada  
**Fax:** 303-675-2176 or 800-344-3867 Toll Free USA/Canada  
**Email:** orderlit@onsemi.com

**N. American Technical Support:** 800-282-9855 Toll Free  
USA/Canada  
**Europe, Middle East and Africa Technical Support:**  
Phone: 421 33 790 2910  
**Japan Customer Focus Center**  
Phone: 81-3-5817-1050

**ON Semiconductor Website:** [www.onsemi.com](http://www.onsemi.com)  
**Order Literature:** <http://www.onsemi.com/orderlit>  
For additional information, please contact your local Sales Representative

# Mouser Electronics

Authorized Distributor

Click to View Pricing, Inventory, Delivery & Lifecycle Information:

## ON Semiconductor:

[1SMB5913BT3G](#) [1SMB5914BT3G](#) [1SMB5915BT3G](#) [1SMB5916BT3G](#) [1SMB5917BT3G](#) [1SMB5918BT3G](#)  
[1SMB5919BT3G](#) [1SMB5920BT3G](#) [1SMB5921BT3G](#) [1SMB5922BT3G](#) [1SMB5923BT3G](#) [1SMB5924BT3G](#)  
[1SMB5925BT3G](#) [1SMB5926BT3G](#) [1SMB5928BT3G](#) [1SMB5929BT3G](#) [1SMB5930BT3G](#) [1SMB5931BT3G](#)  
[1SMB5932BT3G](#) [1SMB5933BT3G](#) [1SMB5934BT3G](#) [1SMB5935BT3G](#) [1SMB5936BT3G](#) [1SMB5937BT3G](#)  
[1SMB5938BT3G](#) [1SMB5939BT3G](#) [1SMB5940BT3G](#) [1SMB5941BT3G](#) [1SMB5942BT3G](#) [1SMB5943BT3G](#)  
[1SMB5944BT3G](#) [1SMB5945BT3G](#) [1SMB5946BT3G](#) [1SMB5947BT3G](#) [1SMB5948BT3G](#) [1SMB5949BT3G](#)  
[1SMB5951BT3G](#) [1SMB5952BT3G](#) [1SMB5953BT3G](#) [1SMB5954BT3G](#) [1SMB5955BT3G](#) [1SMB5956BT3G](#)  
[SZ1SMB5915BT3G](#) [SZ1SMB5917BT3G](#) [SZ1SMB5919BT3G](#) [SZ1SMB5922BT3G](#) [SZ1SMB5923BT3G](#)  
[SZ1SMB5924BT3G](#) [SZ1SMB5925BT3G](#) [SZ1SMB5926BT3G](#) [SZ1SMB5927BT3G](#) [SZ1SMB5928BT3G](#)  
[SZ1SMB5931BT3G](#) [SZ1SMB5932BT3G](#) [SZ1SMB5933BT3G](#) [SZ1SMB5934BT3G](#) [SZ1SMB5936BT3G](#)  
[SZ1SMB5938BT3G](#) [SZ1SMB5939BT3G](#) [SZ1SMB5944BT3G](#) [SZ1SMB5945BT3G](#) [SZ1SMB5947BT3G](#)  
[SZ1SMB5956BT3G](#) [SZ1SMB5929BT3G](#) [SZ1SMB5935BT3G](#) [SZ1SMB5941BT3G](#) [1SMB5927BT3G](#)  
[SZ1SMB5948BT3G](#) [SZ1SMB5918BT3G](#) [SZ1SMB5913BT3G](#) [SZ1SMB5921BT3G](#) [SZ1SMB5940BT3G](#)  
[SZ1SMB5916BT3G](#) [SZ1SMB5946BT3G](#) [SZ1SMB5914BT3G](#)